

Datasheet

SATADOM-MV

3ME4 series

- SATA III solution for industrial field
- Exclusive L³ architecture
- DRAM-less, 100% data integrity
- Excellent random performance
- Designed with hardware LDPC ECC engine
- Built-in Pin 8 power supply
- Hardware write protection supported



Introduction

Innodisk SATADOM-MV 3ME4 is characterized by L³ architecture with the latest SATA III (6.0GHz) Marvell NAND controller. Innodisk's exclusive L³ architecture is L² architecture multiplied LDPC (Low Density Parity Check). L² (Long Life) architecture is a 4K mapping algorithm that reduces WAF and features a real-time wear leveling algorithm to provide high performance and prolong lifespan with exceptional reliability.

Innodisk SATADOM-MV 3ME4 is designed for industrial field, and supports several standard features, including TRIM, NCQ, and S.M.A.R.T. In addition, Innodisk's exclusive industrial-oriented firmware provides a flexible customization service, making it perfect for a variety of industrial applications.

The innovative Pin 8 uses the SATA connector itself as a power supply to drive the device without external cables. It could be connected directly to the SATA on-board socket on customer's system without additional power cable. Besides, the booting time for operation and the power consumption is less than hard disk drive (HDD), and can work under harsh environment compile with ATA protocol, no additional drives are required, and the SSD can be configured as a boot device or data storage device.

SATADOM-MV

3ME4 series

Contact us for more information about the SATADOM-MV 3ME4.

Innodisk is a service-driven provider of industrial embedded flash storage and Dram products and technologies, with a focus on the cloud computing, industrial/embedded, and aerospace and defense industries.

Diagram

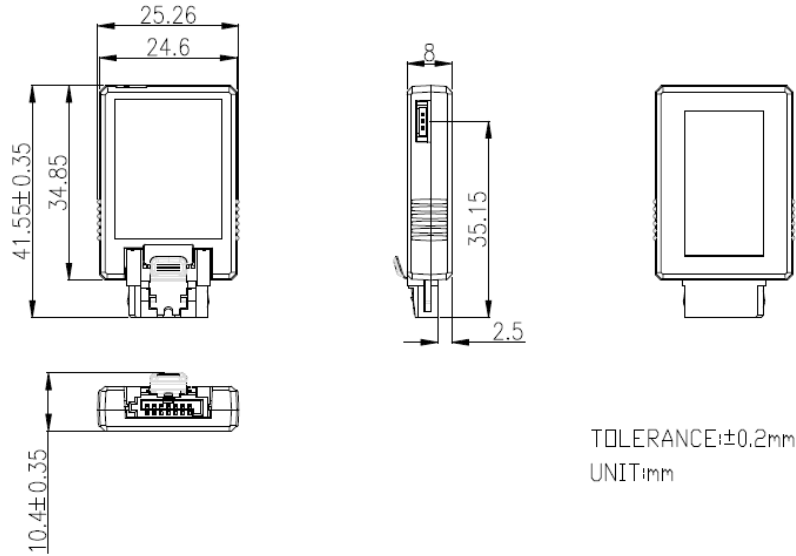

Headquarters (Taiwan)

5F., No. 237, Sec. 1, Datong Rd.,
Xizhi Dist., New Taipei City,
Taiwan (R.O.C.)
Tel: +886-2-7703-3000
Email: sales@innodisk.com

Branch Offices:

USA
usasales@innodisk.com
+1-510-770-9421
Europe
esusales@innodisk.com
+31-40-3045-400
Japan
jpsales@innodisk.com
+81-3-6667-0161
China
sales_cn@innodisk.com
+86-755-21673689
www.innodisk.com

© 2017 Innodisk Corporation.
All right reserved. Specifications
are subject to change without
prior notice.

20170210

Specifications

Interface	SATA III
Flash Type	MLC
Capacity	8GB~128GB
Max. Channels	2
Sequential R/W (MB/sec, max.)	430/125
Max. Power Consumption	1.08W (5V x 216mA)
Thermal Sensor	√
Extended DRAM buffer	-
H/W Write Protect	√
ATA Security	√
S.M.A.R.T.	√
Dimension (WxLxH)	41.55 x 25.26 x 10.4 mm
Environment	Vibration: 20G @7~2000Hz Shock: 1500G @ 0.5ms Storage Temperature: -55°C ~ +95°C MTBF: 3 million hours

Ordering Information

	8GB	16GB	32GB	64GB	128GB
Standard Grade (0°C ~ +70°C)	DESMV-08GM41BC1SC*	DESMV-16GM41BC1DC*	DESMV-32GM41BC1DC*	DESMV-64GM41BC1DC*	DESMV-A28M41BC1DC*
Industrial Grade (-40°C ~ +85°C)	DESMV-08GM41BW1SC*	DESMV-16GM41BW1DC*	DESMV-32GM41BW1DC*	DESMV-64GM41BW1DC*	DESMV-A28M41BW1DC*

*=A-> Pin 8+ power cable
*=B-> Pin 8+ Pin 7

innodisk

www.innodisk.com