

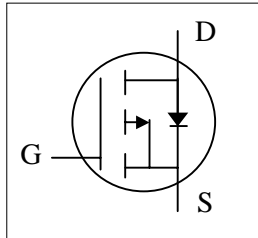

- ▼ Simple Drive Requirement
- ▼ 2.5V Gate Drive Capability



BV_{DSS}	-20V
$R_{DS(ON)}$	150mΩ
I_D	-10A

www.DataSheet4U.com

Description

The Advanced Power MOSFETs from APEC provide the designer with the best combination of fast switching, low on-resistance and cost-effectiveness.

This device is suited for low voltage and battery power applications.

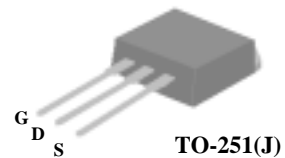
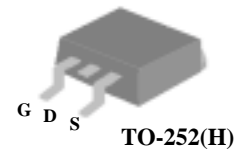

Absolute Maximum Ratings

Symbol	Parameter	Rating	Units
V_{DS}	Drain-Source Voltage	- 20	V
V_{GS}	Gate-Source Voltage	± 12	V
$I_D @ T_A=25^{\circ}C$	Continuous Drain Current, V_{GS} @ 10V	-10	A
$I_D @ T_A=100^{\circ}C$	Continuous Drain Current, V_{GS} @ 10V	-6.2	A
I_{DM}	Pulsed Drain Current ¹	-24	A
$P_D @ T_A=25^{\circ}C$	Total Power Dissipation	25	W
	Linear Derating Factor	0.01	W/°C
T_{STG}	Storage Temperature Range	-55 to 150	°C
T_J	Operating Junction Temperature Range	-55 to 150	°C

Thermal Data

Symbol	Parameter	Value	Unit
Rthj-c	Thermal Resistance Junction-case	Max. 5.0	°C/W
Rthj-a	Thermal Resistance Junction-ambient	Max. 110	°C/W



AP3310H/J

Electrical Characteristics @T_j=25°C(unless otherwise specified)

Symbol	Parameter	Test Conditions	Min.	Typ.	Max.	Units
BV _{DSS}	Drain-Source Breakdown Voltage	V _{GS} =0V, I _D =-250uA	-20	-	-	V
ΔBV _{DSS} /ΔT _j	Breakdown Voltage Temperature Coefficient	Reference to 25°C, I _D =-1mA	-	-0.1	-	V/°C
R _{DS(ON)}	Static Drain-Source On-Resistance	V _{GS} =-4.5V, I _D =-2.8A	-	-	150	mΩ
		V _{GS} =-2.5V, I _D =-2.0A	-	-	250	mΩ
V _{GS(th)}	Gate Threshold Voltage	V _{DS} =V _{GS} , I _D =-250uA	-0.5	-	-	V
g _{fs}	Forward Transconductance	V _{DS} =-5V, I _D =-2.8A	-	4.4	-	S
I _{DSS}	Drain-Source Leakage Current (T _j =25°C)	V _{DS} =-20V, V _{GS} =0V	-	-	-1	uA
	Drain-Source Leakage Current (T _j =150°C)	V _{DS} =-16V, V _{GS} =0V	-	-	-25	uA
I _{GSS}	Gate-Source Leakage	V _{GS} = ± 12V	-	-	±100	nA
Q _g	Total Gate Charge ²	I _D =-2.8A	-	6	-	nC
Q _{gs}	Gate-Source Charge	V _{DS} =-6V	-	1.5	-	nC
Q _{gd}	Gate-Drain ("Miller") Charge	V _{GS} =-5V	-	0.6	-	nC
t _{d(on)}	Turn-on Delay Time ²	V _{DS} =-6V	-	25	-	ns
t _r	Rise Time	I _D =-1A	-	60	-	ns
t _{d(off)}	Turn-off Delay Time	R _G =6Ω, V _{GS} =-5V	-	70	-	ns
t _f	Fall Time	R _D =6Ω	-	60	-	ns
C _{iss}	Input Capacitance	V _{GS} =0V	-	300	-	pF
C _{oss}	Output Capacitance	V _{DS} =-6V	-	180	-	pF
C _{rss}	Reverse Transfer Capacitance	f=1.0MHz	-	60	-	pF

Source-Drain Diode

Symbol	Parameter	Test Conditions	Min.	Typ.	Max.	Units
I _S	Continuous Source Current (Body Diode)	V _D =V _G =0V , V _S =-1.2V	-	-	-10	A
I _{SM}	Pulsed Source Current (Body Diode) ¹		-	-	-24	A
V _{SD}	Forward On Voltage ²	T _j =25°C, I _S =-10A, V _{GS} =0V	-	-	-1.2	V

Notes:

- 1.Pulse width limited by safe operating area.
- 2.Pulse width ≤300us , duty cycle ≤2%.

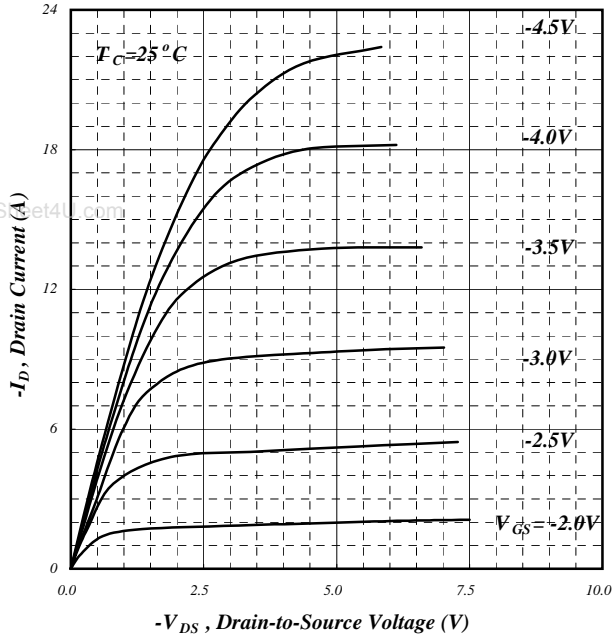

Fig 1. Typical Output Characteristics

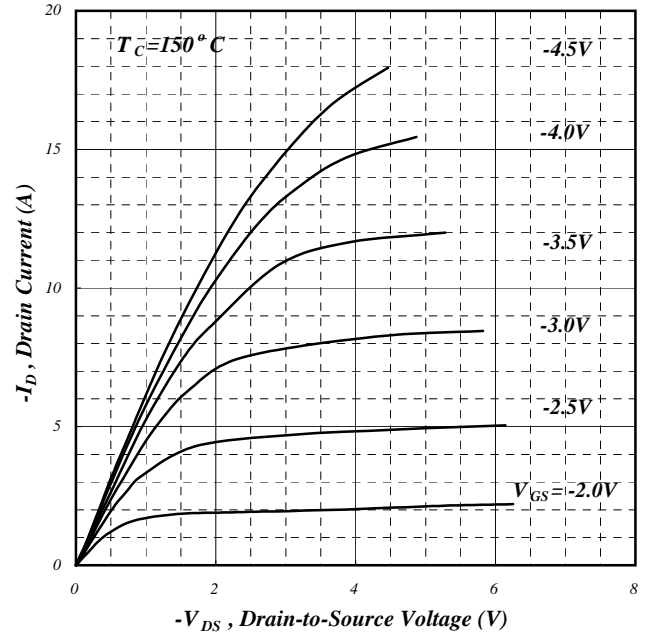

Fig 2. Typical Output Characteristics

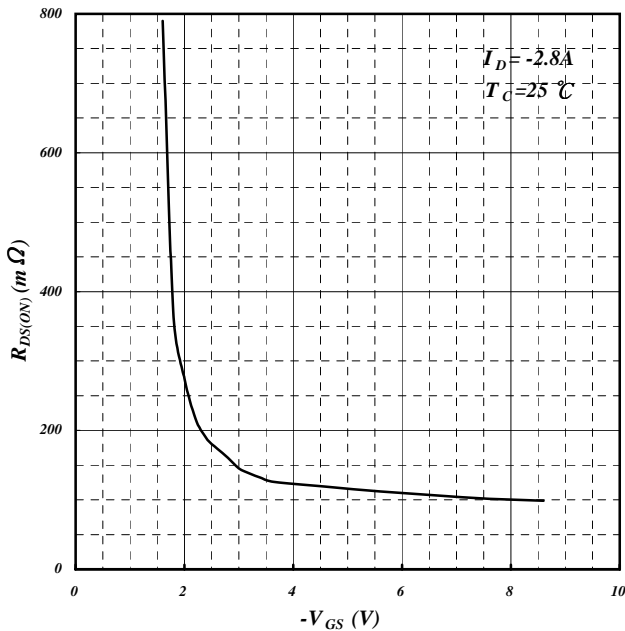

Fig 3. On-Resistance v.s. Gate Voltage

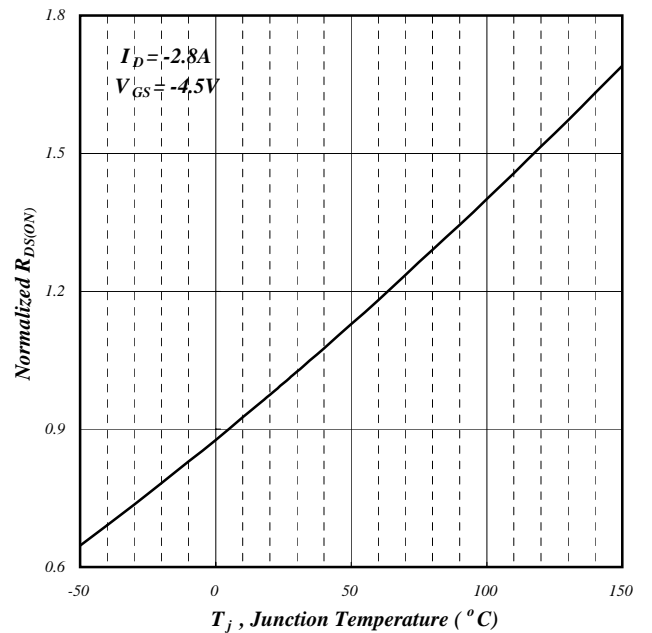

Fig 4. Normalized On-Resistance v.s. Junction Temperature

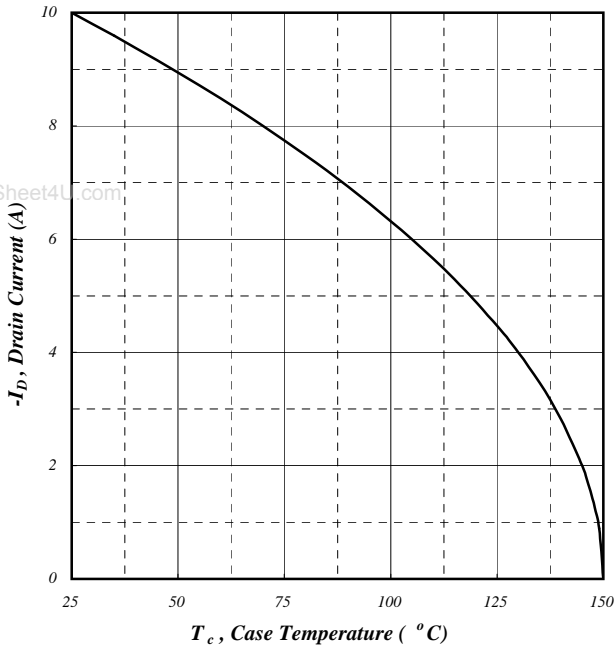

Fig 5. Maximum Drain Current v.s. Case Temperature

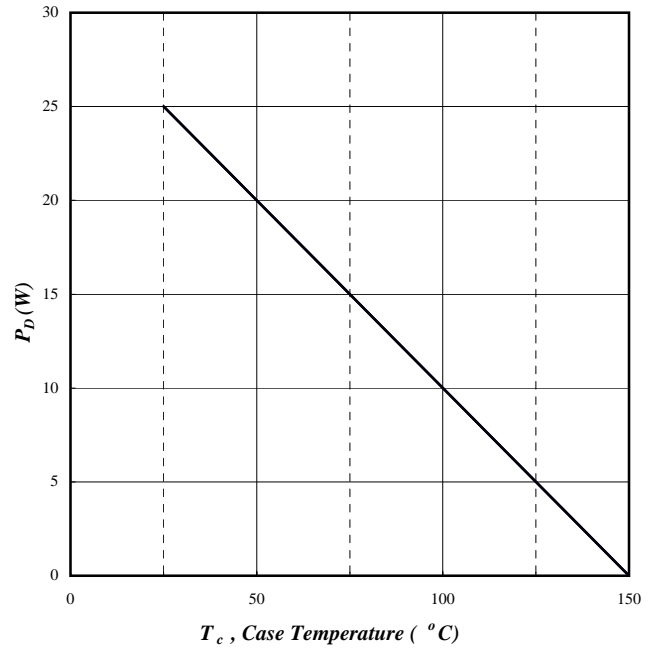

Fig 6. Typical Power Dissipation

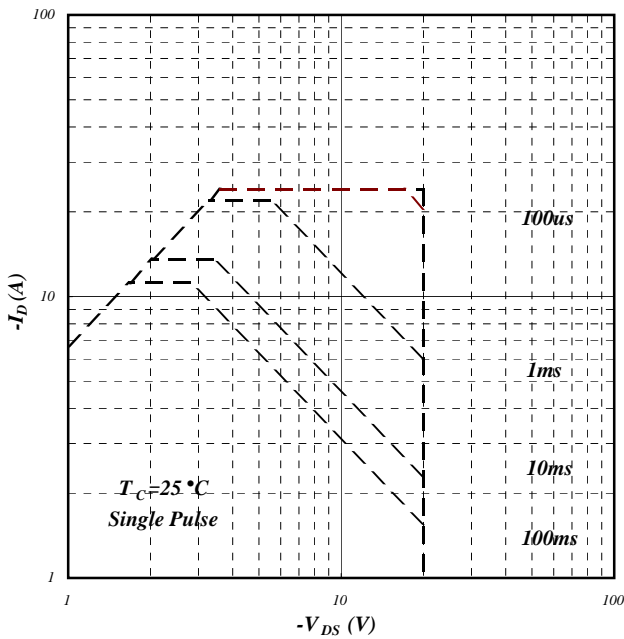

Fig 7. Maximum Safe Operating Area

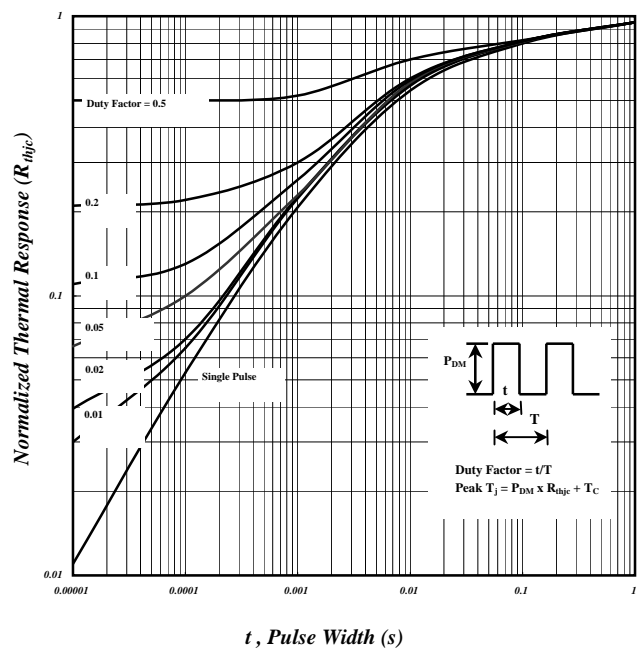

Fig 8. Effective Transient Thermal Impedance

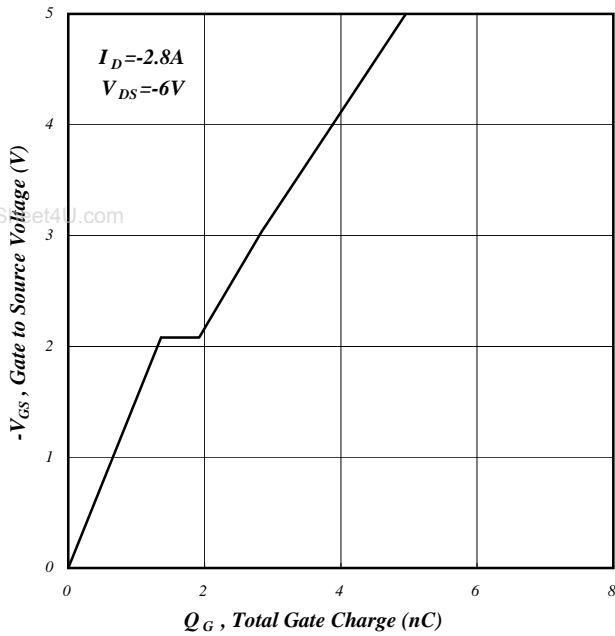

Fig 9. Gate Charge Characteristics

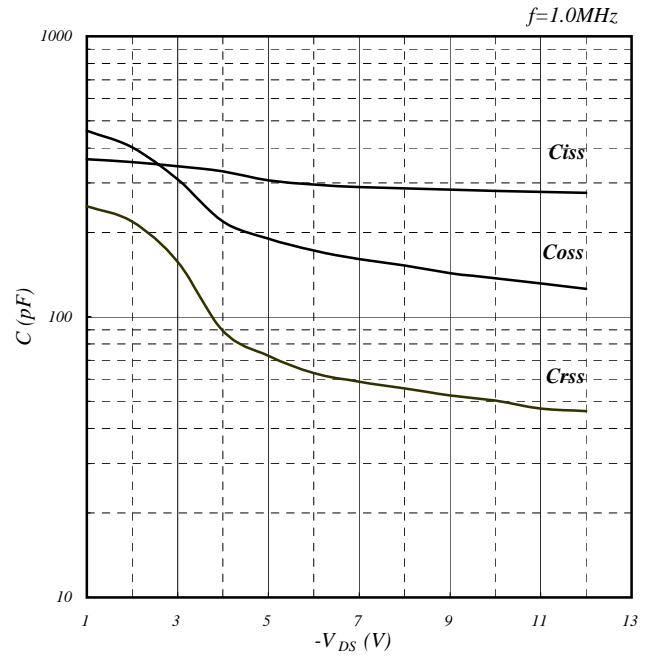

Fig 10. Typical Capacitance Characteristics

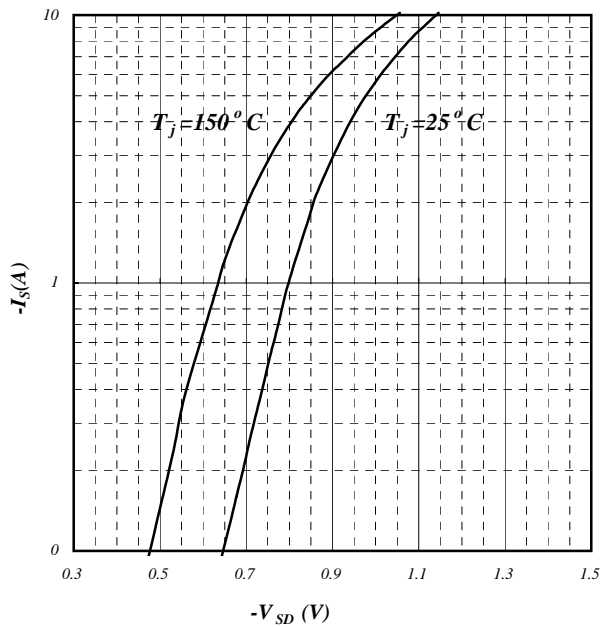

Fig 11. Forward Characteristic of Reverse Diode

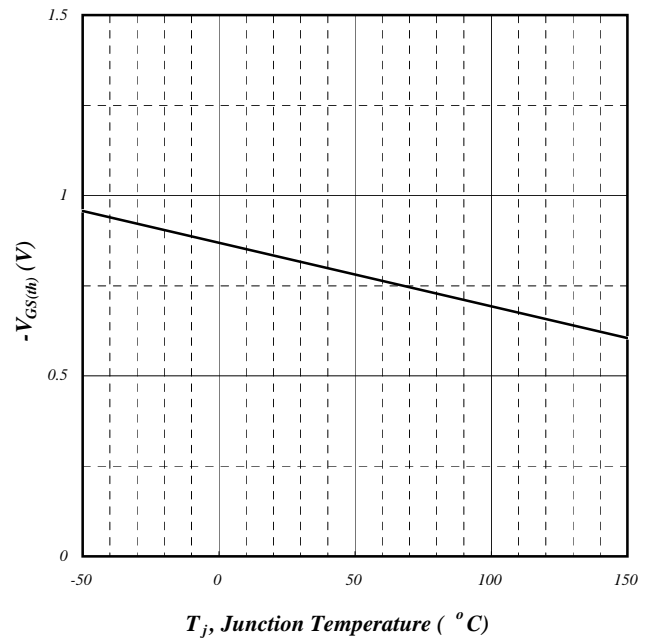

Fig 12. Gate Threshold Voltage v.s. Junction Temperature

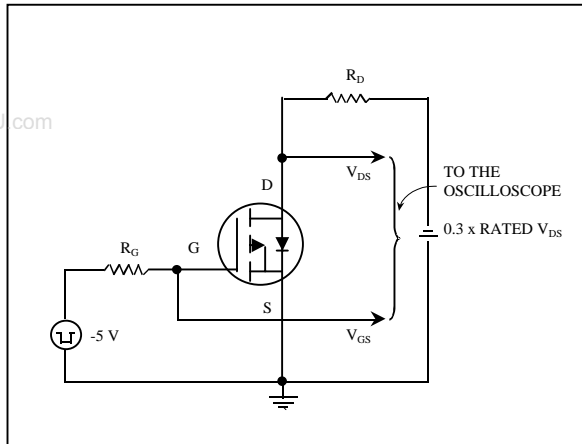

Fig 13. Switching Time Circuit

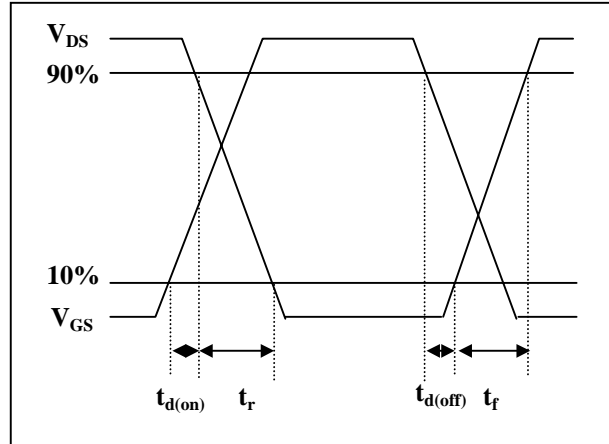

Fig 14. Switching Time Waveform

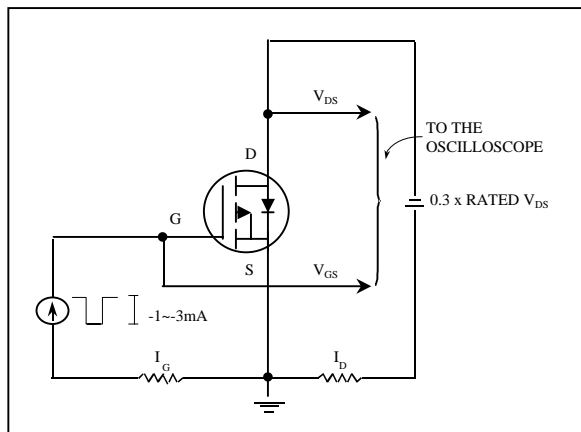

Fig 15. Gate Charge Circuit

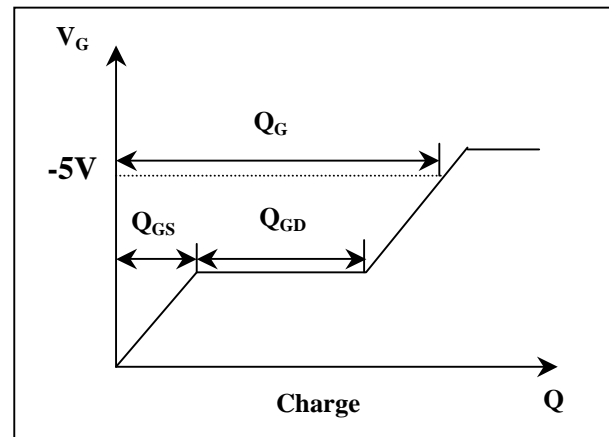

Fig 16. Gate Charge Waveform