

AHB

HOME FURNITURE COLLECTIONS

ASSEMBLY INSTRUCTIONS

MADISON STOOL

LOOSELY ATTACH EACH SCREW UNTIL FRAME IS ASSEMBLED THEN TIGHTEN WHEN COMPLETE

1

STEP 1

1) Attach swivel plate (D) to the bar stool base using the four bolts (A) and then lock washer (B) & flat washer (C). Tighten all bolts evenly and then turn each bolt 1/4 turn for final fasten.

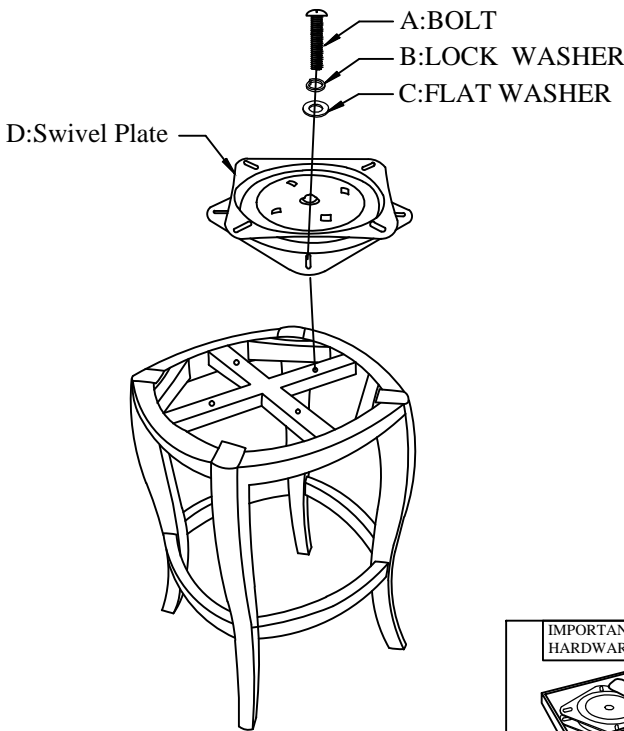

2



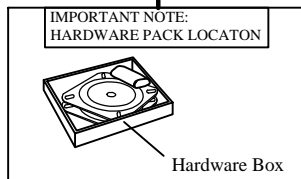
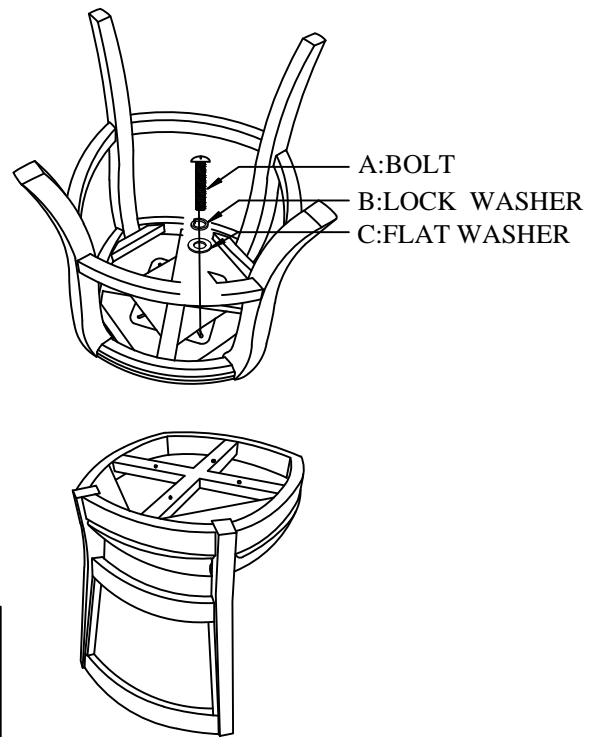

STEP 2

2) Attach bar stool seat to swivel plate, which is now attached to the bar stool base. Attach bar stool seat using four bolts (A) and then lock washers (B) & flat washers (C). Tighten all bolts evenly and then turn each bolt 1/4 turn evenly for final fasten.

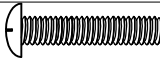

* PLEASE READ INSTRUCTION PRINTED ON SWIVEL PLATE
HARDWARE PACK
CHECK THAT THE FOLLOWING PARTS ARE IN CARTON

PARTS LIST

A		BOLT	1/4"*7/8"	8 PCS
B		LOCK WASHER	1/4"	8 PCS
C		FLAT WASHER	1/4"*16mm	8 PCS
D		SWIVEL PLATE	8"*8"*22mm	1 PC

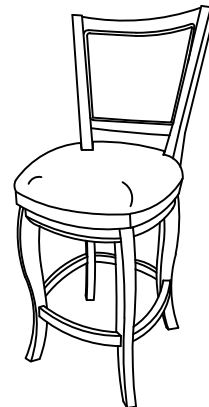

MADE IN CHINA

DO YOU HAVE A QUESTION CONCERNING YOUR AMERICAN HERITAGE BILLIARDS PRODUCT? PLEASE CONTACT THE RETAILER YOU PURCHASED YOUR FURNITURE FROM TO GET MORE INFORMATION ON THE PRODUCT. IF YOU CANNOT CONTACT THE RETAILER YOU PURCHASED FROM, PLEASE SEND US AN INQUIRY TO OUR WEBSITE AND WE'LL DO OUR BEST TO HELP. THANK YOU FOR YOUR SUPPORT!