

— EST. 1987 —

A H BHOME FURNITURE COLLECTIONS
ASSEMBLY INSTRUCTIONS







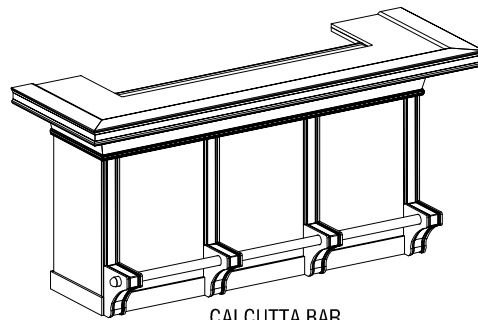



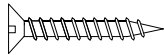

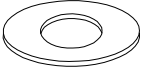
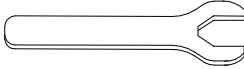
CALCUTTA BAR

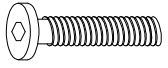
DO NOT SET POWER DRILL ABOVE LEVEL 4

LOOSELY ATTACH EACH SCREW UNTIL FRAME IS ASSEMBLED, THEN TIGHTEN WHEN COMPLETE

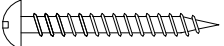

CALCUTTA BAR

	HARDWARE LIST	QTY	OUTLOOK
A	SCREW (1")	12	 SCALE 1:1
B	HEX NUT(ϕ 5/16")	8	 SCALE 1:1
C	LOCK WASHER(ϕ 5/16")	8	 SCALE 1:1
D	FLAT WASHER (ϕ 5/16"*22mm)	8	 SCALE 1:1
E	WRENCH	1	
F	ALLEN KEY	1	
G	JCBC BOLT(ϕ 1/4"*1")	4	 SCALE 1:1
H	FOOT RAIL	1	
I	FOOT RAIL COVER	2	
J	CUP HOLDER	4	
K	BAR TOP SCREW (1-1/4")	8	 SCALE 1:1
L	HANDLES	4	
M	DOOR BOLT (ϕ 5/32"*1-1/8")	4	
N	DRAWER BOLT (ϕ 5/32"*1-1/2")	4	

— EST. 1987 —

A H B

HOME FURNITURE COLLECTIONS

ASSEMBLY INSTRUCTIONS

CALCUTTA BAR

DO NOT SET POWER DRILL ABOVE LEVEL 4

LOOSELY ATTACH EACH SCREW UNTIL FRAME IS ASSEMBLED, THEN TIGHTEN WHEN COMPLETE

STEP 1:

REMOVE 2 CORNER SUPPORT PANEL FOR NEXT STEP.

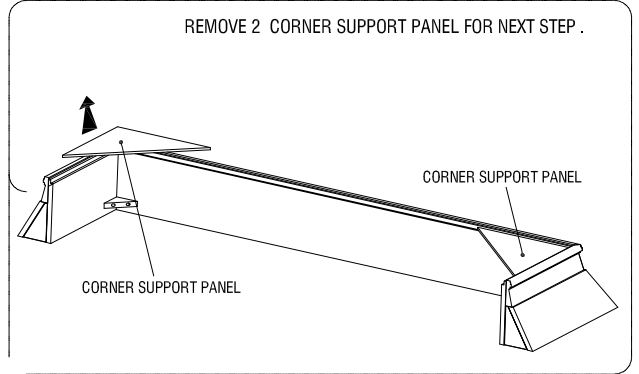

STEP 5:

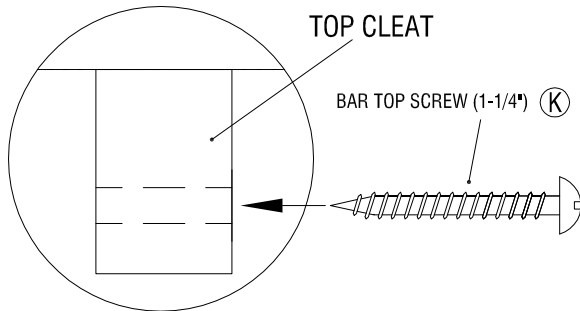

STEP 2:

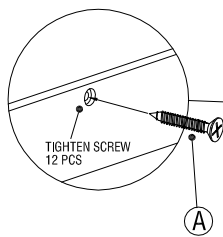

STEP 4:

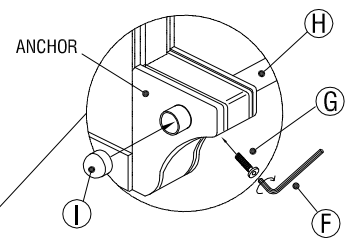

STEP 3:

