

— EST. 1987 —

**A H B**

HOME FURNITURE COLLECTIONS

ASSEMBLY INSTRUCTIONS









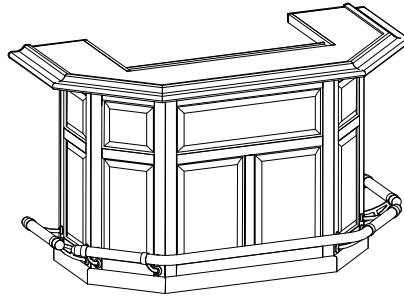

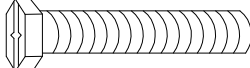

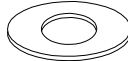
AUGUSTA BAR

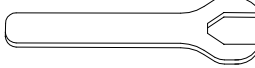
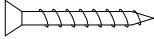
DO NOT SET POWER DRILL ABOVE LEVEL 4

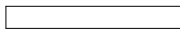
LOOSELY ATTACH EACH SCREW UNTIL FRAME IS ASSEMBLED, THEN TIGHTEN WHEN COMPLETE

2-1

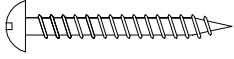

	HARDWARE LIST	QTY	OUTLOOK
A	HEX BOLT( $\phi$ 5/16"*1-1/8"L)	8	
B	LOCK WASHER( $\phi$ 5/16")	8	
C	FLAT WASHER( $\phi$ 5/16"*19mm)	8	
D	ANCHOR	8	
E	WRENCH(12mm)	1	
F	P.H SCREW( $\phi$ 8*1")	8	
G	FOOT RAIL	1	
H	FOOT RAIL	2	
I	FOOT RAIL COVER	6	
J	SET SCREW(M5*8mm)	8	 
K	CUP HOLDER	4	
L	BAR TOP SCREW ( $\phi$ 8*1-1/4")	8	
M	HANDLES	2	
N	DOOR BOLT( $\phi$ 5/32"*1")	4	

— EST. 1987 —

# A H B

HOME FURNITURE COLLECTIONS

## ASSEMBLY INSTRUCTIONS

### AUGUSTA BAR

DO NOT SET POWER DRILL ABOVE LEVEL 4

LOOSELY ATTACH EACH SCREW UNTIL FRAME IS ASSEMBLED, THEN TIGHTEN WHEN COMPLETE

2-2

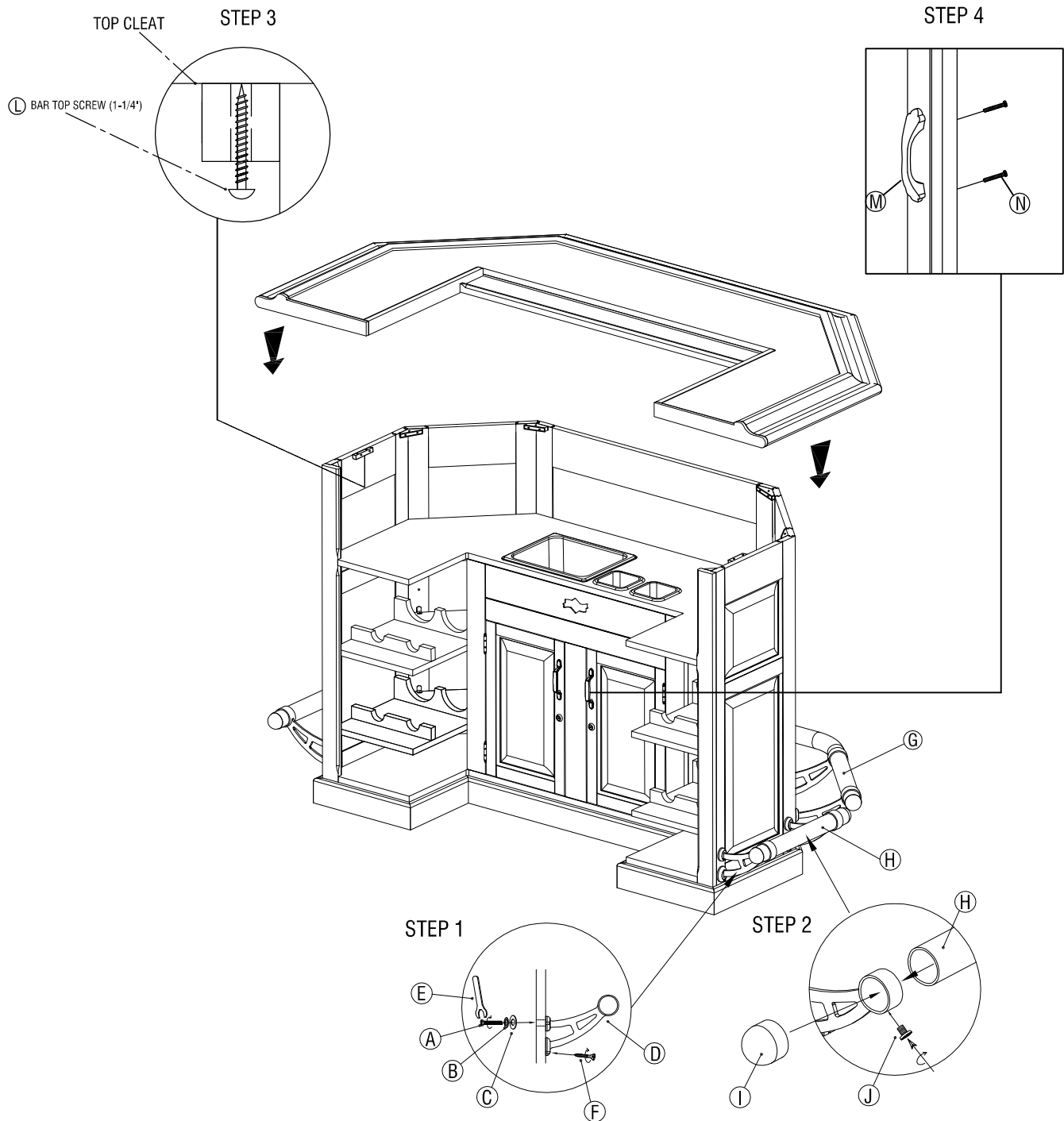

**\* IMPORTANT**  
 PLS STRONGLY TIGHTEN USING SCREW DRIVER  
 FOOT POLE IS LOCATED UNDERNEATH THE BASE OF THE BAR.