

**FLANGES
SOBREPOSTO - WELDING NECK - CEGO - ROSCADO - LAP JOINT - DE ENCAIXE - LONG WN**

150 LB.

ANSI - B- 16.5

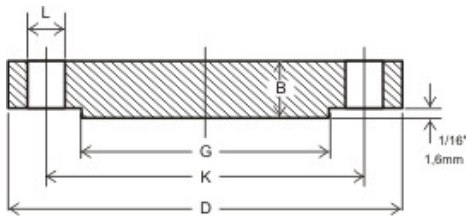

Flange cego

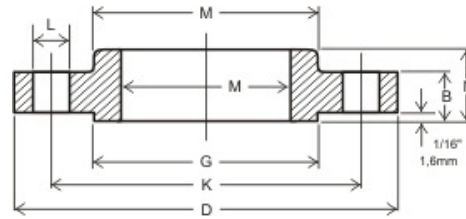

Flange sobreposto

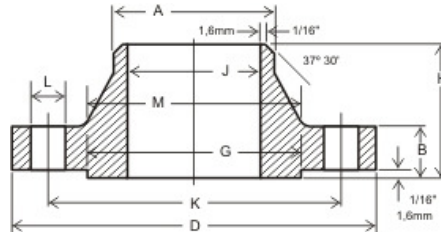

Flange com pescoço

Diâmetro Nominal	Medida em	Medidas Comuns							Furos				
		D	G	M	B	Nº	L	K	J	E	C	F	V
1/2"	polegada	3 1/2	1 3/8	1 3/16	7/16	4	5/8	2 3/8	0.62	Flange roscado 150 lb. sem encaixe	0.88	0.62	0.90
	mm	88,9	34,9	30,2	11,1		15,9	60,3	15,7		22,4	15,7	22,9
3/4"	polegada	3 7/8	1 11/16	1 1/2	1/2	4	5/8	2 3/4	0.82		1.09	0.82	1.11
	mm	98,4	42,9	38,1	12,7		15,9	69,8	20,8		27,7	20,8	28,2
1"	polegada	4 1/4	2	1 15/16	9/16	4	5/8	3 1/8	1.05		1.36	1.05	1.38
	mm	108	50,8	49,2	14,3		15,9	79,4	26,7		34,5	26,7	35,1
1 1/4"	polegada	4 5/8	2 1/2	2 5/16	5/8	4	5/8	3 1/2	1.38		1.70	1.38	1.72
	mm	117	63,5	58,7	15,9		15,9	88,9	35,1		43,2	35,1	43,7
1 1/2"	polegada	5	2 7/8	2 9/16	11/16	4	5/8	3 7/8	1.61		1.95	1.61	1.97
	mm	127	73,0	65,1	17,5		15,9	98,4	40,9		49,5	40,9	50,0
2"	polegada	6	3 5/8	3 1/16	3/4	4	3/4	4 3/4	2.07		2.44	2.07	2.46
	mm	152	92,1	77,8	19,0		19,0	121	52,6		62,0	52,6	62,5
2 1/2"	polegada	7	4 1/8	3 9/16	7/8	4	3/4	5 1/2	2.47		2.94	2.47	2.97
	mm	178	105	90,5	22,2		19,0	140	62,7		74,7	62,7	75,4
3"	polegada	7 1/2	5	4 1/4	15/16	4	3/4	6	3.07		3.57	3.07	3.60
	mm	190	127	108	23,8		19,0	152	78,0		90,7	78,0	91,4
3 1/2"	polegada	8 1/2	5 1/2	4 13/16	15/16	8	3/4	7	3.55		4.07	3.55	4.10
	mm	216	140	122	23,8		19,0	178	90,2		103	90	104
4"	polegada	9	6 3/16	5 5/16	15/16	8	3/4	7 1/2	4.03		4.57	4.03	4.60
	mm	229	157	135	23,8		19,0	190	102		116	102,4	117
5"	polegada	10	7 5/16	6 7/16	15/16	8	7/8	8 1/2	5.05		5.66	5.05	5.69
	mm	254	186	164	23,8		22,2	216	128		144	128,3	145
6"	polegada	11	8 1/2	7 9/16	1	8	7/8	9 1/2	6.07		6.72	6.07	6.75
	mm	279	216	192	25,4		22,2	241	154		171	154,2	171
8"	polegada	13 1/2	10 5/8	9 11/16	1 1/8	8	7/8	11 3/4	7.98	8.72	7.98	8.75	
	mm	343	270	246	28,6		22,2	298	203	221	202,7	222	
10"	polegada	16	12 3/4	12	1 3/16	12	1	14 1/4	10.02	10.88	10.02	10.92	
	mm	406	324	305	30,2		25,4	362	255	276	25,45	277	
12"	polegada	19	15	14 3/8	1 1/4	12	1	17	12.00	12.88	12	12.92	
	mm	483	381	365	31,8		25,4	432	305	327	304,8	328	
14"	polegada	21	16 1/4	15 3/4	1 3/8	12	1 1/8	18 3/4	13.25	14.14	13.25	14.18	
	mm	533	413	400	34,9		28,6	476	336,5	359	336,5	360	
16"	polegada	23 1/2	18 1/2	18	1 7/16	16	1 1/8	21 1/4	15.25	16.16	15.25	16.19	
	mm	597	470	457	36,5		28,6	540	387	410	387	411	
18"	polegada	25	21	19 7/8	1 9/16	16	1 1/4	22 3/4	17.25	18.18	17.25	18.20	
	mm	635	533	505	39,7		31,8	578	438	462	438,1	462	
20"	polegada	27 1/2	23	22	1 11/16	20	1 1/4	25	19.25	20.20	19.25	20.25	
	mm	698	584	559	42,9		31,8	635	489	513	488,9	514	
24"	polegada	32	27 1/4	26 1/8	1 7/8	20	1 3/8	29 1/2	23.25	24.25	23.25	24.25	
	mm	813	692	664	47,6		34,9	749	590,5	616	590,5	616	

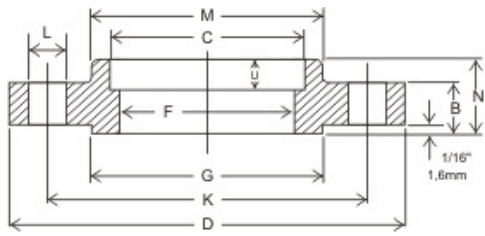

Flange de encaixe

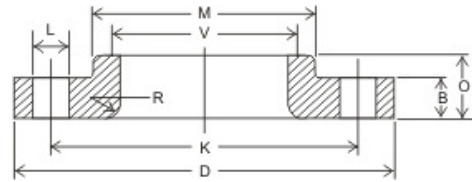

Flange solto

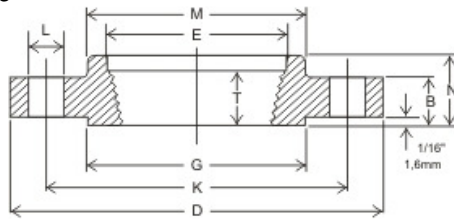

Flange roscado

Medidas diversas							Peso aprox. Pounds e quilos				Medidas em	Diâmetro nominal
A	H	N	O	T	U	R	Sobrepostos de encaixe, roscados	com pescoço	soltos	cegos		
0.84	1 7/8	5/8	5/8	5/8	3/8	1/8	1	2	1	1	polegada	1/2"
21,3	47,6	15,9	15,9	15,9	9,52	3,18	0,5	0,9	0,5	0,5	mm	
1.05	2 1/16	5/8	5/8	5/8	7/16	1/8	2	2	2	2	polegada	3/4"
26,7	52,4	15,9	15,9	15,9	11,1	3,18	0,9	0,9	0,9	0,9	mm	
1.32	2 3/16	11/16	11/16	11/16	1/2	1/8	2	3	2	2	polegada	1"
33,5	55,6	17,5	17,5	17,5	12,7	3,18	0,9	1,4	0,9	0,9	mm	
1.66	2 1/4	13/16	13/16	13/16	9/16	3/16	3	3	3	3	polegada	1 1/4"
42,2	57,2	20,6	20,6	20,6	14,3	4,76	1,4	1,4	1,4	1,4	mm	
1.90	2 7/16	7/8	7/8	7/8	5/8	1/4	3	4	3	4	polegada	1 1/2"
48,3	61,9	22,2	22,2	22,2	15,9	6,35	1,4	1,8	1,4	1,8	mm	
2.38	2 1/2	1	1	1	11/16	5/16	5	6	5	5	polegada	2"
60,5	63,5	25,4	25,4	25,4	17,5	7,94	2,3	2,7	2,3	2,3	mm	
2.88	2 3/4	1 1/8	1 1/8	1 1/8	3/4	5/16	7	8	7	7	polegada	2 1/2"
73,2	69,8	28,6	28,6	28,6	19,0	7,94	3,2	3,6	3,2	3,2	mm	
3.50	2 3/4	1 3/16	1 3/16	1 3/16	13/16	3/8	8	10	8	9	polegada	3"
88,9	69,8	30,2	30,2	30,2	20,6	9,52	3,6	4,5	3,6	4,1	mm	
4.00	2 13/16	1 1/4	1 1/4	1 1/4	7/8	3/8	11	12	11	13	polegada	3 1/2"
102	71,4	31,8	31,8	31,8	22,2	9,52	5,0	5,4	5	5,9	mm	
4.50	3	1 5/16	1 5/16	1 5/16	15/16	7/16	13	15	13	17	polegada	4"
114	76,2	33,3	33,3	33,3	23,8	11,1	5,9	6,8	5,9	7,7	mm	
5.56	3 1/2	1 7/16	1 7/16	1 7/16	15/16	7/16	15	19	15	20	polegada	5"
141	88,9	36,5	36,5	36,5	23,8	11,1	6,8	8,6	6,8	9,1	mm	
6.62	3 1/2	1 9/16	1 9/16	1 9/16	1 1/16	1/2	19	24	19	26	polegada	6"
168	88,9	39,7	39,7	39,7	27	12,7	8,6	10,9	8,6	11,8	mm	
8.62	4	1 3/4	1 3/4	1 3/4	1 1/4	1 1/2	30	39	30	45	polegada	8"
219	102	44,4	44,4	44,4	31,7	12,7	13,6	17,7	13,6	20,4	mm	
10.75	4	1 15/16	1 15/16	1 15/16	1 15/16	1/2	43	52	43	70	polegada	10"
273	102	49,2	49,2	49,2	33,3	12,7	19,5	23,6	19,5	31,8	mm	
12.75	4 1/2	2 3/16	2 3/16	2 3/16	1 9/16	1/2	64	80	64	110	polegada	12"
324	114	55,6	55,6	55,6	39,7	12,7	29,0	36,3	29,0	49,9	mm	
14.00	5	2 1/4	3 1/8	2 1/4	1 5/8	1/2	90	110	105	140	polegada	14"
356	127	57,2	79,4	57,2	41,3	12,7	41,0	50,0	47,6	63,5	mm	
16.00	5	2 1/2	3 7/16	2 1/2	1 3/4	1/2	98	140	140	180	polegada	16"
406	127	63,5	87,3	63,5	44,4	12,7	44,5	64,0	63,5	81,6	mm	
18.00	5 1/2	2 11/16	3 13/16	2 11/16	1 15/16	1/2	130	150	160	220	polegada	18"
457	140	68,3	96,8	68,3	49,2	12,7	59,0	68,0	72,6	99,8	mm	
20.00	5 11/16	2 7/8	4 1/16	2 1/8	2 1/8	1/2	165	180	195	285	polegada	20"
508	144	73,0	103	73,0	54	12,7	75,0	81,6	88,5	129	mm	
24.00	6	3 1/4	4 3/4	3 1/4	2 1/2	1/2	220	260	275	430	polegada	24"
610	152	82,6	111	82,6	63,5	12,7	99,8	118	125	195	mm	

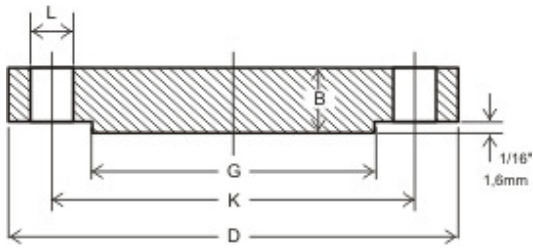

Flange cego

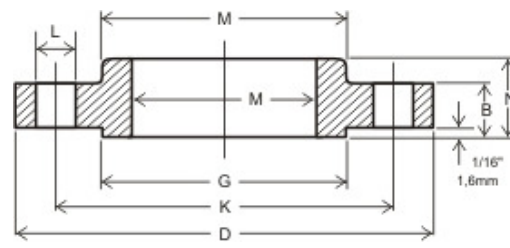

Flange sobreposto

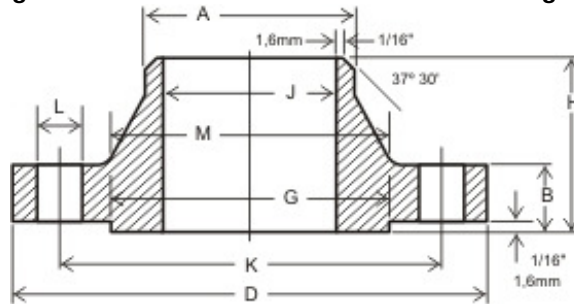

Flange com pescoço

Diâmetro Nominal	Medida em	Medidas Comuns					Furos						
		D	G	M	B	Nº	L	K	J	E	C	F	V
1/2"	polegada	3 3/4	1 3/8	1 1/2	9/16	4	5/8	2 5/8	0.62	0.93	0.88	0.62	0.90
	mm	95,2	34,9	38,1	14,3		15,9	66,7	15,7	23,6	22,4	15,7	22,9
3/4"	polegada	4 5/8	1 11/16	1 7/8	5/8	4	3/4	3 1/4	0.82	1.14	1.09	0.82	1.11
	mm	117	42,9	47,6	15,9		19,0	82,6	20,8	29,0	27,7	20,8	28,2
1"	polegada	4 7/8	2	2 1/8	11/16	4	3/4	3 1/2	1.05	1.41	1.36	1.05	1.38
	mm	124	50,8	54,0	17,5		19,0	88,9	26,7	35,8	34,5	26,7	35,1
1 1/4"	polegada	5 1/4	2 1/2	2 1/2	3/4	4	3/4	3 7/8	1.38	1.75	1.70	1.38	1.72
	mm	133	63,5	63,5	19,0		19,0	98,4	35,1	44,4	43,2	35,1	43,7
1 1/2"	polegada	6 1/8	2 7/8	2 3/4	13/16	4	7/8	4 1/2	1.61	1.99	1.95	1.61	1.97
	mm	156	73,0	69,8	20,6		22,2	114	40,9	50,5	49,5	40,9	50,0
2"	polegada	6 1/2	3 5/8	3 5/16	7/8	8	3/4	5	2.07	2.50	2.44	2.07	2.46
	mm	165	92,1	84,1	22,2		19,0	127	52,6	63,5	62,0	52,6	62,5
2 1/2"	polegada	7 1/2	4 1/8	3 5/16	1	8	7/8	5 7/8	2.47	3.00	2.94	2.47	2.97
	mm	190	105	100	25,4		22,2	149	62,7	76,2	74,7	62,7	75,4
3"	polegada	8 1/4	5	4 5/8	1 1/8	8	7/8	6 5/8	3.07	3.63	3.57	3.07	3.60
	mm	210	127	117	28,6		22,2	168	78,0	92,2	90,7	78,0	91,4
3 1/2"	polegada	9	5 1/2	5 1/4	1 3/16	8	7/8	7 1/4	3.55	4.13	4.07	3.55	4.10
	mm	229	140	133	30,2		22,2	184	90,2	105	103	90,2	104
4"	polegada	10	6 3/16	5 3/4	1 1/4	8	7/8	7 7/8	4.03	4.63	4.57	4.03	4.60
	mm	254	157	146	31,8		22,2	200	102	118	116	102,4	117
5"	polegada	11	7 5/16	7	1 3/8	8	7/8	9 1/4	5.05	5.69	5.66	x	5.69
	mm	279	186	178	34,9		22,2	235	128	145	144	x	145
6"	polegada	12 1/2	8 1/2	8 1/8	1 7/16	12	7/8	10 5/8	6.07	6.75	6.72	x	6.75
	mm	318	216	206	36,5		22,2	270	154	171	171	x	171
8"	polegada	15	10 5/8	10 1/4	1 5/8	12	1	13	7.98	8.75	8.72	x	8.75
	mm	381	270	260	41,3		25,4	330	203	223	221	x	222
10"	polegada	17 1/2	12 3/4	12 5/8	1 7/8	16	1 1/4	15 1/4	10.02	10.88	10.88	x	10.92
	mm	444	324	321	47,6		28,6	387	255	276	276	x	277
12"	polegada	20 1/2	15	14 3/4	2	16	1 1/4	17 3/4	12.00	12.94	12.88	x	12.92
	mm	521	381	375	50,8		31,8	451	305	329	327	x	328
14"	polegada	23	16 1/4	16 3/4	2 1/8	20	1 1/4	20 1/4	13.29	14.19	14.14	x	14.18
	mm	584	413	425	54		31,8	514	336,5	360	359	x	360
16"	polegada	25 1/2	18 1/2	19	2 1/4	20	1 3/8	22 1/2	15.25	16.19	16.16	x	16.19
	mm	648	470	483	57,2		34,9	572	387	411	410	x	411
18"	polegada	28	21	21	2 3/8	24	1 3/8	24 3/4	17.25	18.19	18.18	x	18.20
	mm	711	533	533	60,3		34,9	629	438	462	462	x	462
20"	polegada	30 1/2	23	23 1/8	2 1/2	24	1 3/8	27	19.25	20.19	20.20	x	20.25
	mm	775	584	587	63,5		34,9	686	489	513	513	x	514
24"	polegada	36	27 1/4	27 5/8	2 3/4	24	1 5/8	32	23.25	24.19	24.25	x	24.25
	mm	914	692	702	69,8		41,3	813	590,5	614	616	x	616

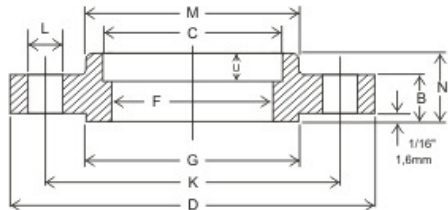

Flange de encaixe

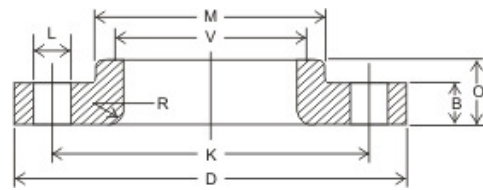

Flange solto

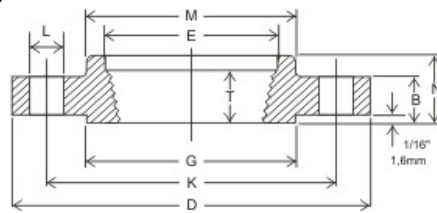

Flange roscado

Medidas diversas							Peso aprox. Pounds e quilos				Medidas em	Diâmetro nominal
A	H	N	O	T	U	R	Sobrepostos de encaixe, roscados	com pescoço	soltos	cegos		
0.84	2 1/16	7/8	7/8	5/8	3/8	1/8	2	2	2	2	polegada	1/2"
21,3	52,4	22,2	22,2	15,9	9,52	3,18	0,9	0,9	0,9	0,9	mm	
1,05	2 1/4	1	1	5/8	7/16	1/8	3	3	3	3	polegada	3/4"
26,7	57,2	25,4	25,4	15,9	11,1	3,18	1,4	1,4	1,4	1,4	mm	
1.32	2 7/16	1 1/16	1 1/16	11/16	1/2	1/8	3	4	3	3	polegada	1"
33,4	61,9	27,0	27,0	17,5	12,7	3,18	1,4	1,8	1,4	1,4	mm	
1.66	2 9/16	1 1/16	1 1/16	13/16	9/16	3/16	4	5	4	4	polegada	1 1/4"
42,2	65,1	27,0	27,0	20,6	14,3	4,76	1,8	2,3	1,8	1,8	mm	
1.90	2 11/16	1 3/16	1 3/16	7/8	5/8	1/4	6	7	6	6	polegada	1 1/2"
48,3	68,3	30,2	30,2	22,2	15,9	6,35	2,7	3,2	2,7	2,7	mm	
2.38	2 3/4	1 5/16	1 5/16	1 1/8	11/16	5/16	7	9	7	8	polegada	2"
60,3	69,8	33,3	33,3	28,6	17,5	7,94	3,2	4,1	3,2	3,6	mm	
2.88	3	1 1/2	1 1/2	1 1/4	3/4	5/16	10	12	10	12	polegada	2 1/2"
73,0	76,2	38,1	38,1	31,8	19,0	7,94	4,5	5,4	4,5	5,4	mm	
3.50	3 1/8	1 11/16	1 11/16	1 1/4	13/16	3/8	13	15	13	16	polegada	3"
88,9	79,4	42,9	42,9	31,8	20,6	9,52	5,9	6,8	5,9	7,3	mm	
4.00	3 3/16	1 3/4	1 3/4	1 7/16	7/8	3/8	17	18	17	21	polegada	3 1/2"
102	81,0	44,4	44,4	36,5	22,2	9,52	7,7	8,2	7,7	9,5	mm	
4.50	3 3/8	1 7/8	1 7/8	1 7/16	15/16	7/16	22	25	22	27	polegada	4"
114	85,7	47,6	47,6	36,5	23,8	11,1	10,0	11,3	10,0	12,2	mm	
5.56	3 7/8	2	2	1 11/16	x	7/16	28	32	28	35	polegada	5"
141	98,4	50,8	50,8	42,9	x	11,1	12,7	14,5	12,7	15,9	mm	
6.62	3 7/8	2 1/16	2 1/16	1 13/16	x	1/2	39	42	39	50	polegada	6"
168	98,4	52,4	52,4	46	x	12,7	17,7	19,0	17,7	22,7	mm	
8.62	4 3/8	2 7/16	2 7/16	2	x	1/2	58	67	58	81	polegada	8"
219	111	61,9	61,9	50,8	x	12,7	26,3	30,4	26,3	36,7	mm	
10.75	4 5/8	2 5/8	3 3/4	2 3/16	x	1/2	81	91	91	125	polegada	10"
273	117	66,7	95,2	55,6	x	12,7	36,7	41,3	41,3	56,7	mm	
12.75	5 1/8	2 7/8	4	2 3/8	x	1/2	115	140	140	185	polegada	12"
324	130	73	102	60,3	x	12,7	52,2	63,5	63,5	83,9	mm	
14.00	5 5/8	3	4 3/8	2 1/2	x	1/2	165	180	190	250	polegada	14"
356	143	76,2	111	63,5	x	12,7	74,8	81,6	86,2	113	mm	
16.00	5 3/4	3 1/4	4 3/4	2 11/16	x	1/2	190	250	250	295	polegada	16"
406	146	82,6	121	68,3	x	12,7	86,2	113	113	134	mm	
18.00	6 1/4	3 1/2	5 1/8	2 3/4	x	1/2	250	320	295	395	polegada	18"
457	159	88,9	130	69,8	x	12,7	113	145	134	179	mm	
20.00	6 3/8	3 3/4	5 1/2	2 7/8	x	1/2	315	400	370	505	polegada	20"
508	162	95,2	140	73,0	x	12,7	143	181	168	229	mm	
24.00	6 5/8	4 3/16	6	3 1/4	x	1/2	475	580	550	790	polegada	24"
610	168	106	152	82,6	x	12,7	215	263	249	358	mm	

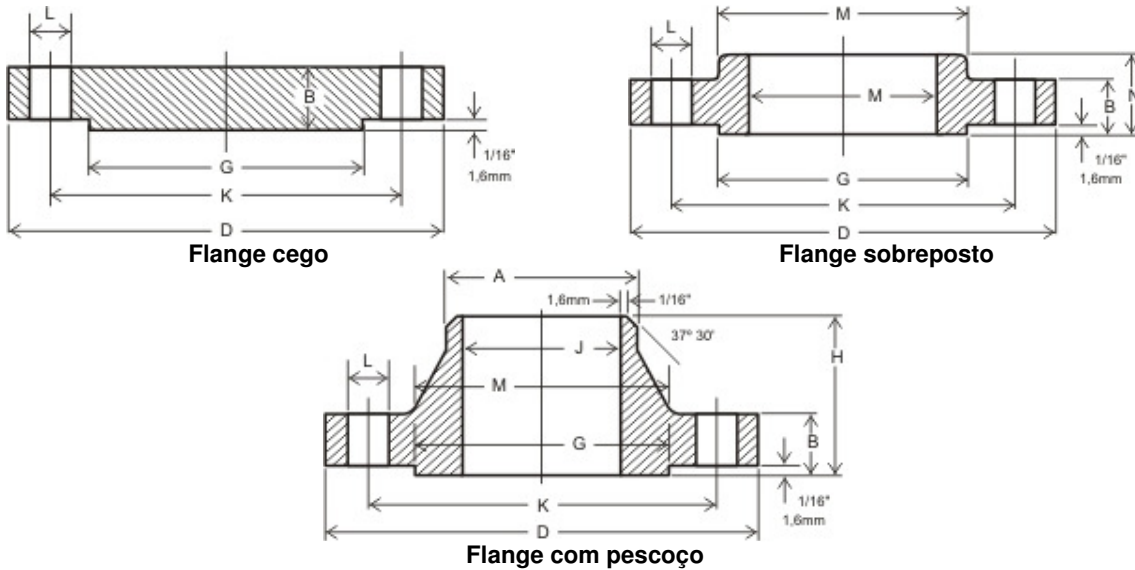

Diâmetro Nominal	Medida em	Medidas Comuns							Furos				
		D	G	M	B	Nº	L	K	J	E	C	F	V
1/2"	polegada	3 3/4	1 3/8	1 1/2	9/16	4	5/8	2 5/8	Especificações sob encomenda	0.93	0.88	x	0.9
	mm	95,2	34,9	38,1	14,3		15,9	66,7		23,6	22,3	x	22,9
3/4"	polegada	4 5/8	1 11/16	1 7/8	5/8	4	3/4	3 1/4		1.14	1.09	x	1.11
	mm	117,5	42,9	47,6	15,9		19,05	82,5		28,95	27,7	x	28,2
1"	polegada	4 7/8	2	2 1/8	11/16	4	3/4	3 1/2		1.41	1.38	x	1.38
	mm	123,8	50,8	54	17,5		19,05	88,9		35,8	35	x	35,1
1 1/4"	polegada	5 1/4	2 1/2	2 1/2	13/16	4	3/4	3 7/8		1.75	1.72	x	1.72
	mm	133,3	63,5	63,5	20,6		19,05	98,4		44,45	43,7	x	43,7
1 1/2"	polegada	6 1/8	2 7/8	2 3/4	7/8	4	7/8	4 1/2		1.99	1.97	x	1.97
	mm	155,6	73	69,8	22,2		22,2	114,0		50,5	50,3	x	50
2"	polegada	6 1/2	3 5/8	3 5/16	1	8	3/4	5		2.5	2.44	x	2.46
	mm	165	92	84,1	25,4		19,05	127		63,5	62	x	62,5
2 1/2"	polegada	7 1/2	4 1/8	3 15/16	1 1/8	8	7/8	5 7/8		3	2.94	x	2.97
	mm	190,5	104,8	100	28,6		22,2	149,2		76,2	74,7	x	75,4
3"	polegada	8 1/4	5	4 5/8	1 1/4	8	7/8	6 5/8		3.63	3.56	x	3.6
	mm	209,5	127	117,5	31,8		22,2	168,3		92,2	90,4	x	91,4
3 1/2"	polegada	9	5 1/2	5 1/4	1 3/8	8	1	7 1/4		4.13	4.06	x	4.1
	mm	228,6	139,7	133,3	34,9		25,4	184,1		104,9	103,1	x	104,1
4"	polegada	10	6 3/16	5 3/4	1 3/8	8	1	7 7/8		4.63	4.57	x	4.60
	mm	254	157	146	34,9		25,4	200		118	116	x	117
5"	polegada	11	7 5/16	7	1 1/2	8	1	9 1/4		5.69	5.66	x	5.69
	mm	279	186	178	38,1		25,4	235		145	144	x	145
6"	polegada	12 1/2	8 1/2	8 1/8	1 5/8	12	1	10 5/8		6.75	6.72	x	6.75
	mm	318	216	206	41,3		25,4	270		171	171	x	171
8"	polegada	15	10 5/8	10 1/4	1 7/8	12	1 1/8	13	8.75	8.72	x	8.75	
	mm	381	270	260	47,6		28,6	330	222	221	x	222	
10"	polegada	17 1/2	12 3/4	12 5/8	2 1/8	16	1 1/4	15 1/4	10.88	10.88	x	10.92	
	mm	444	324	321	54,0		31,8	387	276	276	x	277	
12"	polegada	20 1/2	15	14 3/4	2 1/4	16	1 3/8	17 3/4	12.94	12.88	x	12.92	
	mm	521	381	375	57,2		34,9	451	329	327	x	328	
14"	polegada	23	16 1/4	16 3/4	2 3/8	20	1 3/8	20 1/4	14.19	14.14	x	14.18	
	mm	584	413	425	60,3		34,9	514	360	359	x	360	
16"	polegada	25 1/2	18 1/2	19	2 1/2	20	1 1/2	22 1/2	16.19	16.16	x	16.19	
	mm	648	470	483	63,5		38,1	572	411	410	x	411	
18"	polegada	28	21	21	2 5/8	24	1 1/2	24 3/4	18.19	18.18	x	18.20	
	mm	711	533	533	66,7		38,1	629	462	462	x	462	
20"	polegada	30 1/2	23	23 1/8	2 3/4	24	1 5/8	27	20.19	20.20	x	20.25	
	mm	775	584	587	69,8		41,3	686	513	513	x	514	
24"	polegada	36	27 1/4	27 5/8	3	24	1 7/8	32	24.19	24.25	x	24.25	
	mm	914	692	702	76,2		47,6	813	614	616	x	616	

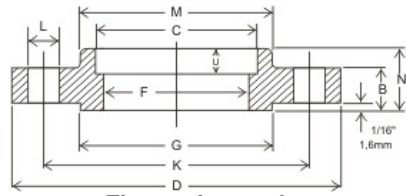

Flange de encaixe

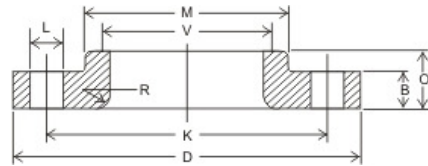

Flange solto

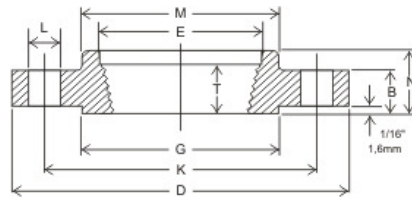

Flange roscado

Medidas diversas							Peso aprox. Pounds e quilos				Medidas em	Diâmetro nominal
A	H	N	O	T	U	R	Sobrepostos de encaixe, roscados	com pescoço	soltos	cegos		
0.84	2 1/16	7/8	7/8	5/8	x	1/8	2	2	2	2	polegada	1/2"
21,3	52,4	22,2	22,2	15,9	x	3,2	0,9	0,9	0,9	0,9	mm	
1.05	2 1/4	1	1	5/8	x	1/8	3	4	3	3	polegada	3/4"
26,7	57,1	25,4	25,4	15,9	x	3,2	1,4	1,8	1,4	1,4	mm	
1.32	2 7/16	1 1/16	1 1/16	11/16	x	1/8	4	4	4	4	polegada	1"
33,5	61,9	27	27	17,5	x	3,2	1,8	1,8	1,8	1,8	mm	
1.66	2 5/8	1 1/8	1 1/8	13/16	x	3/16	5	6	5	5	polegada	1 1/4"
42,2	66,7	28,6	28,6	20,6	x	4,8	2,3	2,7	2,3	2,3	mm	
1.9	2 3/4	1 1/4	1 1/4	7/8	x	1/4	7	8	7	8	polegada	1 1/2"
48,3	69,8	31,7	31,7	22,2	x	6,4	3,1	3,6	3,2	3,6	mm	
2.38	2 7/8	1 7/16	1 7/16	1 1/8	x	5/16	9	12	9	10	polegada	2"
60,45	73	36,5	36,5	28,6	x	7,9	4	5,4	4,1	4,5	mm	
2.88	3 1/8	1 5/8	1 5/8	1 1/4	x	5/16	13	18	12	15	polegada	2 1/2"
73,15	79,4	41,3	41,3	31,8	x	7,9	6	8,2	5,4	6,8	mm	
3.5	3 1/4	1 13/16	1 13/16	1 3/8	x	3/8	16	23	15	20	polegada	3"
88,9	82,5	46	46	34,9	x	9,5	7	10,4	6,8	9,1	mm	
4	3 3/8	1 15/16	1 15/16	1 9/16	x	3/8	21	26	20	29	polegada	3 1/2"
101,6	85,7	49,2	49,2	39,7	x	9,5	9,5	11,8	9,1	13,2	mm	
4.50	3 1/2	2	2	1 7/16	x	7/16	26	35	25	33	polegada	4"
114,0	88,9	50,8	50,8	36,5	x	11,1	11,8	16,0	11,3	15,0	mm	
5.56	4	2 1/8	2 1/8	1 11/16	x	7/16	31	43	29	44	polegada	5"
141,0	102	54,0	54	42,9	x	11,1	14,1	19,5	13,2	20,0	mm	
6.62	4 1/16	2 1/4	2 1/4	1 13/16	x	1/2	44	57	42	61	polegada	6"
168	103	57,2	57,2	46	x	12,7	20,0	26,0	19,1	27,7	mm	
8.62	4 5/8	2 11/16	2 11/16	2	x	1/2	67	89	64	100	polegada	8"
219	117	68,3	68,3	50,8	x	12,7	30,4	40,4	29,0	45,4	mm	
10.75	4 7/8	2 7/8	4	2 3/16	x	1/2	91	125	110	155	polegada	10"
273	124	73,0	102	55,6	x	12,7	41,3	56,7	49,9	70,3	mm	
12.75	5 3/8	3 1/8	4 1/4	2 3/8	x	1/2	130	175	150	225	polegada	12"
324	137	79,4	108	60,3	x	12,7	59,0	79,4	68,0	102	mm	
14.00	5 7/8	3 5/16	4 5/8	2 1/2	x	1/2	180	230	205	290	polegada	14"
356	149	84,1	117	63,5	x	12,7	81,6	104	93,0	132	mm	
16.00	6	3 11/16	5	2 11/16	x	1/2	235	295	260	370	polegada	16"
406	152	93,7	127	68,3	x	12,7	107	134	118	168	mm	
18.00	6 1/2	3 7/8	5 3/8	2 3/4	x	1/2	285	350	315	455	polegada	18"
457	165	98,4	137	69,8	x	12,7	129	159	143	206	mm	
20.00	6 5/8	4	5 3/4	2 7/8	x	1/2	345	425	385	585	polegada	20"
508	168	102	146	73,0	x	12,7	156	193	175	265	mm	
24.00	6 7/8	4 1/2	6 1/4	3 1/4	x	1/2	510	620	570	890	polegada	24"
610	175	114	159	82,6	x	12,7	231	281	259	404	mm	

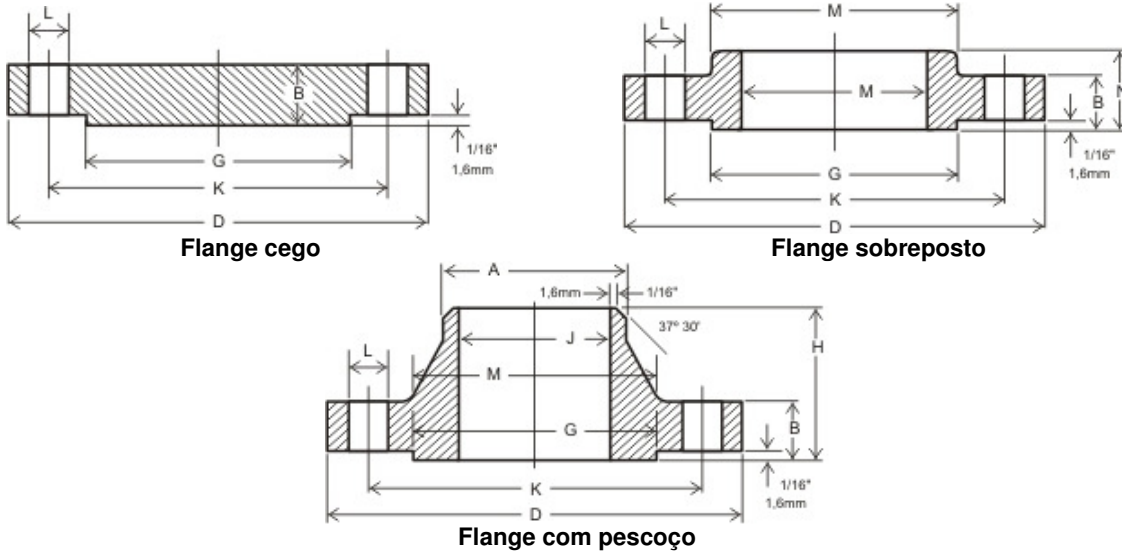

Diâmetro Nominal	Medida em	Medidas Comuns							Furos				
		D	G	M	B	Nº	L	K	J	E	C	F	V
1/2"	polegada	3 3/4	1 3/8	1 1/2	9/16	4	5/8	2 5/8	Especificações sob encomenda	0.93	0.88	0.62	0.90
	mm	95,2	34,9	38,1	14,3	4	15,9	66,7		23,6	22,4	15,75	22,9
3/4"	polegada	4 5/8	1 11/16	1 7/8	5/8	4	3/4	3 1/4		1.14	1.09	0.82	1.11
	mm	117	42,9	47,6	15,9	4	19,0	82,6		29,0	27,7	20,8	28,2
1"	polegada	4 7/8	2	2 1/8	11/16	4	3/4	3 1/2		1.41	1.36	1.05	1.38
	mm	124	50,8	54,0	17,5	4	19,0	88,9		35,8	34,5	26,7	35,1
1 1/4"	polegada	5 1/4	2 1/2	2 1/2	13/16	4	3/4	3 7/8		1.75	1.70	1.38	1.72
	mm	133	63,5	63,5	20,6	4	19,0	98,4		44,4	43,2	35,05	43,7
1 1/2"	polegada	6 1/8	2 7/8	2 3/4	7/8	4	7/8	4 1/2		1.99	1.95	1.61	1.97
	mm	156	73,0	69,8	22,2	4	22,2	114		50,5	49,5	40,9	50,0
2"	polegada	6 1/2	3 5/8	3 5/16	1	8	3/4	5		2.50	2.44	2.07	2.46
	mm	165	92,1	84,1	25,4	8	19,0	127		63,5	62,0	52,6	62,5
2 1/2"	polegada	7 1/2	4 1/8	3 15/16	1 1/8	8	7/8	5 7/8		3.00	2.94	2.47	2.97
	mm	190	105	100	28,6	8	22,2	149		76,2	74,7	62,7	75,4
3"	polegada	8 1/4	5	4 5/8	1 1/4	8	7/8	6 5/8		3.63	3.57	3.07	3.60
	mm	210	127	117	31,8	8	22,2	168		92,2	90,7	78	91,4
3 1/2"	polegada	9	5 1/2	5 1/4	1 3/8	8	1	7 1/4		4.13	4.07	3.55	4.10
	mm	229	140	133	34,9	8	25,4	184		105	103	90,2	104
4"	polegada	10 3/4	6 3/16	6	1 1/2	8	1	8 1/2		4.63	4.57	4.03	4.60
	mm	273	157	152	38,1	8	25,4	216		118	116	102,4	117
5"	polegada	13	7 5/16	7 7/16	1 3/4	8	1 1/8	10 1/2		5.69	.566	x	5.69
	mm	330	186	189	44,4	8	28,6	267		145	144	x	145
6"	polegada	14	8/12	8 3/4	1 7/8	12	1 1/8	11 1/2		6.75	6.72	x	6.75
	mm	356	216	222	47,6	12	28,6	292		171	171	x	171
8"	polegada	16 1/2	10 5/8	10 3/4	2 3/16	12	1 1/4	13 3/4	8.75	8.72	x	8.75	
	mm	419	270	273	55,6	12	31,8	349	222	221	x	222	
10"	polegada	20	12 3/4	13 1/2	2 1/2	16	1 3/8	17	10.88	10.88	x	10.92	
	mm	508	324	343	63,5	16	34,9	432	276	276	x	277	
12"	polegada	22	15	15 3/4	2 5/8	20	1 3/8	19 1/4	12.94	12.88	x	12.92	
	mm	559	381	400	66,7	20	34,9	489	329	327	x	328	
14"	polegada	23 3/4	16 1/4	17	2 3/4	20	1 1/2	20 3/4	14.19	14.14	x	14.18	
	mm	603	413	432	69,8	20	38,1	527	360	359	x	360	
16"	polegada	27	18 1/2	19 1/2	3	20	1 5/8	23 3/4	16.19	16.16	x	16.19	
	mm	686	470	495	76,2	20	41,3	603	411	410	x	411	
18"	polegada	29 1/4	21	21 1/2	3 1/4	20	1 3/4	25 3/4	18.19	18.18	x	18.20	
	mm	743	533	546	82,6	20	44,4	654	462	462	x	462	
20"	polegada	32	23	24	3 1/2	24	1 3/4	28 1/2	20.19	20.20	x	20.25	
	mm	813	584	610	88,9	24	44,4	724	513	513	x	514	
24"	polegada	37	27 1/4	28 1/4	4	24	2	33	24.19	24.25	x	24.25	
	mm	940	692	718	102	24	50,8	838	614	616	x	616	

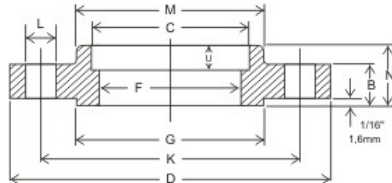

Flange de encaixe

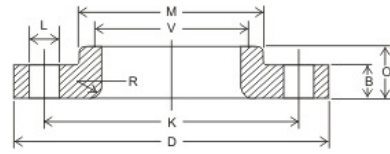

Flange solto

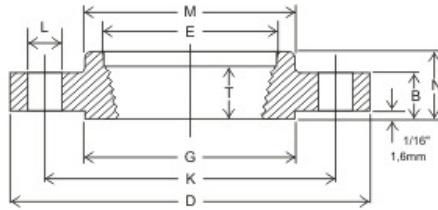

Flange roscado

Medidas diversas							Peso aprox. Pounds e quilos				Medidas em	Diâmetro Nominal
A	H	N	O	T	U	R	Sobrepostos de encaixe, roscados	com pescoço	soltos	cegos		
0.84	2 1/16	7/8	7/8	5/8	3/8	1/8	2	2	2	2	polegada	1/2"
21,3	52,4	22,2	22,2	15,9	9,52	3,18	0,9	0,9	0,9	0,9	mm	
1.05	2 1/4	1	1	5/8	7/16	1/8	3	4	3	3	polegada	3/4"
26,7	57,2	25,4	25,4	15,9	11,1	3,18	1,4	1,8	1,4	1,4	mm	
1.32	2 7/16	1 1/16	1 1/16	11/16	1/2	1/8	4	4	4	4	polegada	1"
33,4	61,9	27,0	27,0	17,5	12,7	3,18	1,8	1,8	1,8	1,8	mm	
1.66	2 5/8	1 1/8	1 1/8	13/16	9/16	3/16	5	6	5	5	polegada	1 1/4"
42,2	66,7	28,6	28,6	20,6	14,3	4,76	2,3	2,7	2,3	2,3	mm	
1.90	2 3/4	1 1/4	1 1/4	7/8	5/8	1/4	7	8	7	8	polegada	1 1/2"
48,3	69,8	31,8	31,8	22,2	15,9	6,35	3,2	3,6	3,2	3,6	mm	
2.38	2 7/8	1 7/16	1 7/16	1 1/8	11/16	5/16	9	12	9	10	polegada	2"
60,3	73,0	36,5	36,5	28,6	17,5	7,94	4,1	5,4	4,1	4,5	mm	
2.88	3 1/8	1 5/8	1 5/8	1 1/4	3/4	5/16	13	18	12	15	polegada	2 1/2"
73,0	79,4	41,3	41,3	31,8	19,0	7,94	5,9	8,2	5,4	6,8	mm	
3.50	3 1/4	1 13/16	1 13/16	1 3/8	13/16	3/8	16	23	15	20	polegada	3"
88,9	82,6	46	46	34,9	20,6	9,52	7,3	10,4	6,8	9,1	mm	
4.00	3 3/8	1 15/16	1 15/16	1 9/16	7/8	3/8	21	26	20	29	polegada	3 1/2"
102	85,7	49,2	49,2	39,7	22,2	9,52	9,5	11,8	9,1	13,2	mm	
4.50	4	2 1/8	2 1/8	1 5/8	15/16	7/16	37	42	36	41	polegada	4"
114	102	54,0	54,0	41,3	23,8	11,1	16,8	19,0	16,3	18,6	mm	
5.56	4 1/2	2 3/8	2 3/8	1 7/8	x	7/16	63	68	61	68	polegada	5"
141	114	60,3	60,3	47,6	x	11,1	28,6	31,0	27,7	30,8	mm	
6.62	4 5/8	2 5/8	2 5/8	2	x	1/2	80	81	78	86	polegada	6"
168	117	66,7	66,7	50,8	x	12,7	36,3	36,7	35,4	39,0	mm	
8.62	5 1/4	3	3	2 1/4	x	1/2	115	120	110	140	polegada	8"
219	133	76,2	76,2	57,2	x	12,7	52,2	54,4	49,9	63,5	mm	
10.75	6	3 3/8	4 3/8	2 9/16	x	1/2	170	190	170	230	polegada	10"
273	152	85,7	111	65,1	x	12,7	77,1	86,2	77,1	104	mm	
12.75	6 1/8	3 5/8	4 5/8	2 3/4	x	1/2	200	225	200	295	polegada	12"
324	156	92,1	117	69,8	x	12,7	90,7	102	90,7	134	mm	
14.00	6 1/2	3 11/16	5	2 7/8	x	1/2	230	280	250	355	polegada	14"
356	165	93,7	127	73	x	12,7	104	127	113	161	mm	
16.00	7	4 3/16	5 1/2	3 1/16	x	1/2	330	390	365	495	polegada	16"
406	178	106	140	77,8	x	12,7	150	177	166	225	mm	
18.00	7 1/4	4 5/8	6	3 1/8	x	1/2	400	475	435	630	polegada	18"
457	184	117	152	79,4	x	12,7	181	215	197	286	mm	
20.00	7 1/2	5	6 1/2	3 1/4	x	1/2	510	590	570	810	polegada	20"
508	190	127	165	82,6	x	12,7	231	268	259	367	mm	
24.00	8	5 1/2	7 1/4	3 5/8	x	1/2	730	830	810	1250	polegada	24"
610	203	140	184	92,1	x	12,7	331	376	367	567	mm	

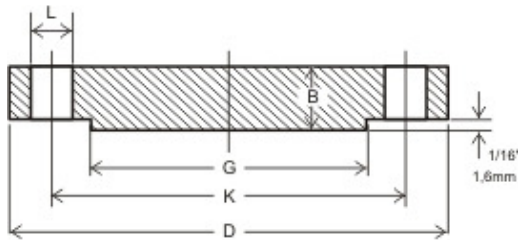

Flange cego

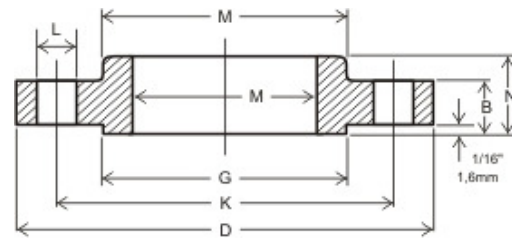

Flange sobreposto

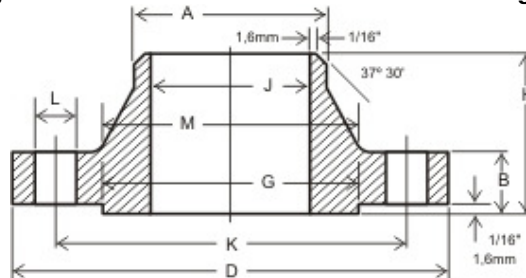

Flange com pescoço

Diâmetro Nominal	Medida em	Medidas Comuns							Furos				
		D	G	M	B	Nº	L	K	J	E	C	F	V
1/2"	polegada	4 3/4	1 3/8	1 1/2	7/8	4	7/8	3 1/4	Especificações sob encomenda	0.93	0.88	x	0.9
	mm	121	34,9	38,1	22,2		22,2	82,5		23,6	22,3	x	22,9
3/4"	polegada	5 1/8	1 11/16	1 3/4	1	4	7/8	3 1/2		1.14	1.09	x	11.1
	mm	130	42,9	44,4	25,4		22,2	88,9		28,95	27,7	x	28,2
1"	polegada	5 7/8	2	2 1/16	1 1/8	4	1	4		1.41	1.38	x	1.38
	mm	149	50,8	52,4	28,6		25,4	101,6		35,8	35	x	35,1
1 1/4"	polegada	6 1/4	2 1/2	2 1/2	1 1/8	4	1	4 3/8		1.75	1.72	x	1.72
	mm	159	63,5	63,5	28,6		25,4	111,1		44,45	43,7	x	43,7
1 1/2"	polegada	7	2 7/8	2 3/4	1 1/4	4	1 1/8	4 7/8		1.99	.197	x	1.97
	mm	178	73	69,8	31,8		28,6	123,8		50,5	50,3	x	50
2"	polegada	8 1/2	3 5/8	4 1/8	1 1/2	8	1	6 1/2		2.5	2.44	x	2.46
	mm	216	92,1	104,8	38,1		25,4	165,1		63,5	62	x	62,5
2 1/2"	polegada	9 5/8	4 1/8	4 7/8	1 5/8	8	1 1/8	7 1/2		3	2.94	x	2.97
	mm	244	104,8	123,8	41,3		28,6	190		76,2	74,7	x	75,4
3"	polegada	9 1/2	5	5	1 1/2	8	1	7 1/2	3.63	3.57	x	3.60	
	mm	241	127	127	38,1		25,4	190	92,2	90,7	x	91,4	
3 1/2"	polegada	x	x	x	x	x	x	x	x	x	x	x	
	mm	x	x	x	x		x	x	x	x	x	x	x
4"	polegada	11 1/2	6 3/16	6 1/4	1 3/4	8	1 1/4	9 1/4	4.63	4.57	x	4.60	
	mm	292	157	159	44,4		31,8	235	118	116	x	117	
5"	polegada	13 3/4	7 5/16	7 1/2	2	8	1 3/8	11	5.69	5.66	x	5.69	
	mm	349	186	190	50,8		34,9	279	145	144	x	145	
6"	polegada	15	8 1/2	9 1/4	2 3/16	12	1 1/4	12 1/2	6.75	6.72	x	6.75	
	mm	381	216	235	55,6		31,8	318	171	171	x	171	
8"	polegada	18 1/2	10 5/8	11 3/4	2 1/2	12	1 1/2	15 1/2	8.75	8.72	x	8.75	
	mm	470	270	298	63,5		38,1	394	222	221	x	222	
10"	polegada	21 1/2	12 3/4	14 1/2	2 3/4	16	1 1/2	18 1/2	10.88	10.88	x	10.92	
	mm	546	324	368	69,8		38,1	470	276	276	x	277	
12"	polegada	24	15	16 1/2	3 1/8	20	1 1/2	21	12.94	12.88	x	12.92	
	mm	610	381	419	79,4		38,1	533	329	327	x	328	
14"	polegada	25 1/4	16 1/4	17 3/4	3 3/8	20	1 5/8	22	14.19	14.14	x	14.18	
	mm	641	413	451	85,7		41,3	559	360	359	x	360	
16"	polegada	27 3/4	18 1/2	20	3 1/2	20	1 3/4	24 1/4	16.19	16.16	x	16.19	
	mm	705	470	508	88,9		44,4	616	411	410	x	411	
18"	polegada	31	21	22 1/4	4	20	2	27	18.19	18.18	x	18.20	
	mm	787	533	565	102		50,8	686	462	462	x	462	
20"	polegada	33 3/4	23	24 1/2	4 1/4	20	2 1/8	29 1/2	20.19	20.20	x	20.25	
	mm	857	584	622	108		54	749	513	513	x	514	
24"	polegada	41	27 1/4	29 1/2	5 1/2	20	2 5/8	35 1/2	24.19	24.25	x	24.25	
	mm	1041	692	749	140		66,7	902	614	616	x	616	

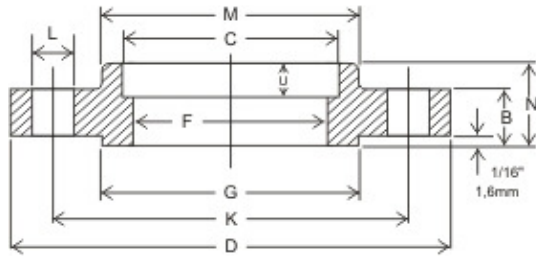

Flange de encaixe

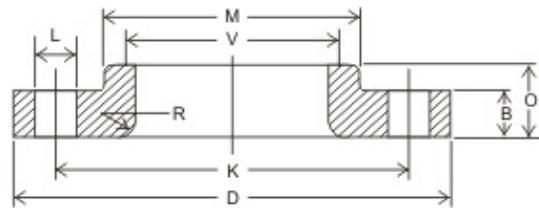

Flange solto

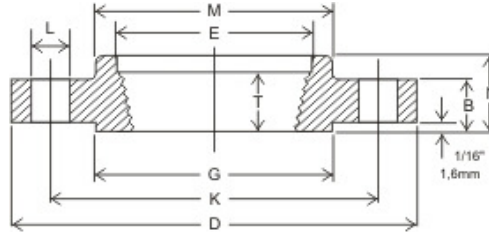

Flange roscado

Medidas diversas							Peso aprox. Pounds e quilos				Medidas em	Diâmetro nominal
A	H	N	O	T	U	R	Sobrepostos de encaixe, roscados	com pescoço	soltos	cegos		
0.84	2 3/8	1 1/4	1 1/4	7/8	x	1/8	4	5	4	4	polegada	1/2"
21,3	60,3	31,7	31,7	22,2	x	3,2	1,8	2,3	1,8	1,8	mm	
1,05	2 3/4	1 3/8	1 3/8	1	x	1/8	5	6	5	6	polegada	3/4"
26,7	69,8	34,9	34,9	25,4	x	3,2	2,3	2,7	2,3	2,7	mm	
1,32	2 7/8	1 5/8	1 5/8	1 1/8	x	1/8	8	9	8	8	polegada	1"
33,5	73	41,3	41,3	28,6	x	3,2	3,6	4,1	3,6	3,6	mm	
1.66	2.7/8	1 5/8	1 5/8	1 3/16	x	3/16	9	10	9	9	polegada	1 1/4"
42,2	73	41,3	41,3	30,2	x	4,8	4,1	4,5	4,1	4,1	mm	
1.9	3 1/4	1 3/4	1 3/4	1 1/4	x	1/4	12	13	12	13	polegada	1 1/2"
48,3	82,5	44,4	44,4	31,8	x	6,4	5,4	5,9	5,4	5,9	mm	
2.38	4	2 1/4	2 1/4	1 1/2	x	5/16	25	25	25	25	polegada	2"
60,45	102	57,1	57,1	38,1	x	7,9	11,3	11,3	11,3	11,3	mm	
2,88	4 1/8	2 1/2	2 1/2	1 7/8	x	5/16	36	36	35	35	polegada	2 1/2"
73,15	105	63,5	63,5	47,6	x	7,9	16,3	16,3	16	15,9	mm	
3.50	4	2 1/8	2 1/8	1 5/8	x	3/8	26	31	25	29	polegada	3"
88,9	102	54,0	54,0	41,3	x	9,52	11,8	14,0	11,3	13,2	mm	
x	x	x	x	x	x	x	x	x	x	x	polegada	3 1/2"
x	x	x	x	x	x	x	x	x	x	x	mm	
4,50	4 1/2	2 3/4	2 3/4	1 7/8	x	7/16	53	51	51	54	polegada	4"
114	114	69,8	69,8	47,6	x	11,1	24,0	23,0	23,1	24,5	mm	
5.56	5	3 1/8	3 1/8	2 1/8	x	7/16	83	86	81	87	polegada	5"
141	127	79,4	79,4	54,0	x	11,1	37,6	39,0	36,7	39,5	mm	
6.62	5 1/2	3 3/8	3 3/8	2 1/4	x	1/2	110	110	105	115	polegada	6"
168	140	85,7	85,7	57,2	x	12,7	49,9	50,0	47,6	52,2	mm	
8.62	6 3/8	4	4 1/2	2 1/2	x	1/2	170	175	190	200	polegada	8"
219	162	102	114	63,5	x	12,7	77,1	79,4	86,2	90,7	mm	
10.75	7 1/4	4 1/4	5	2 13/16	x	1/2	245	260	275	290	polegada	10"
273	184	108	127	71,4	x	12,7	111	118	125	132	mm	
12.75	7 7/8	4 5/8	5 5/8	3	x	1/2	325	325	370	415	polegada	12"
324	200	117	143	76,2	x	12,7	147	147	168	188	mm	
14.00	8 3/8	5 1/8	6 1/8	3 1/4	x	1/2	400	400	415	520	polegada	14"
356	213	130	156	82,6	x	12,7	181	181	188	236	mm	
16.00	8 1/2	5 1/4	6 1/2	3 3/8	x	1/2	425	495	465	600	polegada	16"
406	216	133	165	85,7	x	12,7	193	225	211	272	mm	
18.00	9	6	7 1/2	3 1/2	x	1/2	600	680	650	850	polegada	18"
457	229	152	190	88,9	x	12,7	272	308	295	386	mm	
20.00	9 3/4	6 1/4	8 1/4	3 5/8	x	1/2	730	830	810	1075	polegada	20"
508	248	159	210	92,1	x	12,7	331	376	367	488	mm	
24.00	11 1/2	8	10 1/2	4	x	1/2	1400	1500	1550	2025	polegada	24"
610	292	203	267	102	x	12,7	635	680	703	918	mm	

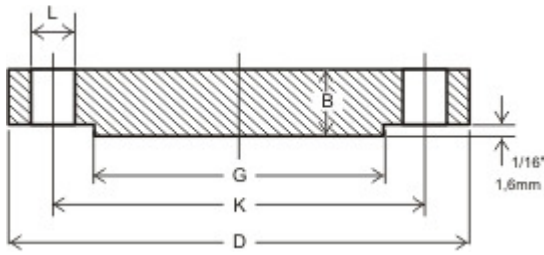

Flange cego

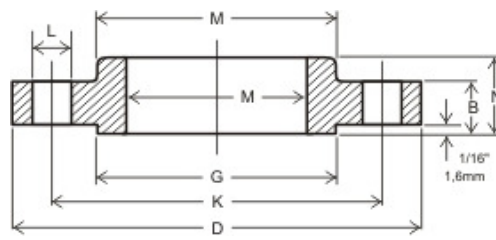

Flange sobreposto

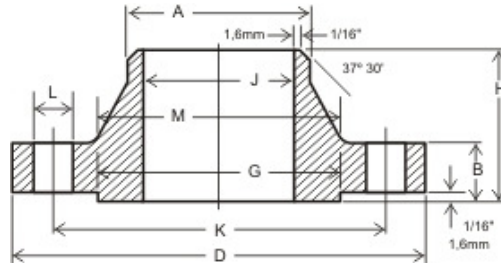

Flange com pescoço

Diâmetro Nominal	Medida em	Medidas Comuns							Furos				
		D	G	M	B	Nº	L	K	J	E	C	F	V
1/2"	polegada	4 3/4	1 3/8	1 1/2	7/8	4	7/8	3/14	Especificações sob encomenda	0.93	0.88	Especificações sob encomenda	0.90
	mm	121	34,9	38,1	22,2	4	22,2	82,6		23,6	22,4		22,9
3/4"	polegada	5 1/8	1 11/16	1 3/4	1	4	7/8	3 1/2		1.14	1.09		1.11
	mm	130	42,9	44,4	25,4	4	22,2	88,9		29,0	27,7		28,2
1"	polegada	5 7/8	2	2 1/16	1 1/8	4	1	4		1.41	1.36		1.38
	mm	149	50,8	52,4	28,6	4	25,4	102		35,8	34,5		35,1
1 1/4"	polegada	6 1/4	2 1/2	2 1/2	1 1/8	4	1	4 3/8		1.75	1.70		1.72
	mm	159	63,5	63,5	28,6	4	25,4	111		44,4	43,2		43,7
1 1/2"	polegada	7	2 7/8	2 3/4	1 1/4	4	1 1/8	4 7/8		1.99	1.95		1.97
	mm	178	73	69,8	31,8	4	28,6	124		50,5	49,5		50,0
2"	polegada	8 1/2	3 5/8	4 1/8	1 1/2	8	1	6 1/2		2.50	2.44		2.46
	mm	216	92,1	105	38,1	8	25,4	165		63,5	62,0		62,5
2 1/2"	polegada	9 5/8	4 1/8	4 7/8	1 5/8	8	1 1/8	7 1/2		3.00	2.94		2.97
	mm	244	105	124	41,3	8	28,6	190		76,2	74,7		75,4
3"	polegada	10 1/2	5	5 1/4	1 7/8	8	1 1/4	8		3.63	3.56		3.60
	mm	267	127	133	47,6	8	31,8	203		92,2	90,4		91,4
3 1/2"	polegada	x	x	x	x	x	x	x		x	x		x
	mm	x	x	x	x	x	x	x		x	x		x
4"	polegada	12 1/4	6 3/16	6 3/8	2 1/8	8	1 3/8	9 1/2		4.63	4.56		4.60
	mm	311	157	162	54,0	8	34,9	241		118	115,8		117
5"	polegada	14 3/4	7 5/16	7 3/4	2 7/8	8	1 5/8	11 1/2		5.69	5.66		5.69
	mm	375	186	197	73,0	8	41,3	292		145	143,8		145
6"	polegada	15 1/2	8 1/2	9	3 1/4	12	1 1/2	12 1/2		6.75	6.72		6.75
	mm	394	216	229	82,6	12	38,1	318		171	170,7		171
8"	polegada	19	10 5/8	11 1/2	3 5/8	12	1 3/4	15 1/2	8.75	8.72	8.75		
	mm	483	270	292	92,1	12	44,5	394	222	221,5	222		
10"	polegada	23	12 3/4	14 1/2	4 1/4	12	2	19	10.88	10.88	10.92		
	mm	584	324	368	108	12	50,8	483	276	276,3	277		
12"	polegada	26 1/2	15	17 3/4	4 7/8	16	2 1/8	22 1/2	12.94	12.88	12.92		
	mm	673	381	451	124	16	54,0	572	329	327,1	328		
14"	polegada	29 1/2	16 1/4	19 1/2	5 1/4	16	2 3/8	25	x	x	14.18		
	mm	749	413	495	133	16	60,3	635	x	x	360		
16"	polegada	32 1/2	18 1/2	21 3/4	5 3/4	16	2 5/8	27 3/4	x	x	16.19		
	mm	826	470	552	146	16	66,7	705	x	x	411		
18"	polegada	36	21	23 1/2	6 3/8	16	2 7/8	30 1/2	x	x	18.20		
	mm	914	533	597	162	16	73,0	775	x	x	462		
20"	polegada	38 3/4	23	25 1/4	7	16	3 1/8	32 3/4	x	x	20.25		
	mm	984	584	641	178	16	79,4	832	x	x	514		
24"	polegada	46	27 1/4	30	8	16	3 5/8	39	x	x	24.25		
	mm	1168	692	762	203	16	92,1	991	x	x	616		

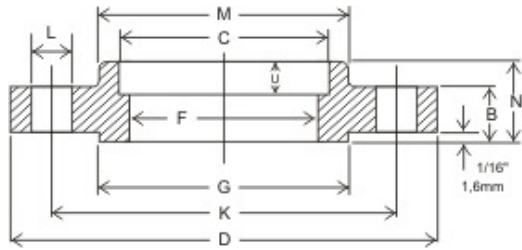

Flange de encaixe

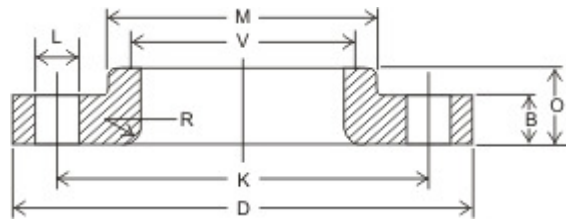

Flange solto

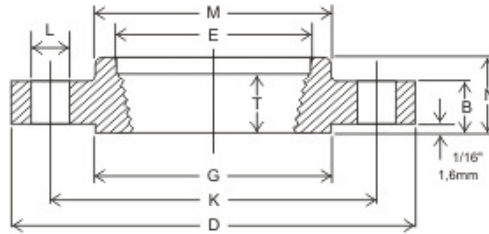

Flange roscado

Medidas diversas							Peso aprox. Pounds e quilos				Medidas em	Diâmetro nominal
A	H	N	O	T	U	R	Sobrepostos de encaixe, roscados	com pescoço	soltos	cegos		
0.84	2 3/8	1 1/4	1 1/4	7/8	3/8	1/8	4	5	4	4	pol./Inch.	1/2"
21,3	60,3	31,8	31,8	22,2	9,52	3,18	1,8	2,3	1,8	1,8	mm	
1.05	2 3/4	1 3/8	1 3/8	1	7/16	1/8	5	6	5	6	pol./Inch.	3/4"
26,7	69,8	34,9	34,9	24,5	11,1	3,18	2,3	2,7	2,3	2,7	mm	
1.32	2 7/8	1 5/8	1 5/8	1 1/8	1/2	1/8	8	9	8	8	pol./Inch.	1"
33,4	73,0	41,3	41,3	28,6	12,7	3,18	3,6	4,1	3,6	3,6	mm	
1.66	2.7/8	1.5/8	1.5/8	1.3/16	9/19	3/16	9	10	9	9	pol./Inch.	1 1/4"
42,2	73,0	41,3	41,3	30,2	14,3	4,76	4,1	4,5	4,1	4,1	mm	
1.90	3.1/4	1.3/4	1.3/4	1.1/4	5/8	1/4	12	13	12	13	pol./Inch.	1 1/2"
48,3	82,6	44,4	44,4	31,8	15,9	6,35	5,4	5,9	5,4	5,9	mm	
2.38	4	2 1/4	2 1/4	1 1/2	11/16	5/16	25	25	25	25	pol./Inch.	2"
60,3	102	57,2	57,2	38,1	17,5	7,94	11,3	11,3	11,3	11,3	mm	
2.88	4 1/8	2 1/2	2 1/2	1 7/8	3/4	5/16	36	36	35	35	pol./Inch.	2 1/2"
73,0	105	63,5	63,5	47,6	19,0	7,94	16,3	16,3	16,0	15,9	mm	
3.50	4 5/8	2 7/8	2 7/8	2	x	3/8	48	48	47	48	pol./Inch.	3"
88,9	117	73	73,0	50,8	x	9,52	21,8	21,8	21,3	21,8	mm	
x	x	x	x	x	x	x	x	x	x	x	pol./Inch.	3 1/2"
x	x	x	x	x	x	x	x	x	x	x	mm	
4.50	4 7/8	3 9/16	3 9/16	2 1/4	x	7/16	73	73	75	73	pol./Inch.	4"
114	124	90,5	90,5	57,2	x	11,1	33,1	33,0	34,0	33,1	mm	
5.56	6 1/8	4 1/8	4 1/8	2 1/2	x	7/16	130	130	140	140	pol./Inch.	5"
141	156	105	105	63,5	x	11,1	59	59,0	63,5	63,5	mm	
6.62	6 3/4	4 11/16	4 11/16	2 3/4	x	1/2	165	165	170	160	pol./Inch.	6"
168	171	119	119	69,8	x	12,7	74,8	75,0	77,1	72,6	mm	
8.62	8 3/8	5 5/8	5 5/8	3	x	1/2	260	275	285	300	pol./Inch.	8"
219	213	144	143	76,2	x	12,7	118	125	129	136	mm	
10.75	10	6 1/4	7	3 5/16	x	1/2	435	455	485	510	pol./Inch.	10"
273	254	159	178	84,1	x	12,7	197	206	220	231	mm	
12.75	11 1/8	7 1/8	8 5/8	3 5/8	x	1/2	580	690	630	690	pol./Inch.	12"
324	283	181	219	92,1	x	12,7	263	313	286	313	mm	
14.00	11 3/4	x	9 1/2	x	x	1/2	x	940	890	975	pol./Inch.	14"
356	298	x	241	x	x	12,7	x	426	404	442	mm	
16.00	12 1/4	x	10 1/4	x	x	1/2	x	1250	1150	1300	pol./Inch.	16"
406	311	x	260	x	x	12,7	x	567	522	590	mm	
18.00	12 7/8	x	10 7/8	x	x	1/2	x	1625	1475	1750	pol./Inch.	18"
457	327	x	276	x	x	12,7	x	737	669	794	mm	
20.00	14	x	11 1/2	x	x	1/2	x	2050	1775	2225	pol./Inch.	20"
508	356	x	292	x	x	12,7	x	930	805	1010	mm	
24.00	16	x	13	x	x	1/2	x	3325	2825	3625	pol./Inch.	24"
610	406	x	330	x	x	12,7	x	1510	1326	1644	mm	