



ACCURATE
LOCK & HARDWARE
AMERICAN CRAFTED SINCE 1972

6500 SERIES SCREEN/INTERIOR MORTISE LOCKS

6500 SERIES SCREEN/INTERIOR MORTISE LOCKS

TECHNICAL DETAILS

- Made completely out of brass (non-ferrous) and stainless steel (non-corrosive)
- For use in doors with narrow stiles (narrow backsets starting at 1 ½")
- Available with rabbeted fronts and strikes
- Standard and custom finishes available

BACKSETS: 1 ½", 1 ¾", 2"

For door stiles 2 11/16" wide and up.

CASE: Stainless steel (½" thick)

LATCH BOLT: Brass or stainless steel. 3/8" throw

DEADBOLT: Brass or stainless steel. 7/16" throw

HUBS: Available in different sizes to be compatible with various trims

THUMB TURN HUB: 3/16" (5mm) on the diamond

DUST BOX: Brass, stainless steel, or US10B

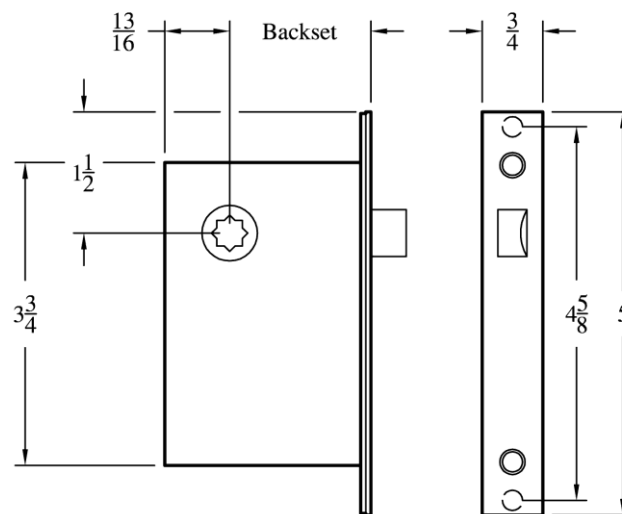

6525 Passage Latch Dimensions

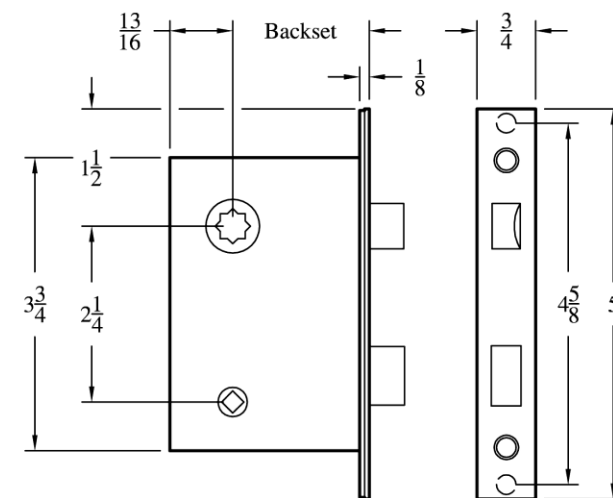

6539 Privacy Lock Dimensions

6500-9500 TRIM OPTIONS

6T TRADITIONAL ESCUTCHEON

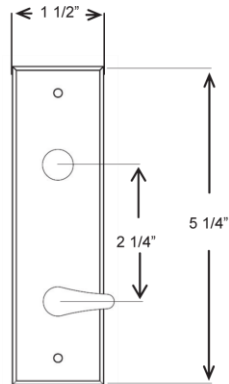

6O OVALO ESCUTCHEON

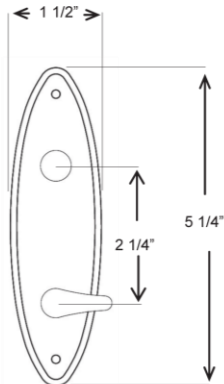

6R ROSES

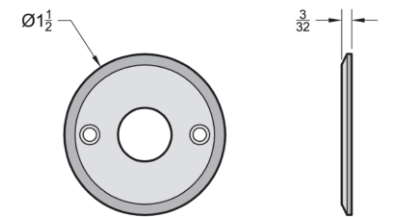

6RS

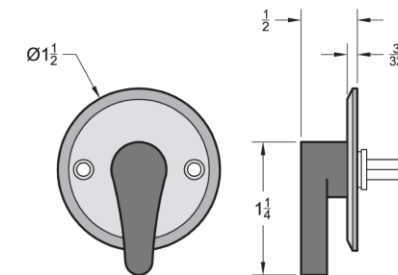

6RS-T

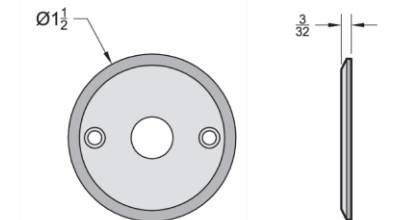

6RS-E

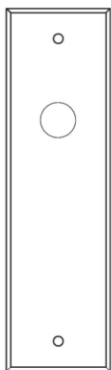

6T-O

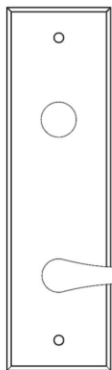

6T-T

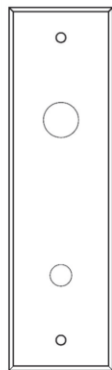

6T-E

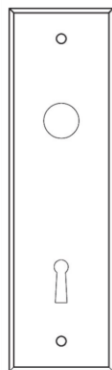

9T-K



6O-O



6O-T



6O-E



9O-K

LEVER AND KNOB OPTIONS

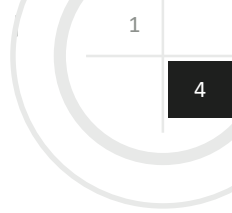

YORK LEVER



STAMFORD LEVER



REDONDO KNOB



COLONIAL KNOB

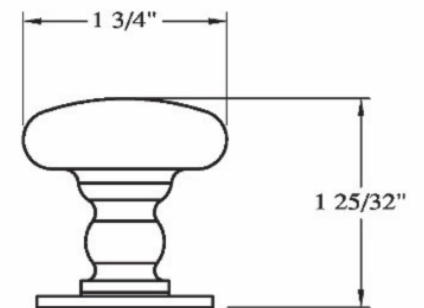
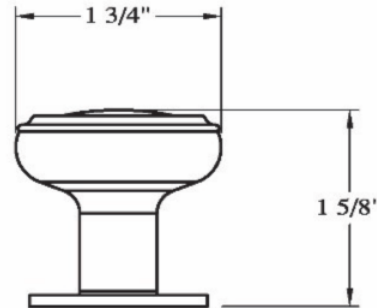
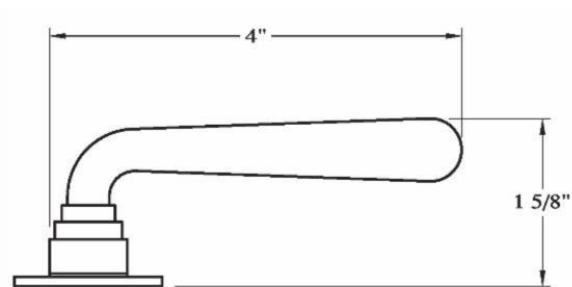
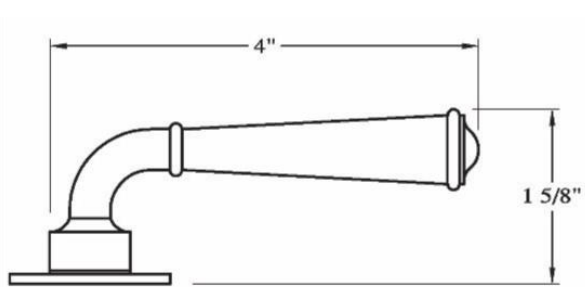

HOW TO SPECIFY

HANDING

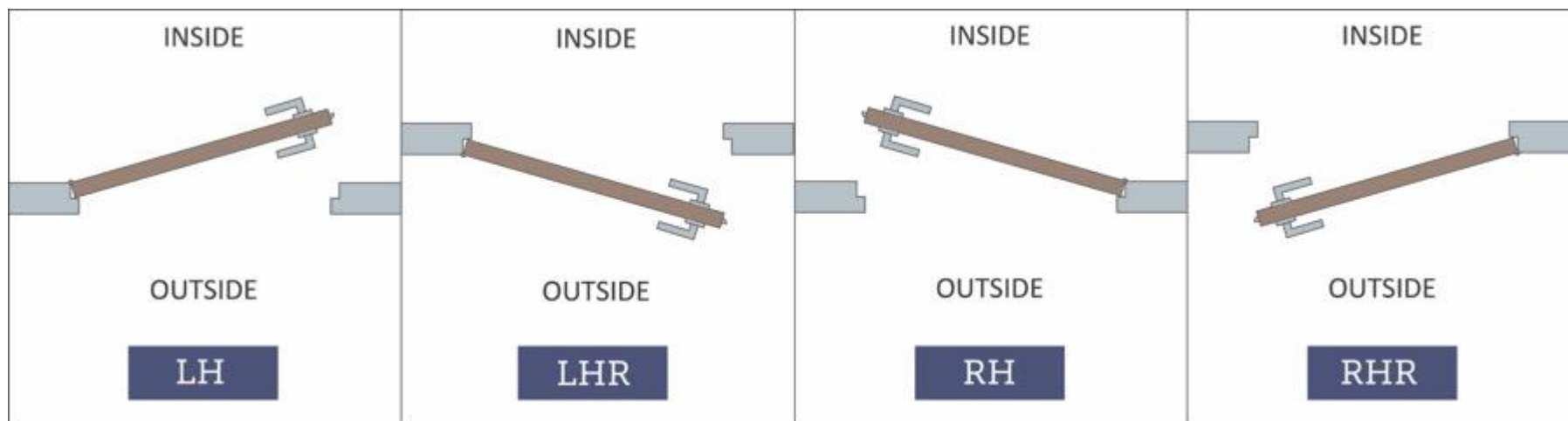

FINISHES

GROUP 1: US4, US4NL, US32D*, US26D

GROUP 2: US3, US3NL, US26, US32*, US9*, US10*, US10B, US14, US15, US19

GROUP 3: BN, BB, TN, TB, DURO, ESN, US15A, US5

* Trim options (including Accurate levers) may not be available in US32D, US32, US9, or US10 finish. Please call for assistance.

To view example of finishes visit: [Accurate Finishes](#)



HOW TO SPECIFY

FUNCTION.BACKSET.TRIM.FINISH.HAND.DOORTHICKNESS

Functions

See available functions (pg. 2)

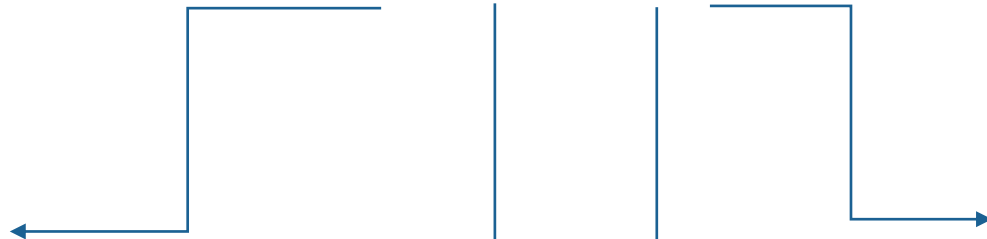

Finishes

See available finishes pg.7

Backsets
1 1/2", 1 3/4",
2"

Trim
Accurate Trim or Other
Manufacturers' Sectional (rose)
Trim (specify hub size or brand)*
Configurations:
• LxL, KxK, KxL, TPxK, TPxL,
TPxTP

EXAMPLES

Passage Latch | Other Manufacturers' Trim

E.g.: 6525.2.LxL.8mm.US32.RH.134

**ACCURATE LOCK & HARDWARE
MANUFACTURERS OF CUSTOM LOCKS
AND ARCHITECTURAL HARDWARE**

1 Annie Place | Stamford, CT 06902

P: 203.348.8865

F: 203.348.5234

E: sales@accuratelockandhardware.com

www.accuratelockandhardware.com



AMERICAN CRAFTED
— SINCE 1972 —