

www.Jedspeds.co.uk

Roanoke Kit

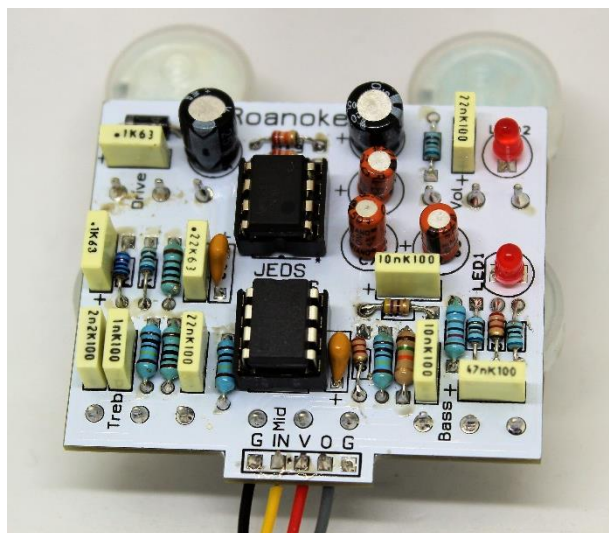

Please read the guide in full before starting your build. If it is blatantly obvious you haven't read it and contact us for help then don't be surprised if we tell you to read the guide again... harsh I know.

Parts List.

R1	1M	R16	22K	C13	2U2	DRIVE	100KB
R2	1M	R17	22K	C14	22N	VOL	100KA
R3	1K			C15	100N	BASS	25KB
R4	1K	C1	22N	C16	100U	MID	25KB
R5	10K	C2	1N	C17	100U	TREB	100KB
R6	1M	C3	100P				
R7	470R	C4	220N	IC1	TL072		
R8	2K2	C5	100N	IC2	LM833		
R9	6K8	C6	100P				
R10	6K8	C7	2U2	D1	4001		
R11	68K	C8	2U2	LED1	3MM RED		
R12	2K2	C9	47N	LED2	3MM RED		
R13	15K	C10	10N				
R14	6K8	C11	2N2				
R15	6K8	C12	10N				

Kit Specific Notes

Nothing too tricky here, excellent pedal and a straight forward build.

General Build Instruction

The first thing you must do is identify your parts from the pack. As a rule, I build from small to big – therefore step one will be to identify the resistors and any diodes inside your kit.

Each kit has a parts list at the top of the guide. So as an example, if R1 is listed as a 1M resistor then you dig out a 1M from the pack and place it on the PCB in the R1 spot. It's your call if you put one in and solder or put a few in or even put them all in and solder. I'll let you decide.

The front of the PCB is the side with the white writing on (the silkscreen)

You then need to follow the same process for all the other parts included. Working in height order mount the rest of the parts to the PCB ensuring that you solder them in place well as you go.

Some parts are quite heat sensitive so you must be careful when soldering them. Diodes, chips and transistors mainly. They can easily burn out by overheating.

I would then add the offboard wires, starting with nice long ones leaving them to be trimmed to length later. Finally, I add the pots either mounting them to the board or wiring them into place.

Useful links

[Resistor calculator](#)

Pots

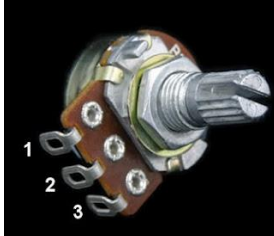

Pin Numbers for the pots. Snap the little metal tag off before trying to put it through the holes in the box.

Some of our PCBs are now designed to use right angled mount pcb potentiometers. They mount from the rear as indicated by the pcb. We will provide right angled pots as stocked, this means that you may receive a "normal" pot on occasion and you will have to wire it. It's not that inconvenient now is it.

The other options for pots are that they are wired into place or the PCB hangs from them.

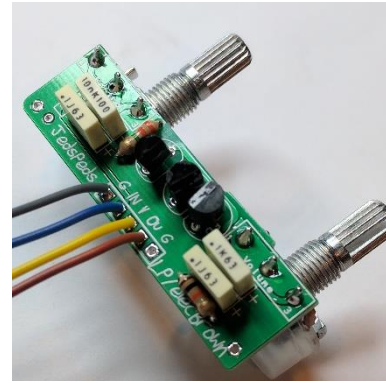
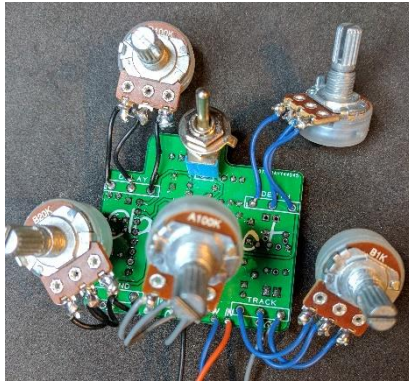
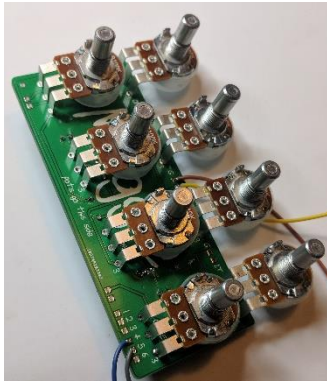

Hooking up the Jacks

Our kits come with mono jacks. They have two connections, a positive or the tip connection. And a negative, or sleeve connection.

The tip connections will connect to the 3PDT as shown later in the guide unless there are instructions otherwise.

The sleeve connections are ground points, all grounds throughout a build must connect. The Jack socket will then connect to the enclosure and ground the case.

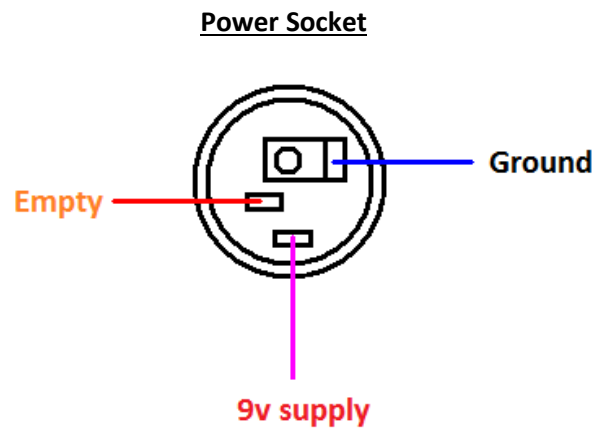

TEST THE BOARD

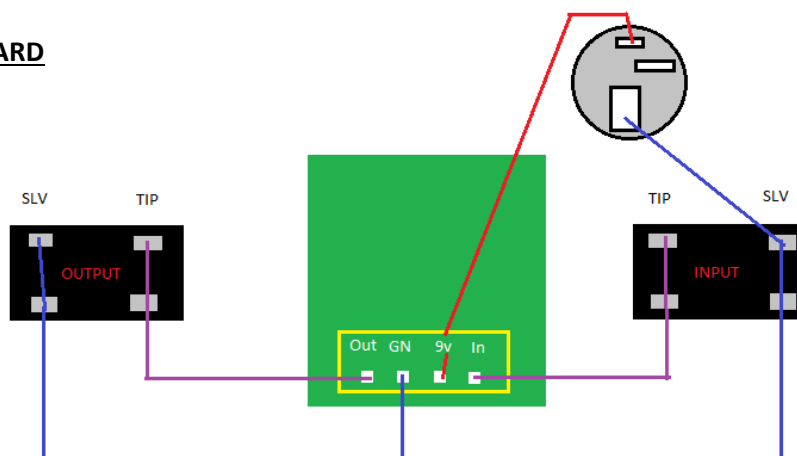

When you get to the stage with the board and pots wired you need to test the board before you add the foot switch. Firstly, don't put it in the box – I see people building inside a tiny enclosure and I wonder why. Some PCB's are tight enough as it is without reducing your workspace to 6cm wide!

Connect Input pad to TIP of Input jack. Same with output. Then connect the power to the 9v pad. Connect all grounds together (board, jack sleeves and 9v) If your board is working at this point then you can start work on the switch! If not...get double checking! If you email asking me why your pedal isn't working the first thing I will ask is... "did it work without the switch?", so make sure you follow this step.

If your PCB is working you are ready to connect the board to the footswitch! Follow the next stages meticulously and all being well by the end of it you will have a lovely finished pedal!

The next step involves undoing the tip wires from the PCB as they will now move to the 3PDT.

If its not working at this stage then you need to find out why. Do not continue beyond this point until you get it working. Adding a footswitch will not magically make a circuit work.

Troubleshooting is a necessary evil at times.

The Footswitch.

Have a look at the footswitch. It has 9 pins. The orientation of the switch is crucial. If you do it wrong your switch will not work, you might ruin it and you will certainly have to un do it.

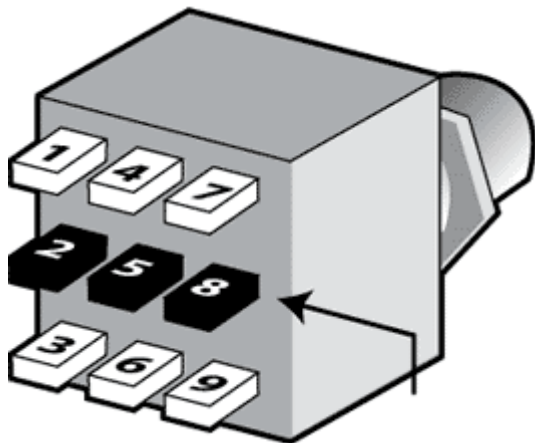

The pins on the switch must run left to right like this, so the top row of pins would be 1, 4, and 7.

If you put it in with 1, 2, and 3 across the top row you are wrong.

To help you a little further with ensuring the orientation of your switch is correct. To compare both 3PDT images you would have this...

- Pin 1 – Empty
- Pin 2 – Ground
- Pin 3 – LED
- Pin 4 – Pin 7
- Pin 5 – Input Jack tip

Please make sure you get the switch the correct way!

- Pin 6 – PCB Input
- Pin 7 – Pin 4
- Pin 8 – Output Jack Tip
- Pin 9 – PCB Output

There are loads of ways to wire up the footswitch. I use this one, I always have. Its never let me down and is easy to hook up.

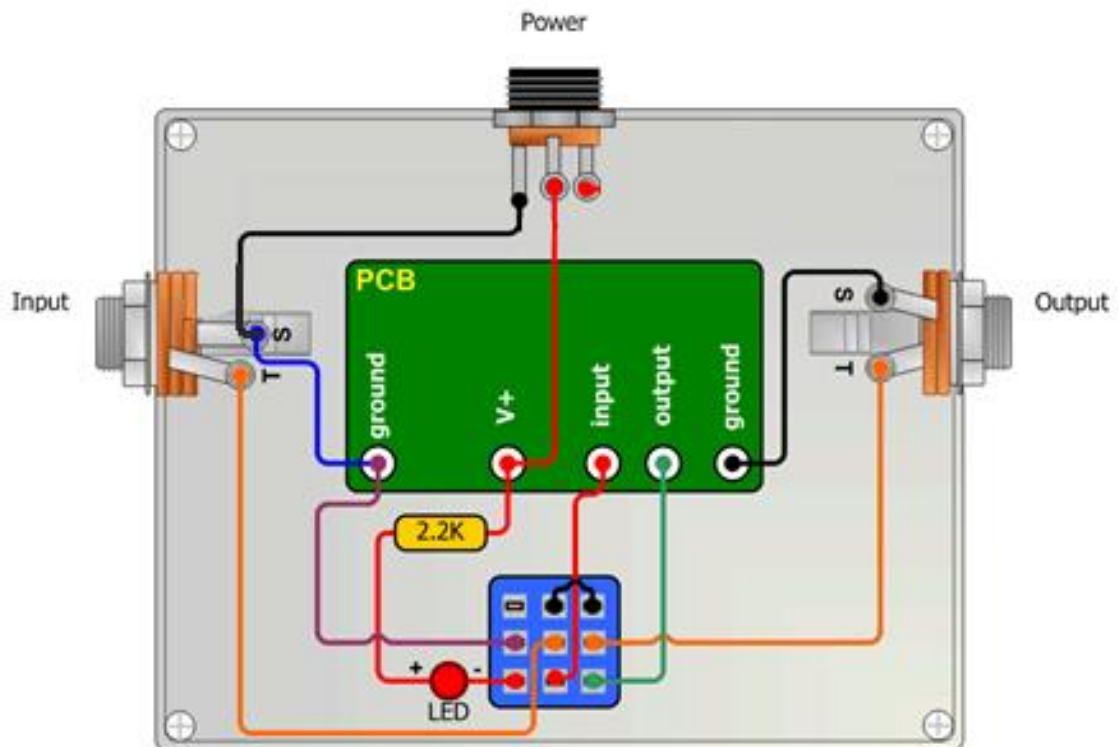

The 2k2 resistor can be any value up to 4k7. You will have a spare in the kit to use.

Good luck and happy soldering!

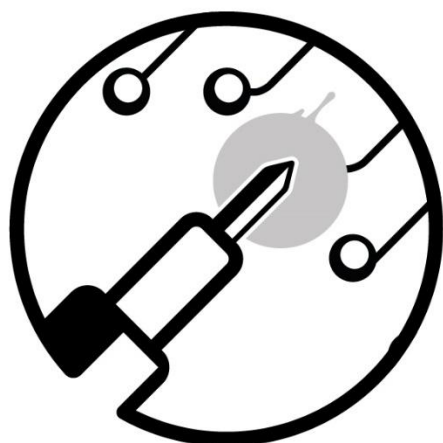

JEDS PEDS

PCB Design Notes



1. All PCBs are designed by ourselves, and tested before sale.
2. Box caps are shown with a + polarity mark on the silk screen, this is irrelevant as the box caps are non-polarised so can go either way.
3. Spare ground points may be provided on the PCB layout, use them if you wish but there is no requirement to.