

GN9000D SERIES

INSTRUCTION BOOK // PARTS CATALOGUE



AUTOMATIC OVERLOCK MACHINE



TYPICAL

1. SPECIAL PARTS

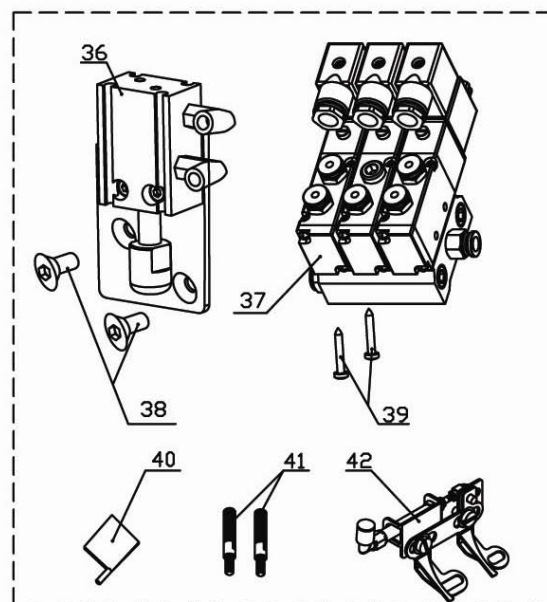
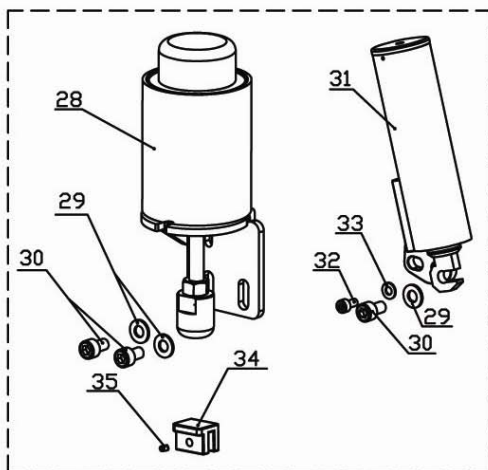
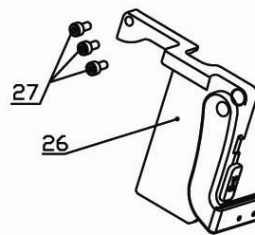
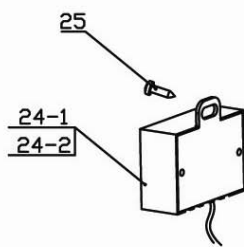
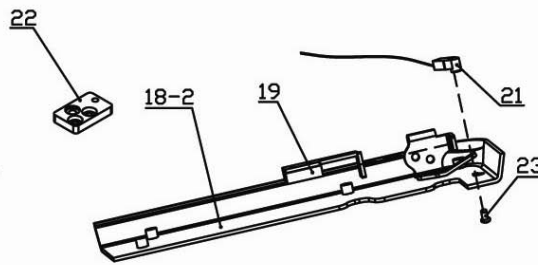
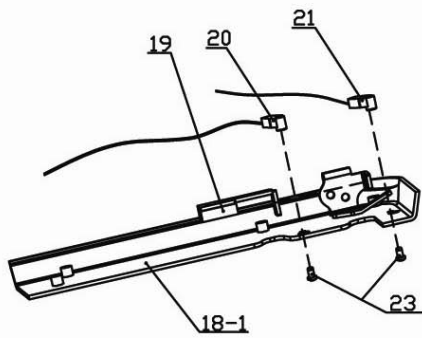
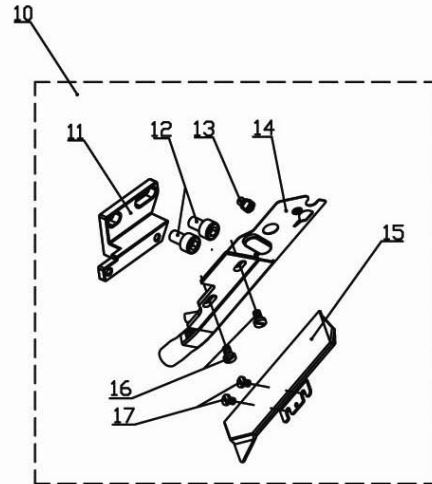
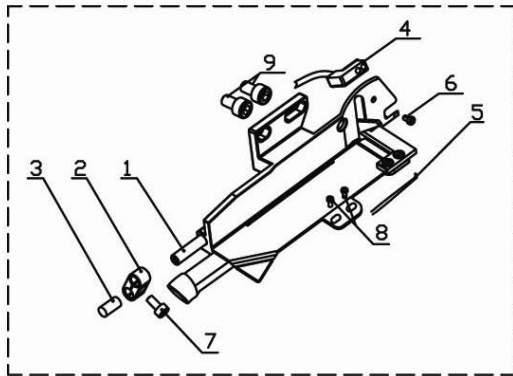

1. SPECIAL PARTS

No	Ref.No.	Description	3/4H/5/5H		
			E3	Q3	Q3/S
1	210H10006	Wire cutter assy (Chopper type)	1	1	
2	210H10005	Slotted locking block	1	1	
3	210H10004	Pin	1	1	
4	210H10010	Post emission sensor	1	1	
5	210H10009	Receiving behind sensor	1	1	
6	S150216015	Screw M3 x 8 GB/T 818 - 85	1	1	
7	S150209044	Screw M4 x 8 GB/T 70.1 - 2000	1	1	
8	S150201018	Screw M4 x 8 GB/T 65 - 85	2	2	
9	S150209030	Screw M6 x 12 GB/T 70.1 - 2000	2	2	
10	210K10003	Wire cutter assy (Side suction)			1
11	210K10003 - 1	Fixed block			1
12	S150211019	Ocket head screw M6 x 10 GB/T 70.1 - 2000			2
13	210K10003 - 2	Moving knife slider assy			1
14	210K10003 - 3	Tool post knife holder assy			1
15	210K10003 - 3	Footwall			1
16	210K10003 - 4	Screw M4.5 x 8			2
17	210K10003 - 5	Screw M4 x 5.5			2
18 - 1	210H00002	Sewing table (Chopper type)	1	1	
18 - 2	210K00001	Sewing table (Side suction)			1
19	210H10012	Protection switch	1	1	1
20	210H10007	Receiving sensor of front shear	1	1	
21	210H10008	Self starting sensor	1	1	1
22	210H00003	Needle plate bracket	1	1	1
23	210H10008 - 1	Screw M2.5 x 5 GB/T 819.1 - 2000	2	2	1
24 - 1	210H10011	Wire box assy (Chopper type)	1	1	
24 - 2	210K10005	Wire box assy (Side suction)			1
25	S150221016	Tapping screw ST4.8 x 16 GB/T 845 - 85	1	1	1
26	210H10013	Manual switch assy	1	1	1
27	S150209049	Socket head cap screw M4 x 14 GB/T 70.1 - 2000	3	3	3
28	210H10001	Presser foot electromagnet assy	1		
29	S150605003	Plain washer 6 GB/T 95 - 1985	3	2	
30	S150209056	Socket head cap screw M6 x 16 GB/T 70.1 - 2000	3	2	
31	210H10003	Shear line electromagnet assy	1		
32	S150209049	Socket head cap screw M4 x 14 GB/T 70.1 - 2000	1		
33	S150605001	Plain washer 4 GB/T 95 - 1985	1		
34	210H10002	Padding block	1	1	1
35	S150212006	Inner six angle screw M5 x 6 GB/T 77 - 2000	1	1	1
36	210K10001	Presser foot cylinder assy			1
37	210K10004	Solenoid valve assy			1
38	S150211011	Inner six angle screw M6 x 12 GB/T 70.3 - 2000		2	2
39	S150221018	Tapping screw ST2.9 x 30 GB/T 845 - 85		2	2
40	210K10006	Auxiliary blowing device			1
41	210K10007	Screw			2
42	210K10008	Loose line device			1

Other spare parts are same as the parts of 9000D series

2. SPECIAL PARTS

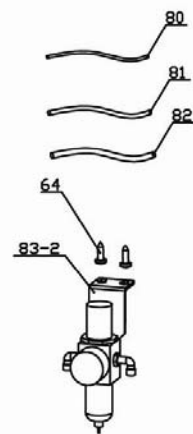
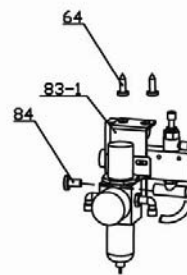
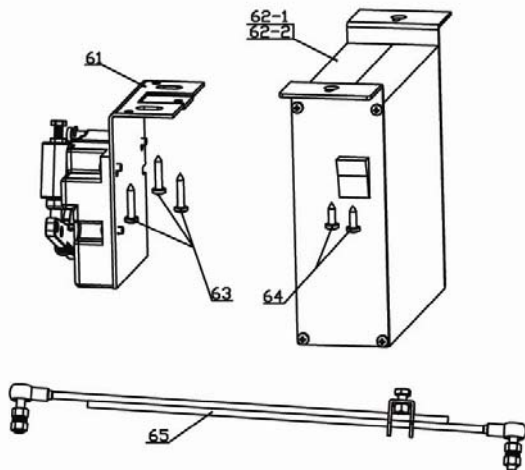
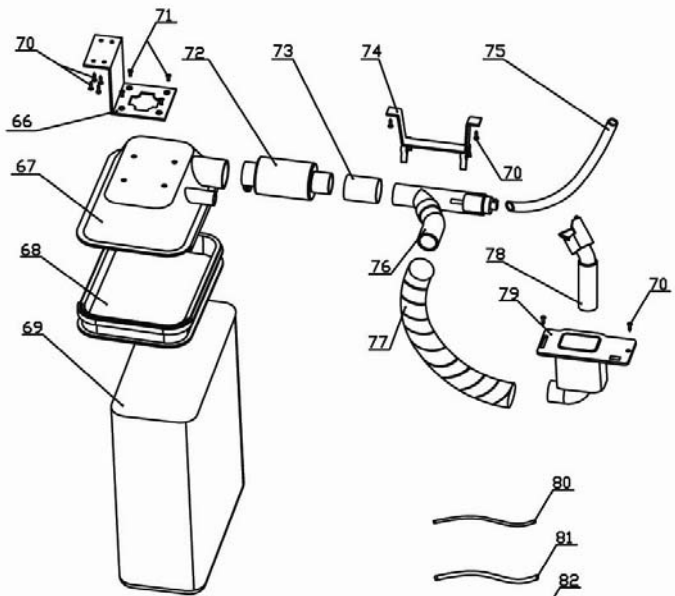
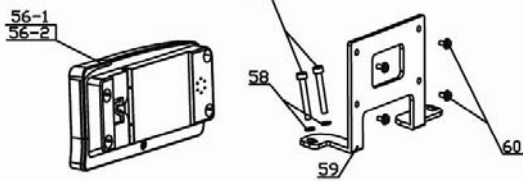
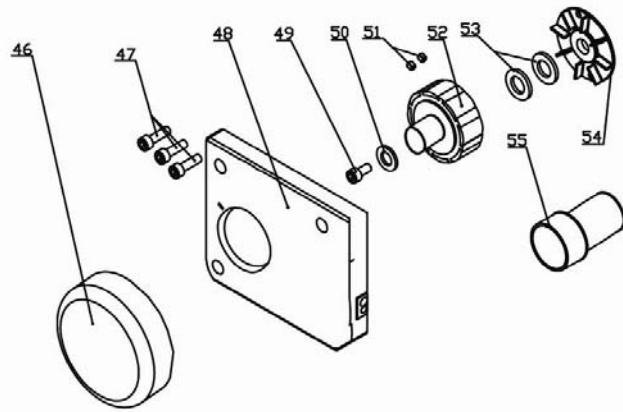
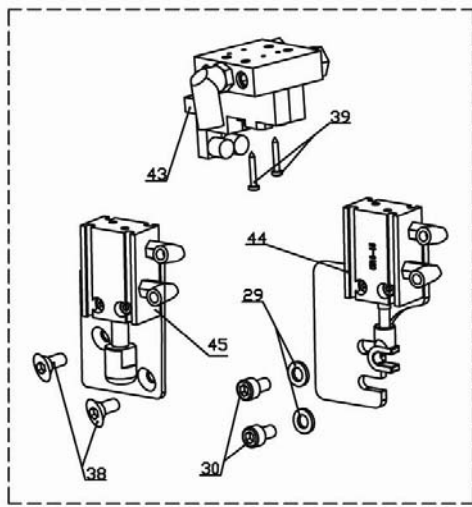

2. SPECIAL PARTS

No	Ref.No.	Description	3/4H/5/5H		
			E3	Q3	Q3/S
43	210M10004	Solenoid valve assy		1	
44	210M10003	Shear line cylinder assy		1	
45	210M10001	Presser foot cylinder assy		1	
46	210H10014	Hand wheel	1	1	1
47	S150209055	Socket head cap screw M6 x 12 GB/T 70.1 - 2000	3	3	3
48	210H10015	Motor stator	1	1	1
49	210H10016	Screw	1	1	1
50	210H10017	Washer	1	1	1
51	S150212006	Socket head cap screw M5 x 6 GB/T 77 - 2000	2	2	2
52	210H10018	Motor rotor	1	1	1
53	210H10019	Washer	4	4	4
54	210H10020	Blades	1	1	1
55	210H10021	Motor mounting tool	1	1	1
56 - 1	210H20002	Display (Chopper type)	1	1	
56 - 2	210K20001	Display (Side suction)			1
57	S150209051	Socket head cap screw M4 x 25 GB/T 70.1 - 2000	2	2	2
58	S150605001	Plain washer 4 GB/T 95 - 1985	2	2	2
59	210H20003	Display stand	1	1	1
60	276110002	Screw M3 x 10	4	4	4
61	210H20001	Governor	1	1	1
62 - 1	210H20005	Control cabinet (Chopper type)	1	1	
62 - 2	210K20002	Control cabinet (Side suction)			1
63	S150221017	Tapping screw ST4.8 x 25 GB/T 845 - 85	3	3	3
64	S150221016	Tapping screw ST4.8 x 16 GB/T 845 - 85	4	4	4
65	210H20004	Pull rod	1	1	1
66	210H30001	Bag hanger	1	1	1
67	210H30002	Bag base	1	1	1
68	210H30003	Bag cover	1	1	1
69	210H30004	Bag	1	1	1
70	S150221019	Tapping screw ST4.8 x 20 GB/T 846 - 85	8	8	8
71	S150211019	Socket head cap screw M6 x 10 GB/T 70.1 - 2000	4	4	4
72	210H30005	Noise suppressor	1	1	1
73	210H30006	Connecting tube	1	1	1
74	210H30007	Y type tube table hanger	1	1	1
75	210H30008	Hose tube	1	1	1
76	210H30012	Y type tube	1	1	1
77	210H30011	Threaded pipe	1	1	1
78	210H30009	Sewing table suction tube	1	1	1
79	210H30010	Waste bucket	1	1	1
80	276300002	Trachea 4	2	2	
81	276300003	Trachea 6	1	1	
82	276300004	Trachea 8	1	1	
83 - 1	210H30013	Filter regulator valve assy	1	1	
83 - 2	210K30001	Filter regulator valve			1
84	276300017	Spigot 8	1	1	

Other spare parts are same as the parts of 9000D series

Operation Panel Instruction

3.1 Appearance and key

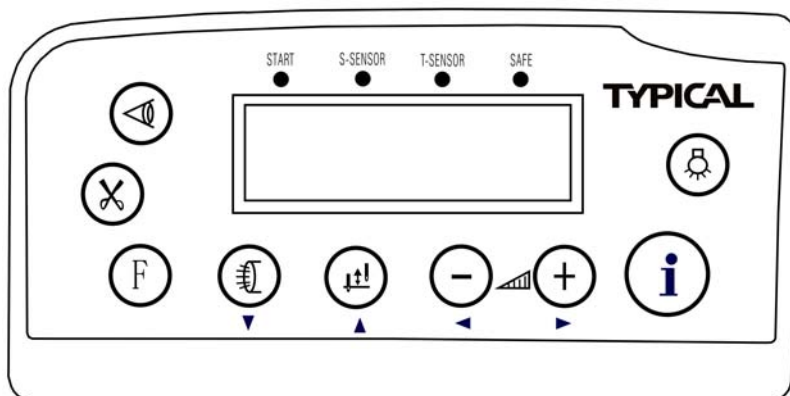





Fig 3.1 The appearance of operation panel

"SAFE" indicator light (Yellow): remind users when the safety switch is off.

Operate/ malfunction indicator light (green/red):when the electric motor of the sewing machine runs , the green light is on; when the system fails , the red light is on.

No.	Appearance	Description
1		Main menu key: return the top main interface, also can worked when pressed with other keys at the same time.
2		Automatic mode selection key: in the case of all sensor open,continuous press can choose automatic pedal or automatic sensor control mode.
3		Sensor function select key: open or close the sensor function。 Sensor shut down and turn into the manual mode; It be can choose semi-automatic or automatic mode after sensor open. Additionally, the starting sensor delay parameters can be modified.
4		Trimming selection key: select the trimming mode when sewing. continuous press are optional front trimming, back trimming, front and back trimming ,and trimming the closure of four modes; additionally, the opened shear line delay pin number modified can be modified.
5		Suck function selection keys: select the suction mode when sewing. Continuous press front trimming suction, back trimming suction, front and back suction and suction closure four kinds of modes; additionally, the open time parameters of front trimming suction can be modified. (down key: according to the reminder on the screen, select down, used to modify index number)
6		Needle stop position selection key: select the needle position when stop. Continuous press up stop position, down stop position and close the needle stop position in turn. (Up key: according to the reminder on the screen, select up, used to modify index number)

7		Deceleration key: decrease the highest speed when sewing. (Left key: according to the reminder on the screen, select left, used to modify parameter value)
8		Acceleration key: increase the highest speed when sewing. (Right key: according to the reminder on the screen, select right, used to modify parameter value)
9		Head lamp key : modify the height of head lamp. Continuous press the key and grade 0~3 can be selected, grade 0 is close.

3.2 Main interface

The control panel is correctly inserted into the corresponding electrical control box and make sure the power is open safely. After two second of starting up, the lcd will display the main interface (Fig 3.2).

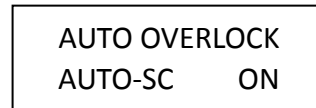

Fig 3.2 System main interface

3.3 Working mode setting

Automatic sewing machine system according to the requirements can work in manual mode, semi-automatic mode, automatic pedal control mode and automatic sensor control mode. Wherein, the manual mode controls the sewing machine operation entirely by foot pedals. In this case, sensor is closed, and detection and automatic trimming function is invalid. Semi-automatic mode controls sewing machine operation by the sensors combined with foot pedal. In this case, sensor function open, but starting sensor is closed, and foot pedals as well as trimming are valid. Automatic pedal control mode controls foot automatically by the starting sensor. Foot pedals starts the sewing process. Automatic sensor control mode is entirely controlled sewing machine automatically by the sensor. In this case, foot pedals is invalid.

Sewing mode	Sensor function	Starting sensor	Automatic mode selection
Semi - manual	Off	Off	Invalid
Semi - automatic	On	Off	Semi - automatic
Automatic pedal control	On	On	Automatic pedal control
Automatic sensor control	On	On	Automatic sensor control

For example: manual mode main interface when the sensor is closed (Fig 3.3)

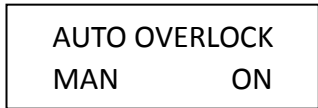



Fig 3.3 Manual mode system main interface

Press  key at main interface, in this case, the current status of sensor is displayed on the screen (Fig 3.4).

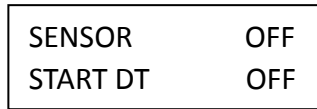

Fig 3.4 Sensor close

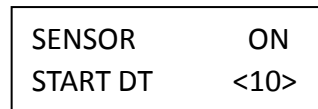





Fig 3.5 Sensor open

Press  key again , sensor switch on (Fig 3.5), in this case, Press  and  key to adjust the delay time parameter of the starting sensor. After finishing the setting, press  key to return main interface.

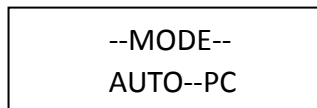

Fig 3.6 Automatic pedal control

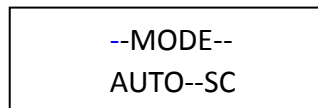





Fig 3.7 Automatic sensor control

After returning to main interface , in the case of sensor function open but starting sensor do not close, press  key can select Automatic pedal control mode (Fig 3.6) or automatic sensor control mode (Fig 3.7). After finishing the setting, press  key to return main interface.

3.4 Trimming function setting

Press  key on main interface, the trimming function setting will display on the screen. Then press  key, trimming function will switch between front trimming (fig 3.8), back trimming (fig 3.9), front and back trimming (fig 3.10) and close trimming (fig 3.11).

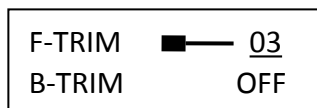

Fig 3.8 Front trimming

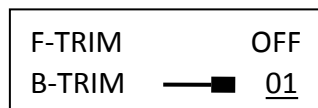

Fig 3.9 Back trimming



Fig 3.10 front and back trimming

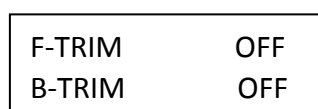







Fig 3.11 close trimming

When front trimming or back trimming mode opens, the parameters of trimming delay needle quantity display on the screen. Press 、 key trimming delay needle quantity. When front trimming and back trimming mode open at the same time, press  or  key to switch modify parameters of front or back trimming delay needle quantity. After finishing trimming function setting, press  key to return main interface.

3.5 Suck function setting



Press  key on the main interface, suck function setting will display on the screen (Fig 3.12). Then press  key, suck function will switch between close trimming suction (Fig 3.12), front trimming suction (Fig 3.13), back trimming suction (Fig 3.14), and front and back suction (Fig 3.15).



Fig 3.12 Close trimming suction



Fig 3.13 Front trimming suction



Fig 3.14 Back trimming suction

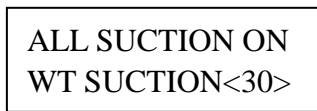







Fig 3.15 Front and back trimming suction

When the front trimming or front and back trimming suction function is open, the front trimming suction open time parameter will display on the screen. Press  ,  key can modify this parameter to adjust suction open time. After finishing suck function setting, press  key to return main interface.

3.6 Needle stop position setting

Press  key on the main interface, needle stops position during operation setting will display on the screen. Then press  key, needle stop position during operation will switch between down stop (Fig 3.16), up stop (Fig 3.17) and closed (Fig 3.18).

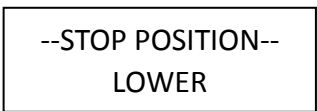

Fig. 3.16 Needle stop down

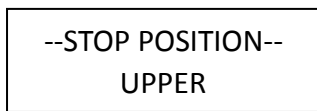

Fig 3.17 Needle stop up

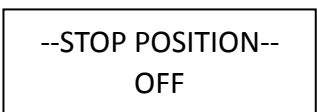







Fig 3.18 Close needle stop position

After finishing needle stop position setting, press  key to return main interface.

3.7 The highest speed setting

Press  or  key, the highest running speed of sewing machine will display on the screen (Fig. 3.19). Then press  or  key can modify the highest running speed. The highest running speed increases/decreases 50 rpm when press the keys every time. After finishing the highest running speed setting, press  key to return main interface.

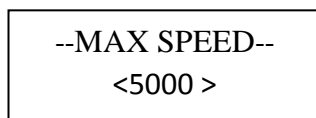



Fig 3.19 The highest speed

3.8 Advanced function

3.8.1 Chinese - English switch

Press  for 3 seconds on main interface can complete Chinese-English switch of the operation panel.

3.8.2 The sensor parameters setting











Press  +  key simultaneously on the main interface, and then enter into the interface of the sensor parameters inquire setting. Under this interface, the signal and emission intensity of three sensors can be viewed and set. Press  or  can switch page between starting sensor, s-sensor and t-sensor. The data of the first row in every page is the detection signal value of the current sensor. The data of the second row is variable emission intensity, and press  or  can modify this parameter. After finishing this setting, press  key to return main interface. Close starting sensor operation: In Fig 3.20 interface, press  key to modify sensor emission intensity till displaying “ OFF ” . After finishing this setting, press  key to return main interface. Open starting sensor operation: When the emission intensity of starting sensor is “ OFF ” , press  key to change the emission intensity of starting sensor to number. After finishing this setting, press  key to return main interface.



Fig 3.20 The signal and threshold of starting sensor



Fig 3.21 The signal and threshold of s - sensor

T-SENSOR 0200
EMISSION INTENSITY <050>

Fig 3.22 The signal and threshold of t - sensor

3.8.3 Ordinary parameter Settings

Press **i** + **↑↓** key simultaneously on the main interface, and then enter into the password interface of ordinary parameter settings (Fig 3.23).

PASSWORD
< 7777 >

Fig 3.23 Parameter password

The modification of the password can be achieved by using **-** or **+**. Press **i** key, if the password is right then enter into the page of parameter setting (Fig 3.24); if the password is wrong then return main interface.

P-01
< 0400 >

Fig 3.24 parameter setting

In the page of parameter setting, pressing **↑↓** or **↻** can change parameter index number, pressing **-** or **+** can change parameter value. After finishing the setting, press **i** key to return main interface.

3.8.4 Technical parameter setting



Press **i** + **✂** key simultaneously on the main interface, and then enter into the password interface of technical parameter setting. The other step is the same as the ordinary parameter setting in 3.8.3.

3.8.5 Monitor mode

Press **i** + **-** key simultaneously on the main interface, and then enter into monitor mode (Fig 3.27).

MONITOR-01
BusVoltage 0310

Fig 3.27 Monitor mode

Press  or  key to switch index of monitor mode and then view the different monitor parameters. Press  key to quit monitor mode and return the main interface.

Monitor parameter table :

Display	Parameter specification	Unit
01	Bus voltage	V
02	Motor speed	spm
03	Motor current	0.1A
04	Initial Angle of the motor	degree
05	Needle stop signal/Hall signal	
06	Pedal signal	
07	The controller software version number	
08	The controller software sub - version number	
09	HMI software version number	

3.9 Error and failure treatment

When there is a failure in the sewing machine, the main interface of system will display the failure content and code on the screen (Fig 3.28).

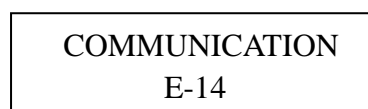

Fig 3.28 Failure display

Failure code table :

Failure code	Failure content	Solution
1	Hardware overcurrent	Close system power and open power again after 30 seconds. If the controller still can not work, please replace the controller and inform the manufacturer.
2	Software overcurrent	
3	System undervoltage	Disconnect the power of controller, and check the input voltage is low or not. If the voltage is low, and restarting the power still can not work after the voltage recovering, please replace the controller and inform the manufacturer.
4	Overvoltage during pausing	Disconnect the power of controller, and check the input voltage is low or not. If the voltage is high (over 245V) and restarting the power still can not work after the voltage recovering, please replace the controller and inform the manufacturer.
5	Overvoltage during running	
6	Motor block	Disconnect the power of controller, check the power plugs is off, loose and broken or not, and check there is some things enwind on the head of the motor. If restarting still cannot work after the solution, please replace the controller and inform the manufacturer.
7	Head needle stop signal failure	Check the connecting wire between the motor encoder or head synchronizer and controller is off, loose and broken or not. If restarting still cannot work after the solution, please replace the controller and inform the manufacturer.
8	Mainboard read and write EEPROM failure	Disconnect the power and restarting. If still display failure, please replace the controller and inform the manufacturer.
9	Overspeed failure	Disconnect the system power, and reconnect the power after 30 seconds. If the controller can not works, please replace the controller and inform the manufacturer.
10	Reversal failure	
11	Motor overload	
12	Current detection circuit failure	

13	Motor HALL failure	Check the connecting wire between the motor encoder and controller is off, loose and broken or not. If restarting still cannot work after the solution, please replace the controller and inform the manufacturer.
14	Communication failure	Check the connecting wire between the panel and the controller is off, loose and broken or not. If restarting still cannot work after the solution, please replace the controller and inform the manufacturer.
15	Pedal signal failure	Check the connecting wire between the pedal and the controller is off, loose and broken or not. If restarting still cannot work after the solution, please replace the controller and inform the manufacturer.
16	Electromagnet short circuit failure	Check the connecting wire of electromagnet is right, off, loose and broken or not. If have these phenomena, please replace the wire in time. If restarting still cannot work after the solution, please replace the controller and inform the manufacturer.
18	Sensor failure	Check the connecting wire between the panel and the controller is off, loose and broken or not. If restarting still cannot work after the solution, please replace the controller and inform the manufacturer.
19	Panel read and write EEPROM failure	Please restarting after disconnect the power. If still have a failure, please replace the controller and inform the manufacturer.

(Fifth) System reference instruction

4.1 Ordinary parameters list

No	Display	Controlled value	Parameter range	Reference value
Ordinary parameters				
1	P - 01	The lowest speed limit	300 - 1000	400
2	P - 02	The highest speed limit	300 - 7000	5000
3	P - 03	Soft starting function and needle number	0 - 9	0
4	P - 04	The highest speed of soft starting	300 - 1500	1200
5	P - 05	Acceleration	10 - 90	20
6	P - 06	Deceleration	10 - 90	50
7	P - 07	Retention	-	0
8	P - 08	Retention	-	3
9	P - 09	Overcurrent failure automatically recover switch	0:OFF 1:ON	1
10	P - 10	The maximum current setting	7 - 17	10
11	P - 11	Motor running direction	0: Reverse direction 1: Forward direction	1
12	P - 12	The needle stop sensor model	0:OFF 1:ON	1
13	P - 13	Start find the needle position	0:OFF 1:ON	0
14	P - 14	Needle stopping position selection	0: Down stop 1: Up stop	1
15	P - 15	Retention parameters	1	1
16	P - 16	Up needle stopping angle adjustment	0 - 23	1
17	P - 17	Down needle stopping angle adjustment	0 - 23	14
18	P - 18	Foot treadle curve model	0 - 4	0

19	P - 19	Foot treadle back step position	1 - 4090	300
20	P - 20	Foot treadle idle position adjustment	1 - 4090	500
21	P - 21	Treadle before stepping up the seam position	1 - 4090	830
22	P - 22	Treadle position at low running speed	1 - 4090	1300
23	P - 23	Treadle position at the highest running speed	1 - 4090	2400
24	P - 24	Automatic test run time	1 - 99	5
25	P - 25	Automatic test pause time	1 - 99	5
26	P - 26	Fill needle speed	300 - 1200	450
27	P - 27	Supplement needle sensitivity	100 - 500	200
28	P - 28	Rockover switch mode	0: Disconnection 1: connection	0
29	P - 29	Initial Angle of the motor	0 - 355	55
30	P - 30	Save the user - defined parameters	0:OFF 1:ON	0
31	P - 31	Restore the current starting motor factory parameters	8: Restore the factory parameter 6: Restore the user - defined parameters	0
32	P - 32	Motor type selection	0	0
33	P - 33	Motor running Green indicator switch	0 : Green light 1 : Green light off	0
34	P - 34	Emission intensity of f - sensor	0 - 100	100
35	P - 35	Retention parameters		50
36	P - 36	Retention parameters		50

Technical parameters					
37	P - 37	Retention parameters		x	63
38	P - 38	Retention parameters	Halfway air suction	x	63
39	P - 39	Retention parameters	Working mode	0:Semi - manual 1:Semi - automatic 2:Automatic pedal control 3:Automatic sensor control	0
40	P - 40	Retention parameters	Head lamp brightness	0 - 3 0:Go out 3 : Brightest	6
41	P - 41	Automatic seam sewing up the speed		800 - 4500	2500
42	P - 42	Air suction mode		0: Automatic suction close 1: Front trimming suction 2: Back trimming suction 3: Front and back trimming suction 4: Long air suction	2
43	P - 43	Suction opening time	Front suction opening needle number	0 - 10 0 : Off 10: On	0
44	P - 44	Retention parameters	Back suction opening needle number		0
45	P - 45	Back suction parameter 1	Intermission air suction opening needle number	1 - 50	30
46	P - 46	Back suction paramete2	Intermission air suction closeing needle number	1 - 50	10
47	P - 47	Retention parameters	Loose line switch		0
48	P - 48	Retention parameters	The needle number of opening		3
49	P - 49	Retention parameters	The needle number of closing		1

50	P - 50	Trimming solenoid valve keep time		10 - 1000	50
51	P - 51	Automatic press foot selection		0 - 3	3
52	P - 52	Press foot delay	Automatic lifting foot delay	10 - 300	50
53	P - 53	Retention parameters	Press foot delay	-	100
54	P - 54	Retention parameters		-	- 40
55	P - 55	Time of Press foot protection timeout		1 - 50	10
56	P - 56	Retention parameters			0
57	P - 57	Retention parameters	Automatic stop function		0
58	P - 58	Retention parameters	After step inspiratory function		0
59	P - 59	Retention parameters	Manual suction switch		0
60	P - 60	Retention parameters			0
61	P - 61	Sensor selection		0 : Normal close 1 : Normal open	0
62	P - 62	Starting sensor sewing delay		1 - 99	10
63	P - 63	Front electric eye sensitivity		10 - 1010	750
64	P - 64	The delayed needle number of s - sensor trimming	The needle number of front suction off	It is determined by the P - 71 parameter	3
65	P - 65	S - sensor threshold		10 - 1000	750
66	P - 66	The delayed needle number of t - sensor trimming	The needle number of after suction off	It is determined by the P - 72 parameter	1
67	P - 67	T - sensor threshold		10 - 1000	550

68	P - 68	Retention parameters		-	1
69	P - 69	Power - off protection function of motor		0 : Off 1 : On	0
70	P - 70	Starting sensor automatically stop	Reserve	0 - 10	1
71	P - 71	Before trimming the number of stitches threshold	Before door of stitches threshold	1 - 40	10
72	P - 72	After trimming the number of stitches threshold	After door of stitches threshold	1 - 40	20
73	P - 73	Trimming manual mode, suck Wind function quick adjustment	Electric scissors switch control manual mode	0 : Off 1 : On	1
75	P75		The needle number of suction	3 - 99	3
76	P76	-	The delayed needle number of automatic parking	3 - 99	10
84	P84	Retention parameters			

GN9000D

AUTOMATIC OVERLOCK MACHINE



This machine may only be operated by adequately trained operators only after having completely read and understood the instruction manual.

Parts are subject to changes in design without prior notice.



XI'AN TYPICAL INDUSTRIES CO., LTD.
No. 335, South Taibai Road
Xi'an 710068, P.R.China
Tel.: +86-29-88279093 // 88279150 // 88279151
Fax: +86-29-88249715 // 88245215

tic@chinatypical.com
www.chinatypical.com

VETRON TYPICAL EUROPE GmbH
Clara-Immerwahr-Str. 6
67661 Kaiserslautern, Germany
Tel.: +49 6301 320 75-0
Fax: +49 6301 320 75-11

info@vetrontypical.com
www.vetrontypical.com