

1

2

3

4

A

A

B

B

C

C

D

D

E

E

F

F

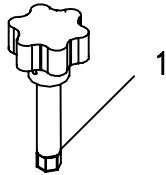
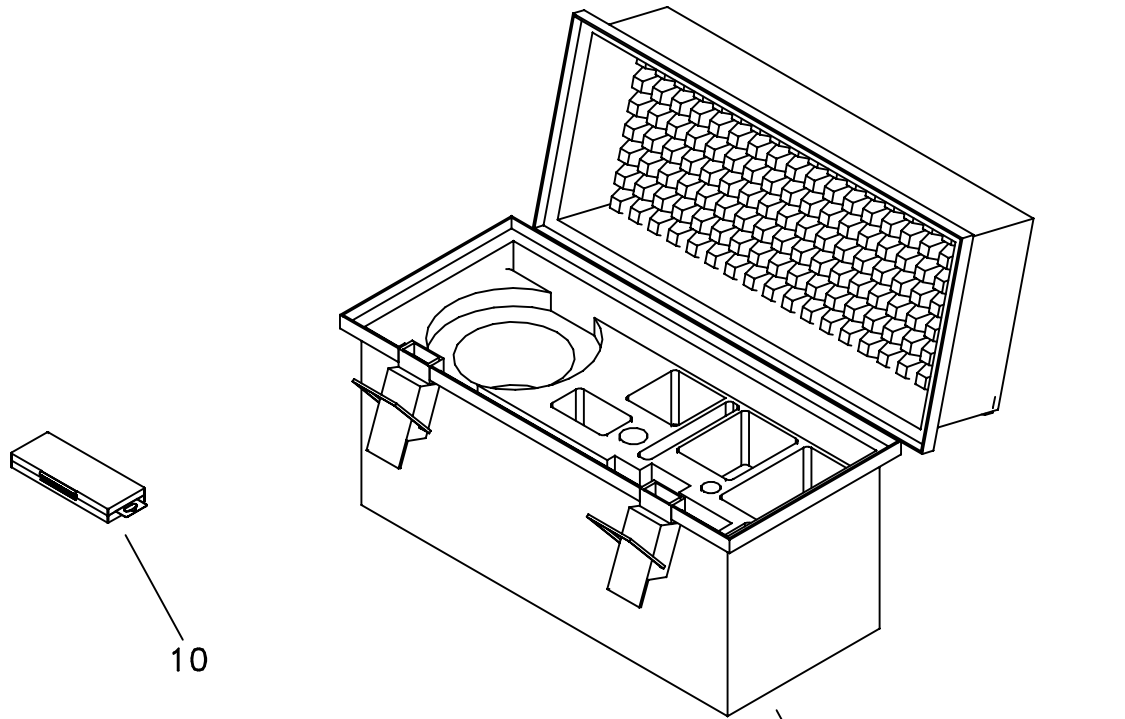

1

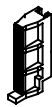

2

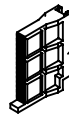

3

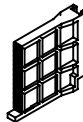

4

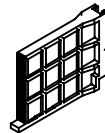

5

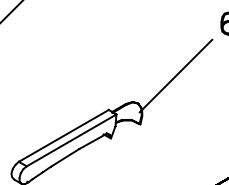

6



7



8

– 81299000 GRUPPO CASSETTA

n°	Cod.	Descrizione
1	71489000	CHIAVE SPECIALE
2	76629049A	PROLUNGA n.1
3	76629059A	PROLUNGA n.2
4	76629069A	PROLUNGA n.3
5	76629079A	PROLUNGA n.4
6	98420001	COLTELLO SBAVATUBO PICCOLO
7	61520000	GIRAVITE A CROCE 3x60
8	32450000	CONTENITORE TRASPARENTE UB 22x8/1
9	65000040	VALIGETTA DI TRASPORTO TIPO V06
10	32450010	CONTENITORE TRASPAR. C2A 137x52x17

( vedi tabella  
BRACCIO UTENSILE  
" COMPONENTI VARI " )

Approvato		Data		Sostituisce il 104/060 Rev.02		DE001789		Data 13/02/12		DE001995			
Disegnato da PASTO' M.		Data 05/02/14		Rev. n° 03		Rich. n° 30-2014		Sostituito da XXX/XXX XXXXXXXX Rev.xx		Data XX/XX/XX		Dis. n° 104/060	
				Denominazione GRUPPO CASSETTA RTC 315				Tot.Rev.n° 000		cod. 81299000			

1

2

3

4

Mod.XXXX