

ITEM	MDPE/QTY.	DESCRIPTION	PART NUMBER	MATERIAL
1	1	VST-500 I.G. @ 1.0 S.G.	1030-05862T-00-00	00 MDPE
2	1	18" THREADED MANWAY w/ BREATHER	9707-08016A-80-10	10 HDPE
3	1	2.0" [50 MM] BULKHEAD	9702-012000-65-02	PVC/EPDM
4	1	2.0" [50 MM] SIPHON LEG	9704-312000-00-02	02 PVC

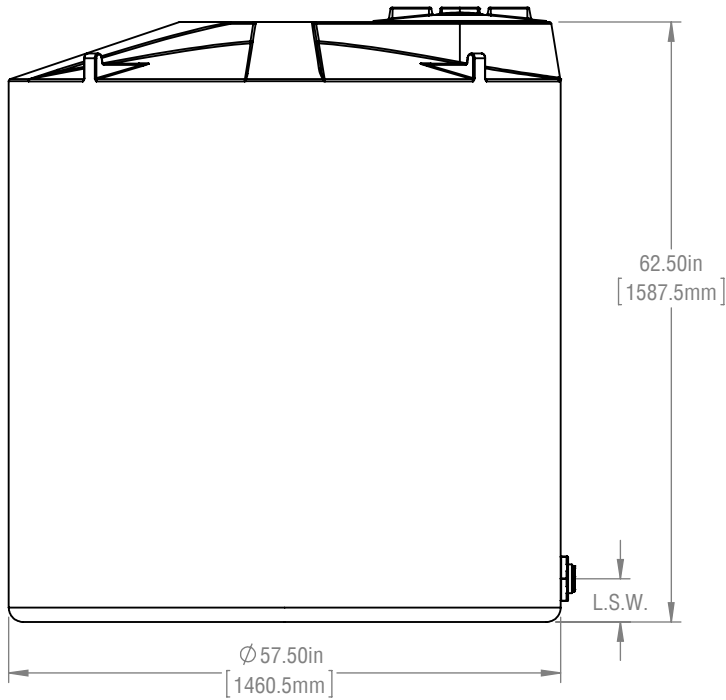
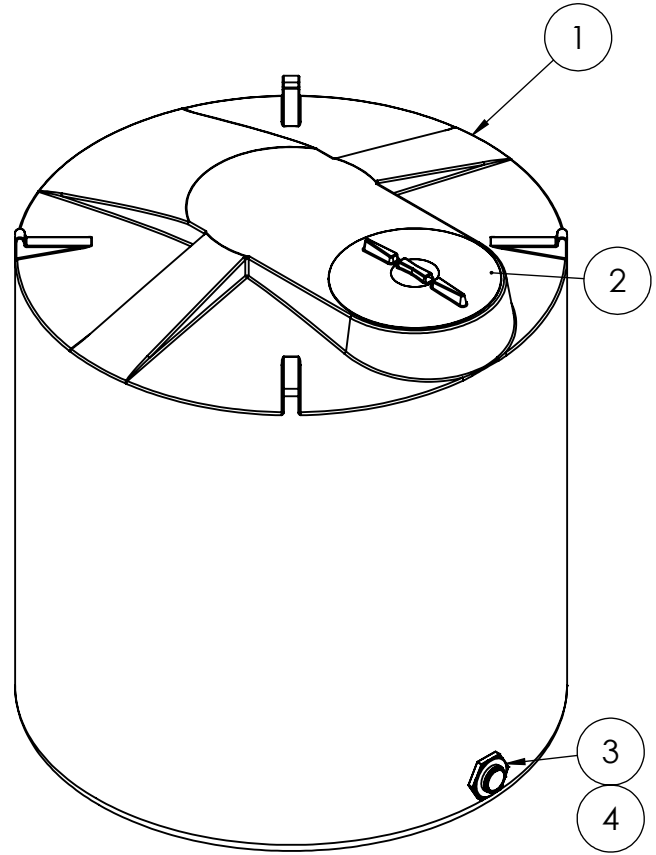
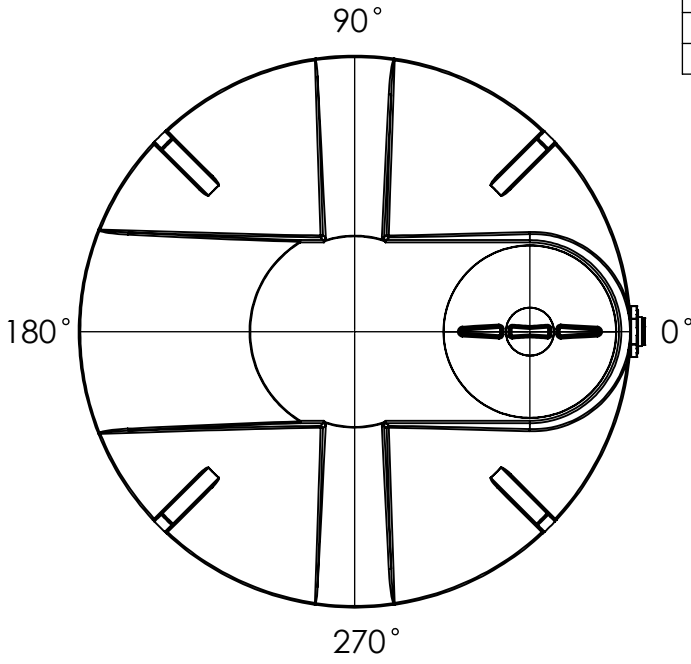

- NOTES:
 1) REFER TO PLAN VIEW FOR FITTING ORIENTATION
 2) ALL TRIMMED EDGES ARE ROUNDED OFF
 3) ALL DIMENSIONS ARE APPROXIMATE
 4) CAPACITY 500 IG (600 USG/2270 L)

FAILURE TO PROVIDE ADEQUATE PROVISIONS FOR TANK EXPANSION/CONTRACTION AT FITTINGS WILL VOID ALL WARRANTIES.

****TANK AVAILABLE IN 00 MDPE ONLY****

REVISIONS		
REV.	DESCRIPTION	DATE
00	KP - CREATED LAYOUT	08/05/2012

FINAL APPROVED DRAWING CUSTOMER:..... DATE:.....



RTS PLASTICS
 1027 INDUSTRIAL PLACE, PO Box 179,
 ST. CLEMENTS, ONTARIO, CANADA
 T:800-663-2803 F: 519-699-0027
 2900 INDUSTRIAL PARK DRIVE, PO Box 183,
 AUSTINBURG, OHIO, U.S.A.
 T:888-641-3077 F:440-275-3080

TOLERANCES UNLESS OTHERWISE STATED: X.X ±3% X.XX ±2% X.XXX ±1% ANGULAR ±3%

TITLE: **VST-500 I.G. (600 USG) AG TANK**

PART NUMBER: **1070-35862A-00-xx**
 CUSTOMER: **RTS COMPANIES INC.**
 DRAWN BY: **DH**
 MATERIAL: **PE**

REVISION: **00**
 PROJECT: **AG**
 DATE: **Oct 16, 2013**
 WEIGHT: