

ITEM	QTY.	DESCRIPTION	PART NUMBER	MATERIAL
1	1	CBT-30 I.G. @ 1.9 S.G.	1249-00035B-00-xx	PE
2	1	10" THREADED CAP w/ 7" ACCESS (WITH VENT)	9707-247000-80-00	10 HDPE

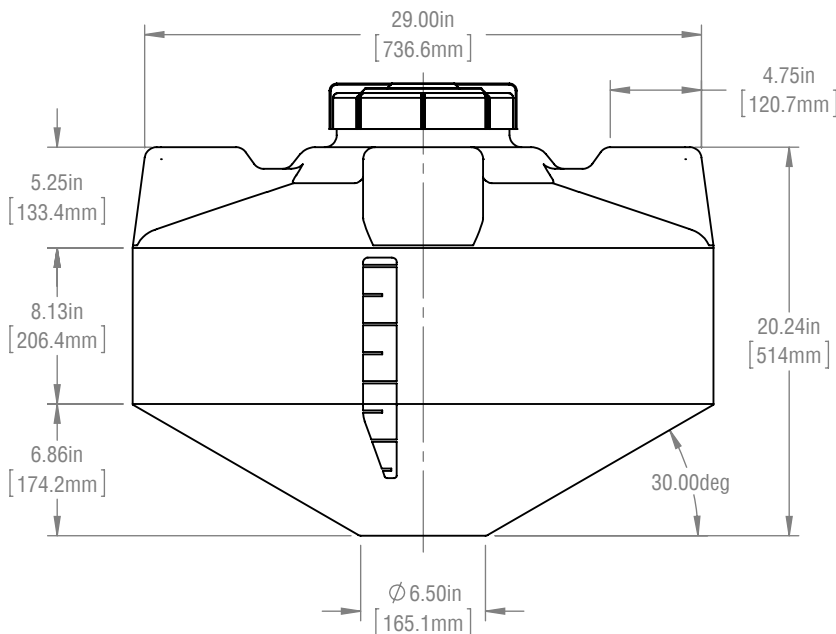
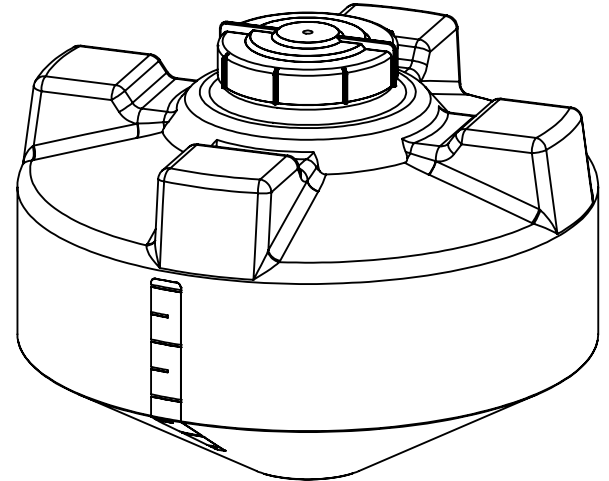
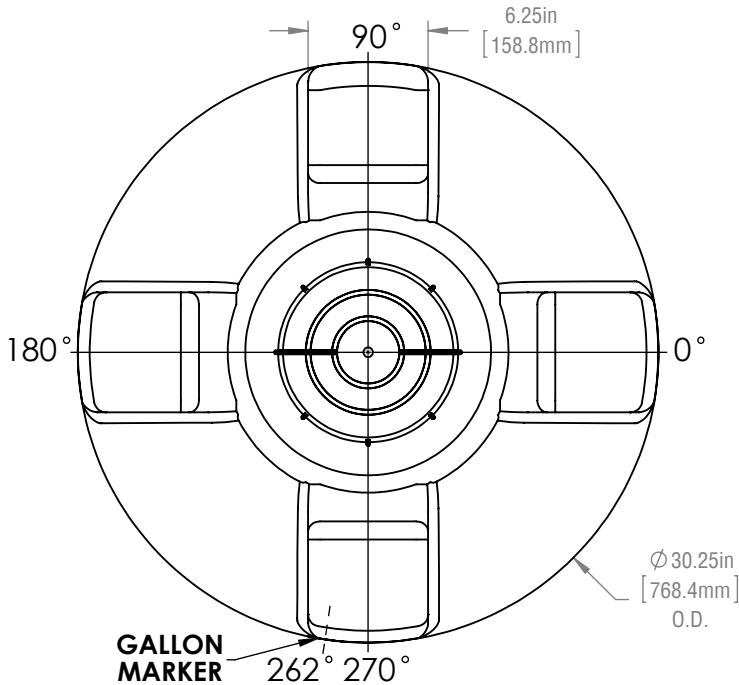

- NOTES:
 1) REFER TO PLAN VIEW FOR FITTING ORIENTATION
 2) ALL TRIMMED EDGES ARE ROUNDED OFF
 3) ALL DIMENSIONS ARE APPROXIMATE
 4) CAPACITY 30 IG (35 USG/130 L)

FAILURE TO PROVIDE ADEQUATE PROVISIONS FOR TANK EXPANSION/CONTRACTION AT FITTINGS WILL VOID ALL WARRANTIES.

****TANK ONLY AVAILABLE IN 10 HDPE****

REVISIONS		
REV.	DESCRIPTION	DATE
01	KP - UPDATED PART NUMBERS	12/08/2015

FINAL APPROVED DRAWING CUSTOMER:..... DATE:.....



RTS PLASTICS
 1027 INDUSTRIAL PLACE,
 ST. CLEMENTS, ONTARIO, CANADA
 T:800-663-2803 F: 519-699-0027
 2900 INDUSTRIAL PARK DRIVE,
 AUSTINBURG, OHIO, U.S.A.
 T:888-641-3077 F:440-275-3080

TOLERANCES UNLESS OTHERWISE STATED: X.X ±3% X.XX ±2% X.XXX ±1% ANGULAR ±3%

TITLE: **CBT-30 I.G. @ 1.9 S.G.**

PART NUMBER: **1249-00035B-00-xx**
 CUSTOMER: **RTS COMPANIES INC.**
 DRAWN BY: **DH**
 MATERIAL: **PE**

REVISION: **01**
 PROJECT: **CBT**
 DATE: **Jan 13, 2014**
 WEIGHT: **---**