

ITEM	QTY.	DESCRIPTION	PART NUMBER	MATERIAL
1	1	VOT-75 I.G. @ 1.9 S.G. (MODIFIED)	1019-02642T-00-xx	PE
2	1	VST-22XTB @ 1.9 S.G.	1089-02222T-00-xx	PE
3	1	8" THREADED MANWAY	9707-06008A-80-10	PE

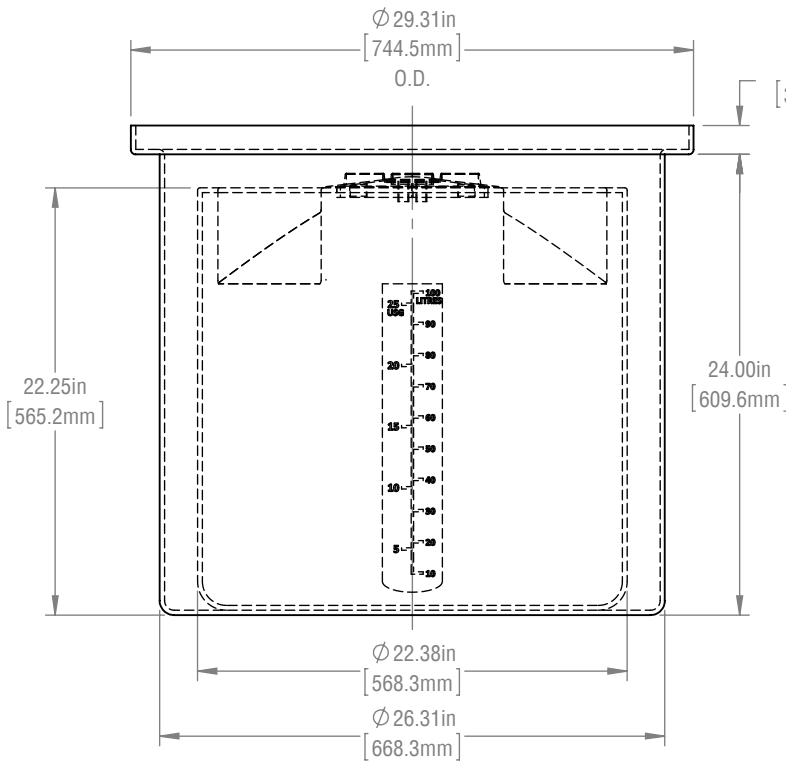
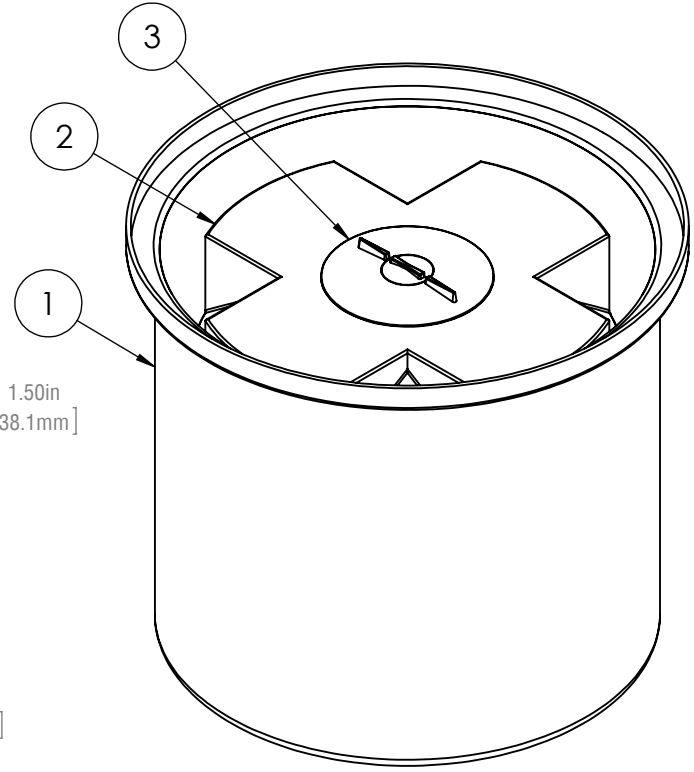
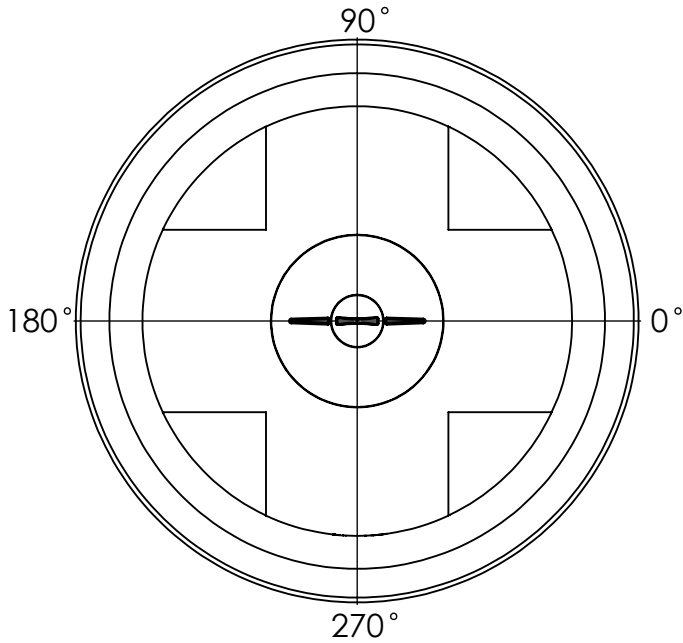

- NOTES:
 1) REFER TO PLAN VIEW FOR FITTING ORIENTATION
 2) ALL TRIMMED EDGES ARE ROUNDED OFF
 3) ALL DIMENSIONS ARE APPROXIMATE
 4) CAPACITY 22 IG (26 USG/100 L)

FAILURE TO PROVIDE ADEQUATE PROVISIONS FOR TANK EXPANSION/CONTRACTION AT FITTINGS WILL VOID ALL WARRANTIES.

****TANK AVAILABLE IN 00 MDPE OR 10 HDPE****

REVISIONS		
REV.	DESCRIPTION	DATE
01	DH - GENERAL UPDATE	2015-10-28

FINAL APPROVED DRAWING CUSTOMER:..... DATE:.....



RTS PLASTICS
 1027 INDUSTRIAL PLACE, PO Box 179,
 ST. CLEMENTS, ONTARIO, CANADA
 T:800-663-2803 F: 519-699-0027
 2900 INDUSTRIAL PARK DRIVE, PO Box 183,
 AUSTINBURG, OHIO, U.S.A.
 T:888-641-3077 F:440-275-3080

TOLERANCES UNLESS OTHERWISE STATED: X.X ±3% X.XX ±2% X.XXX ±1% ANGULAR ±3%

TITLE: **SCDTC-22XTB @ 1.9 S.G. in CYL. CONTAINMENT**

PART NUMBER: 1829-42222A-00-xx	REVISION: 01
CUSTOMER: RTS COMPANIES INC.	PROJECT: TBFT
DRAWN BY: DTH	DATE: Mar 19, 2014
MATERIAL: PE	WEIGHT: ---