

ITEM	QTY.	DESCRIPTION	PART NUMBER	MATERIAL
1	1	VOT-5 I.G. @ 1.9 S.G.	1019-01115T-00-xx	PE
2	1	11" CYL. SLIP COVER	1029-00011T-00-xx	PE

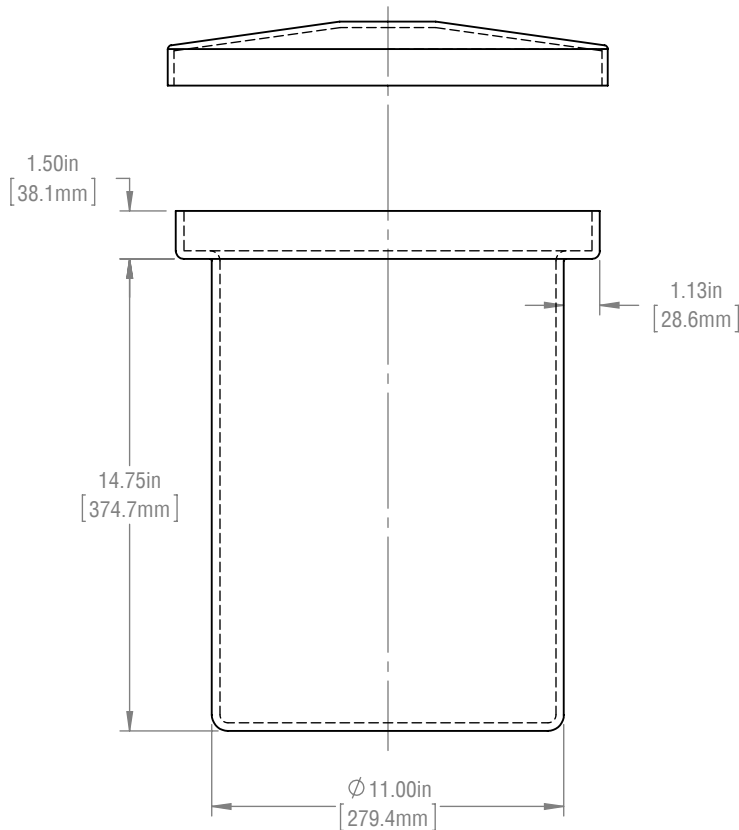
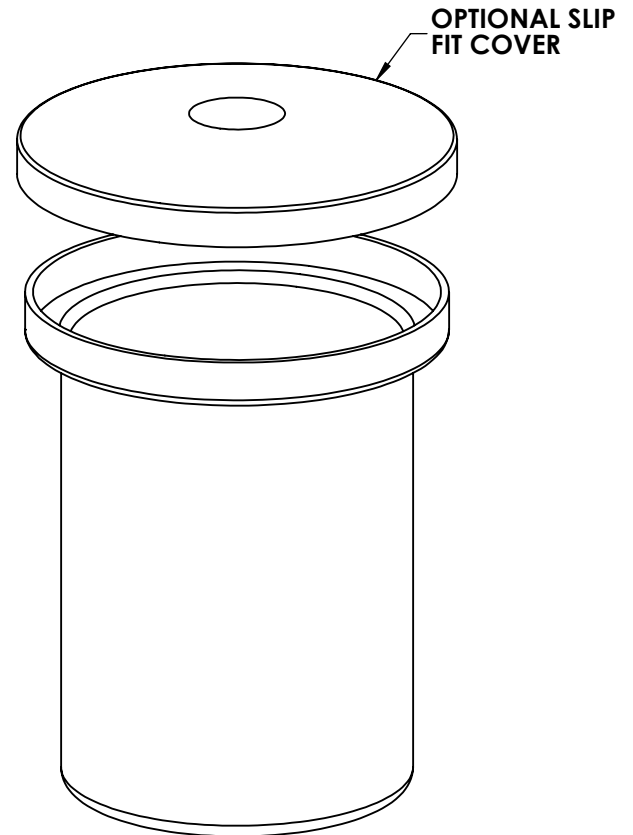
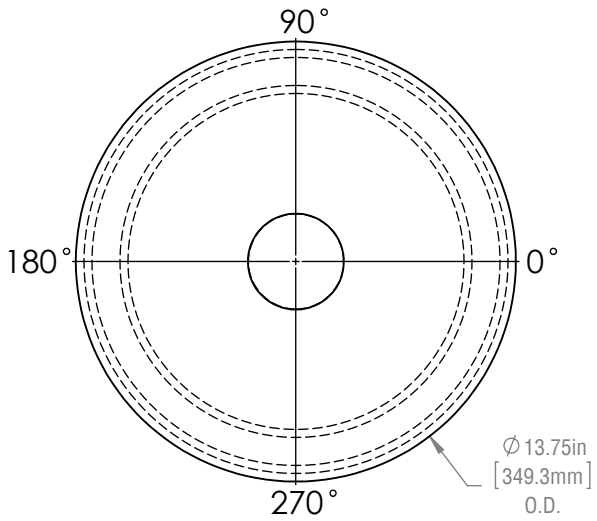

- NOTES:
- 1) REFER TO PLAN VIEW FOR FITTING ORIENTATION
 - 2) ALL TRIMMED EDGES ARE ROUNDED OFF
 - 3) ALL DIMENSIONS ARE APPROXIMATE
 - 4) CAPACITY 5 IG (6 USG/23 L)

FAILURE TO PROVIDE ADEQUATE PROVISIONS FOR TANK EXPANSION/CONTRACTION AT FITTINGS WILL VOID ALL WARRANTIES.

****TANK AVAILABLE IN 00 MDPE OR 10 HDPE****

REVISIONS		
REV.	DESCRIPTION	DATE
01	DH - REVISED PART NUMBER	2015-06-26

FINAL APPROVED DRAWING CUSTOMER:..... DATE:.....



RTS PLASTICS
 1027 INDUSTRIAL PLACE,
 ST. CLEMENTS, ONTARIO, CANADA
 T:800-663-2803 F: 519-699-0027
 2900 INDUSTRIAL PARK DRIVE,
 AUSTINBURG, OHIO, U.S.A.
 T:888-641-3077 F:440-275-3080

TOLERANCES UNLESS OTHERWISE STATED: X.X ±3% X.XX ±2% X.XXX ±1% ANGULAR ±3%

TITLE: **VOT-5 I.G. @ 1.9 S.G.**

PART NUMBER: **1019-01115T-00-xx**
 CUSTOMER: **RTS COMPANIES INC.**
 DRAWN BY: **DTH**
 MATERIAL: **PE**

REVISION: **01**
 PROJECT: **VOT**
 DATE: **Feb 18, 2014**
 WEIGHT: **---**