

ITEM	QTY.	DESCRIPTION	PART NUMBER	MATERIAL
1	1	VST-80 I.G. @ 1.9 S.G.	1039-02450T-00-xx	PE
2	1	6" SCREW CAP	9707-016000-80-10	10 HDPE
3	1	6" SCREW CAP GASKET	9707-056000-00-65	65 EPDM
4	1	1.0" [25 MM] FNPT BOSS	9701-011000-00-00	00 MDPE

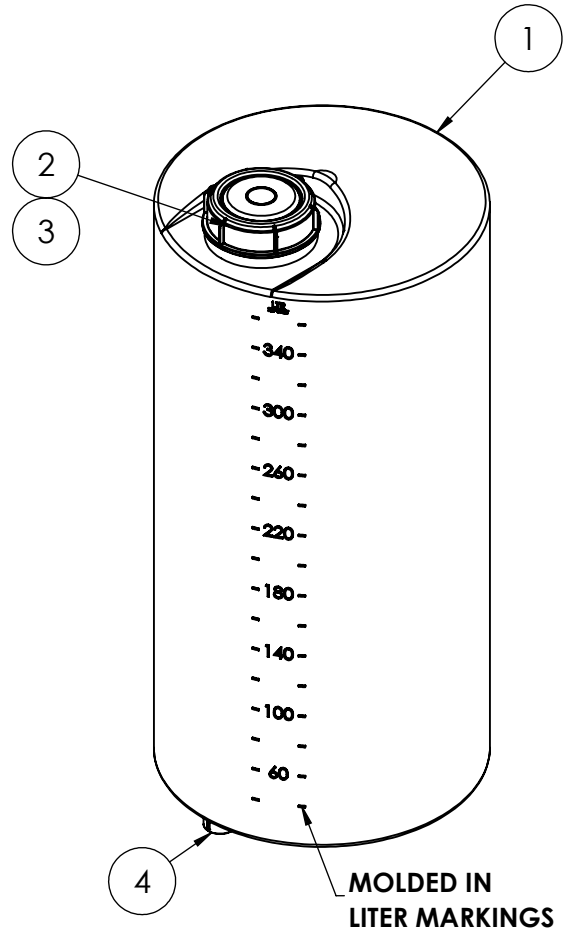
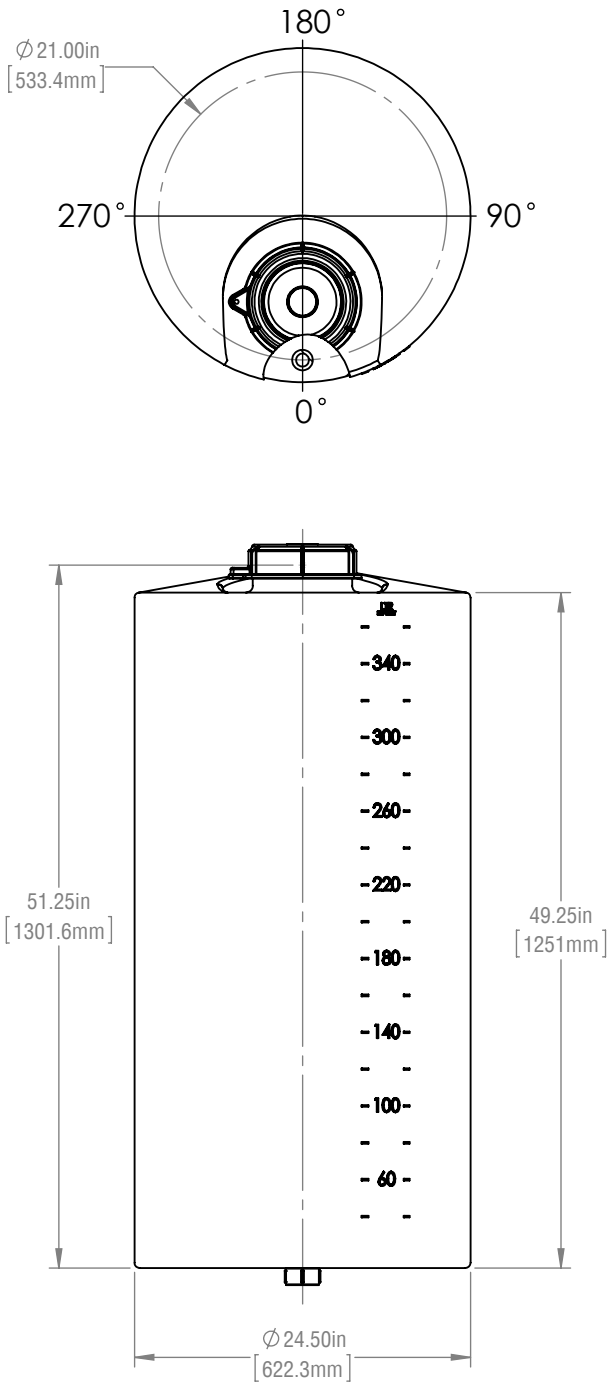

- NOTES:
 1) REFER TO PLAN VIEW FOR FITTING ORIENTATION
 2) ALL TRIMMED EDGES ARE ROUNDED OFF
 3) ALL DIMENSIONS ARE APPROXIMATE
 4) CAPACITY 80 IG (95 USG/360 L)

FAILURE TO PROVIDE ADEQUATE PROVISIONS FOR TANK EXPANSION/CONTRACTION AT FITTINGS WILL VOID ALL WARRANTIES.

****TANK AVAILABLE IN 00 MDPE OR 10 HDPE****

REVISIONS		
REV.	DESCRIPTION	DATE
00	KP - CREATED LAYOUT	2016-03-17

FINAL APPROVED DRAWING CUSTOMER:..... DATE:.....



RTS PLASTICS
 1027 INDUSTRIAL PLACE,
 ST. CLEMENTS, ONTARIO, CANADA
 T:800-663-2803 F: 519-699-0027
 2900 INDUSTRIAL PARK DRIVE,
 AUSTINBURG, OHIO, U.S.A.
 T:888-641-3077 F:440-275-3080

TOLERANCES UNLESS OTHERWISE STATED: X.X ±3% X.XX ±2% X.XXX ±1% ANGULAR ±3%

TITLE: **DSPT-80 I.G. @ 1.9 S.G.**

PART NUMBER: **1859-12450A-00-xx**
 CUSTOMER: **RTS COMPANIES INC.**
 DRAWN BY: **DTH**
 MATERIAL: **PE**

REVISION: **00**
 PROJECT: **DSPT**
 DATE: **Mar 22, 2016**
 WEIGHT: **---**