

ITEM	QTY.	DESCRIPTION	PART NUMBER	MATERIAL
1	1	DWCT-4600 I.G. @ 1.5 S.G.	1255-05500B-00-xx	PE
2	1	18" THREADED MANWAY w/ 15 ACCESS	9707-240150-80-00	PE

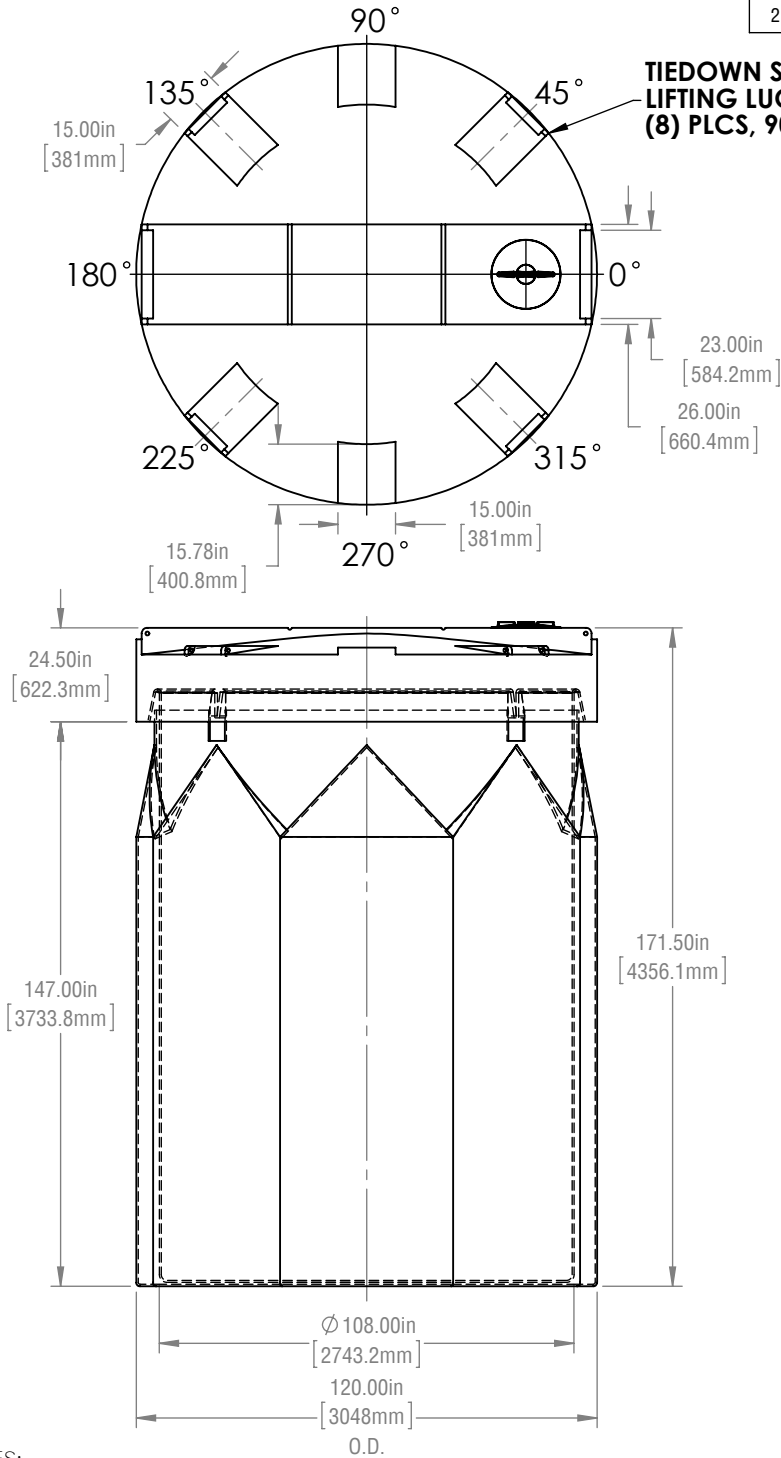

**TIEDOWN SUPPORT/
LIFTING LUG
(8) PLCS, 90° TYP.**

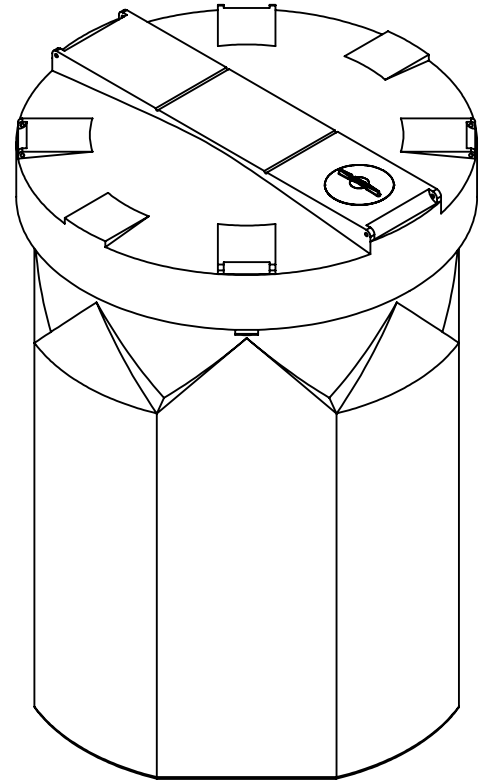

- NOTES:
 1) REFER TO PLAN VIEW FOR FITTING ORIENTATION
 2) ALL TRIMMED EDGES ARE ROUNDED OFF
 3) ALL DIMENSIONS ARE APPROXIMATE
 4) CAPACITY 4600 IG (5500 USG/20,800 L)

FAILURE TO PROVIDE ADEQUATE PROVISIONS FOR TANK EXPANSION/CONTRACTION AT FITTINGS WILL VOID ALL WARRANTIES.

****TANK AVAILABLE IN 09 XLPE OR 10 HDPE****

REVISIONS		
REV.	DESCRIPTION	DATE
01	DH - GENERAL UPDATE	2015-10-08

FINAL APPROVED DRAWING CUSTOMER:..... DATE:.....



RTS PLASTICS
 1027 INDUSTRIAL PLACE, PO Box 179,
 ST. CLEMENTS, ONTARIO, CANADA
 T:800-663-2803 F: 519-699-0027
 2900 INDUSTRIAL PARK DRIVE, PO Box 183,
 AUSTINBURG, OHIO, U.S.A.
 T:888-641-3077 F:440-275-3080

TOLERANCES UNLESS OTHERWISE STATED: X.X ±3% X.XX ±2% X.XXX ±1% ANGULAR ±3%

TITLE: **DWCT-4600 I.G. @ 1.5 S.G.**

PART NUMBER: 1255-05500B-00-xx	REVISION: 01
CUSTOMER: RTS COMPANIES INC.	PROJECT: DWCT
DRAWN BY: DTH	DATE: Feb 06, 2014
MATERIAL: PE	WEIGHT: ---