

ITEM	QTY.	DESCRIPTION	PART NUMBER	MATERIAL
1	1	VOT-175 I.G. @ 1.9 S.G.	1019-03648T-00-xx	PE
2	1	36" CYL. SLIP COVER	1029-00036T-00-xx	PE

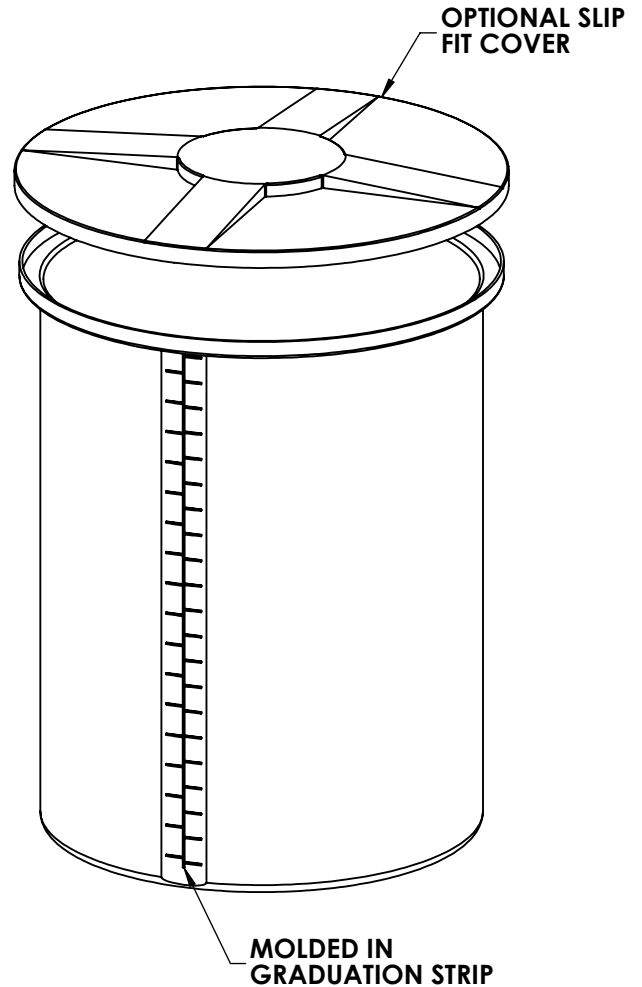
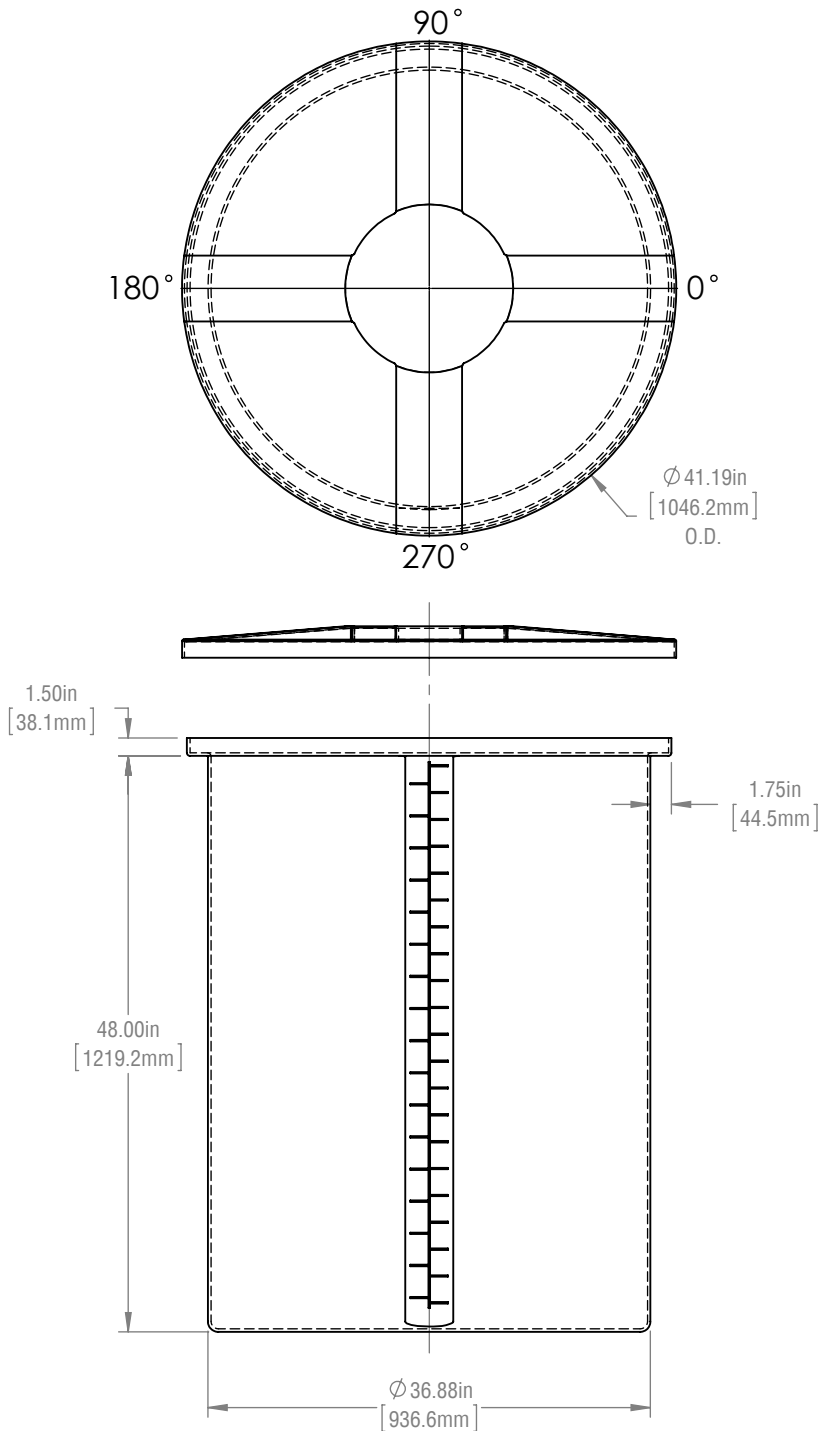

- NOTES:
- 1) REFER TO PLAN VIEW FOR FITTING ORIENTATION
  - 2) ALL TRIMMED EDGES ARE ROUNDED OFF
  - 3) ALL DIMENSIONS ARE APPROXIMATE
  - 4) CAPACITY 175 IG (210 USG/800 L)

FAILURE TO PROVIDE ADEQUATE PROVISIONS FOR TANK EXPANSION/CONTRACTION AT FITTINGS WILL VOID ALL WARRANTIES.

**\*\*TANK AVAILABLE IN 00 MDPE OR 10 HDPE\*\***

REVISIONS		
REV.	DESCRIPTION	DATE
01	DH - REVISED PART NUMBER	2015-07-17

FINAL APPROVED DRAWING CUSTOMER:..... DATE:.....



**RTS PLASTICS**  
 1027 INDUSTRIAL PLACE,  
 ST. CLEMENTS, ONTARIO, CANADA  
 T:800-663-2803 F: 519-699-0027  
 2900 INDUSTRIAL PARK DRIVE,  
 AUSTINBURG, OHIO, U.S.A.  
 T:888-641-3077 F:440-275-3080

TOLERANCES UNLESS OTHERWISE STATED: X.X ±3% X.XX ±2% X.XXX ±1% ANGULAR ±3%

TITLE: **VOT-175 I.G. @ 1.9 S.G.**

PART NUMBER: **1019-03648T-00-xx**  
 CUSTOMER: **RTS COMPANIES INC.**  
 DRAWN BY: **DTH**  
 MATERIAL: **PE**

REVISION: **01**  
 PROJECT: **VOT**  
 DATE: **Feb 19, 2014**  
 WEIGHT: **---**