

ITEM	QTY.	DESCRIPTION	PART NUMBER	MATERIAL
1	1	VST-125 I.G. @ 1.9 S.G.	1039-04625T-00-xx	PE
2	1	6" SCREW CAP	9707-016000-80-10	10 HDPE
3	1	6" SCREW CAP GASKET	9707-056000-00-66	66 VITON

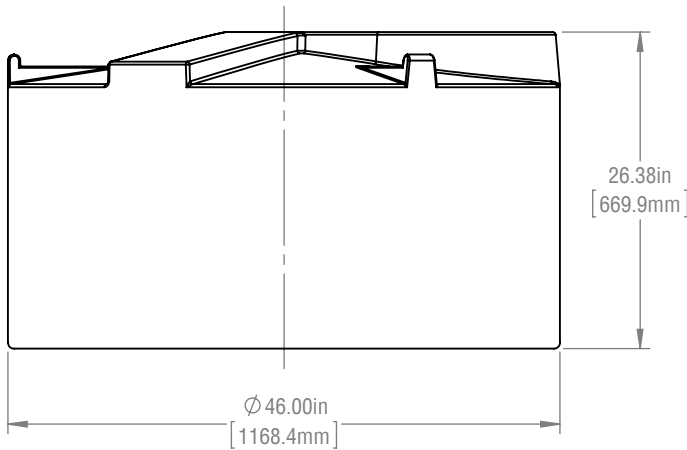
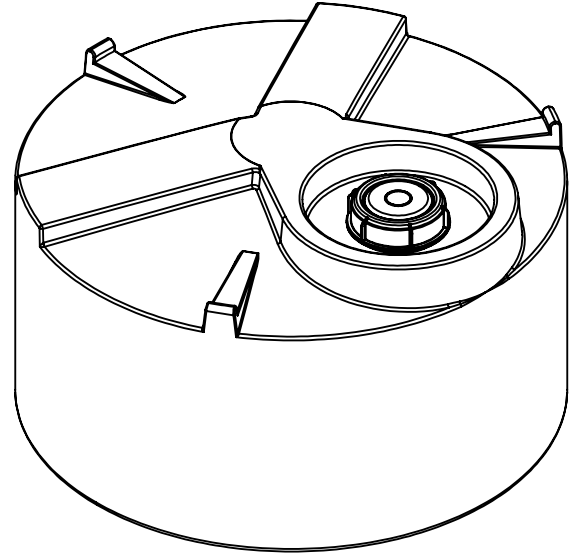
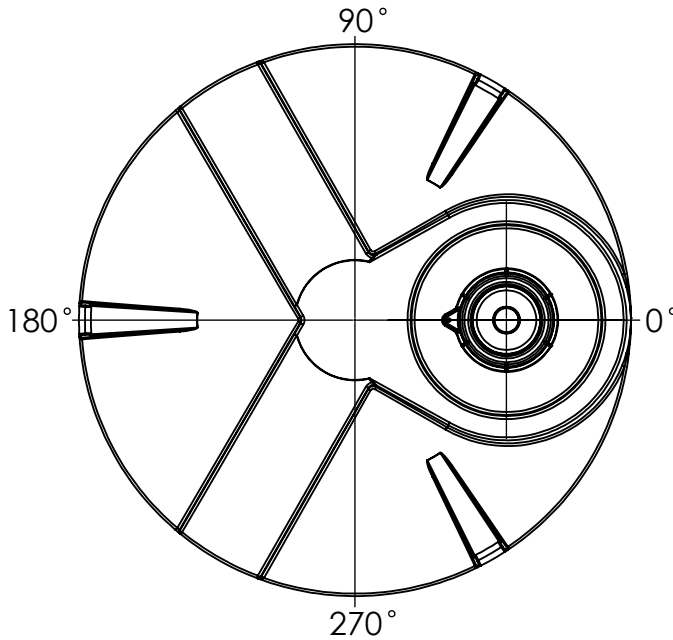

- NOTES:
- 1) REFER TO PLAN VIEW FOR FITTING ORIENTATION
 - 2) ALL TRIMMED EDGES ARE ROUNDED OFF
 - 3) ALL DIMENSIONS ARE APPROXIMATE
 - 4) CAPACITY 125 IG (150 USG/565 L)

FAILURE TO PROVIDE ADEQUATE PROVISIONS FOR TANK EXPANSION/CONTRACTION AT FITTINGS WILL VOID ALL WARRANTIES.

****TANK AVAILABLE IN 00 MDPE, OR 10 HDPE****

REVISIONS		
REV.	DESCRIPTION	DATE
00	KP - UPDATED PART NUMBERS	08/05/2012

FINAL APPROVED DRAWING CUSTOMER:..... DATE:.....



RTS PLASTICS
 1027 INDUSTRIAL PLACE, PO Box 179,
 ST. CLEMENTS, ONTARIO, CANADA
 T:800-663-2803 F: 519-699-0027
 2900 INDUSTRIAL PARK DRIVE, PO Box 183,
 AUSTINBURG, OHIO, U.S.A.
 T:888-641-3077 F:440-275-3080

TOLERANCES UNLESS OTHERWISE STATED: X.X ±3% X.XX ±2% X.XXX ±1% ANGULAR ±3%

TITLE: **VST-125 I.G. @ 1.9 S.G.**

PART NUMBER: 1039-24625A-00-xx	REVISION: 00
CUSTOMER: RTS COMPANIES INC.	PROJECT: VST
DRAWN BY: DH	DATE: Oct 16, 2013
MATERIAL: PE	WEIGHT: ---