

ITEM	QTY.	DESCRIPTION	PART NUMBER	MATERIAL
1	1	DCT-125 I.G. @ 1.9 S.G.	1269-00150B-00-xx	PE
2	1	14" THREADED MANWAY w/ 11-1/4" ACCESS	9707-240140-80-00	PE

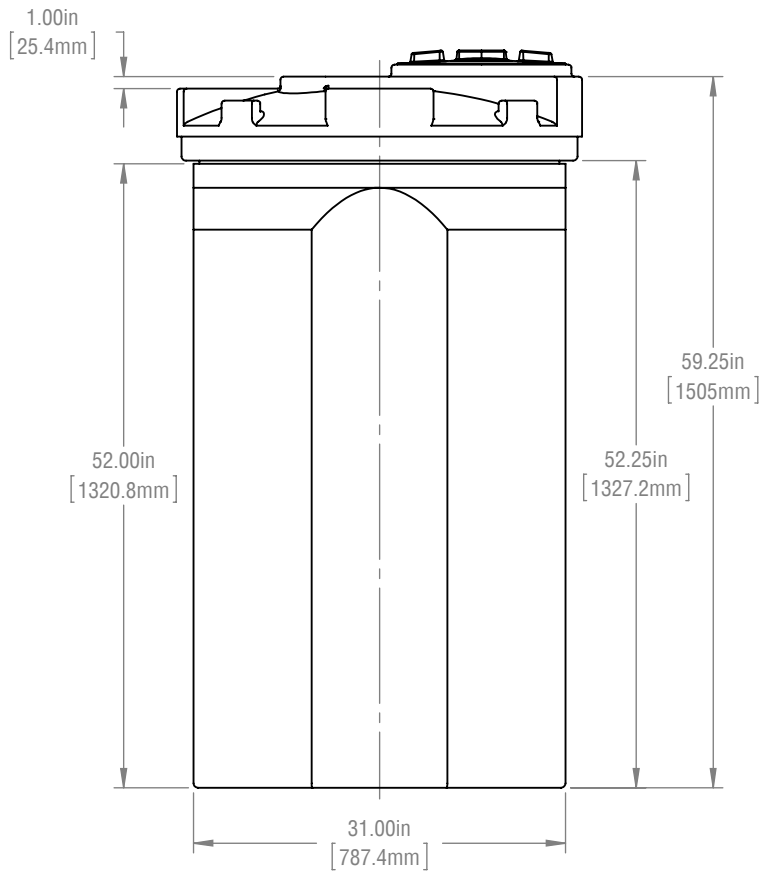

TIE-DOWN
4 PLCS TYP.

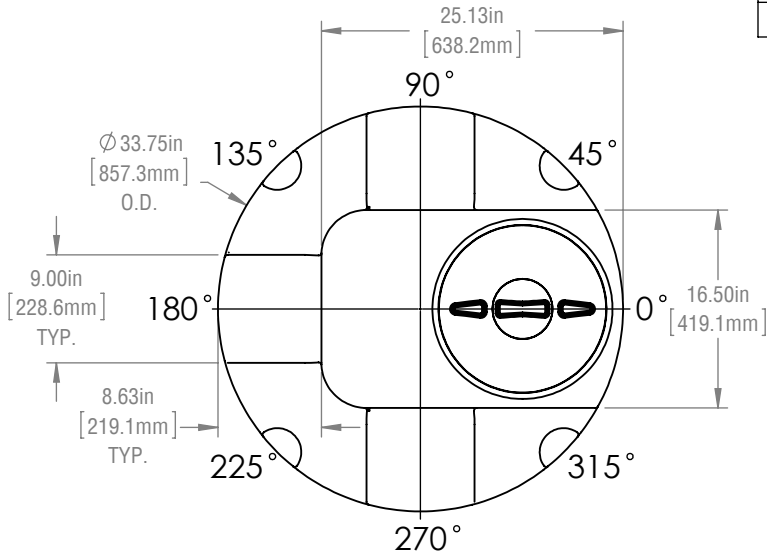
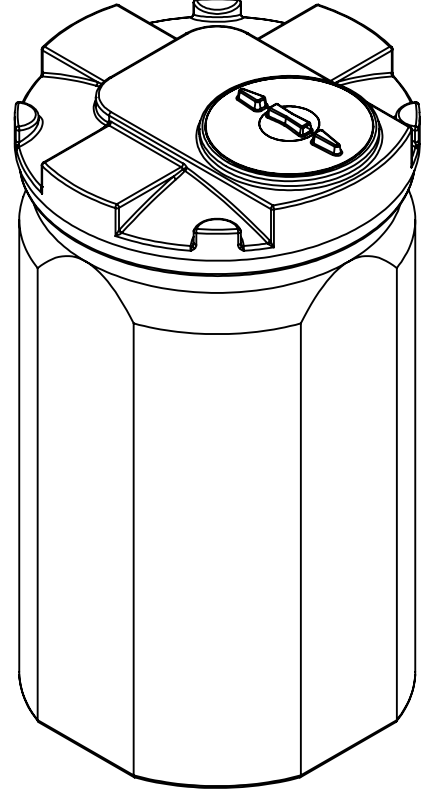

- NOTES:
 1) REFER TO PLAN VIEW FOR FITTING ORIENTATION
 2) ALL TRIMMED EDGES ARE ROUNDED OFF
 3) ALL DIMENSIONS ARE APPROXIMATE
 4) CAPACITY 125 IG (150 USG/565 L)

FAILURE TO PROVIDE ADEQUATE PROVISIONS FOR TANK EXPANSION/CONTRACTION AT FITTINGS WILL VOID ALL WARRANTIES.

****TANK AVAILABLE IN 09 XLPE OR 10 HDPE****

REVISIONS		
REV.	DESCRIPTION	DATE
02	DH - GENERAL UPDATE	2015-10-07

FINAL APPROVED DRAWING CUSTOMER:..... DATE:.....



RTS PLASTICS
 1027 INDUSTRIAL PLACE, PO Box 179,
 ST. CLEMENTS, ONTARIO, CANADA
 T:800-663-2803 F: 519-699-0027
 2900 INDUSTRIAL PARK DRIVE, PO Box 183,
 AUSTINBURG, OHIO, U.S.A.
 T:888-641-3077 F:440-275-3080

TOLERANCES UNLESS OTHERWISE STATED: X.X ±3% X.XX ±2% X.XXX ±1% ANGULAR ±3%

TITLE: **DCT-125 I.G. @ 1.9 S.G.**

PART NUMBER: **1269-00150B-00-xx**
 CUSTOMER: **RTS COMPANIES INC.**
 DRAWN BY: **DTH**
 MATERIAL: **PE**

REVISION: **02**
 PROJECT: **DWCT**
 DATE: **Feb 14, 2014**
 WEIGHT: **--**