

ITEM	QTY.	DESCRIPTION	PART NUMBER	MATERIAL
1	1	VOT-400 I.G. @ 1.5 S.G.	1015-04862T-00-xx	PE
2	1	48" CYL. SLIP COVER	1029-00048T-00-xx	PE

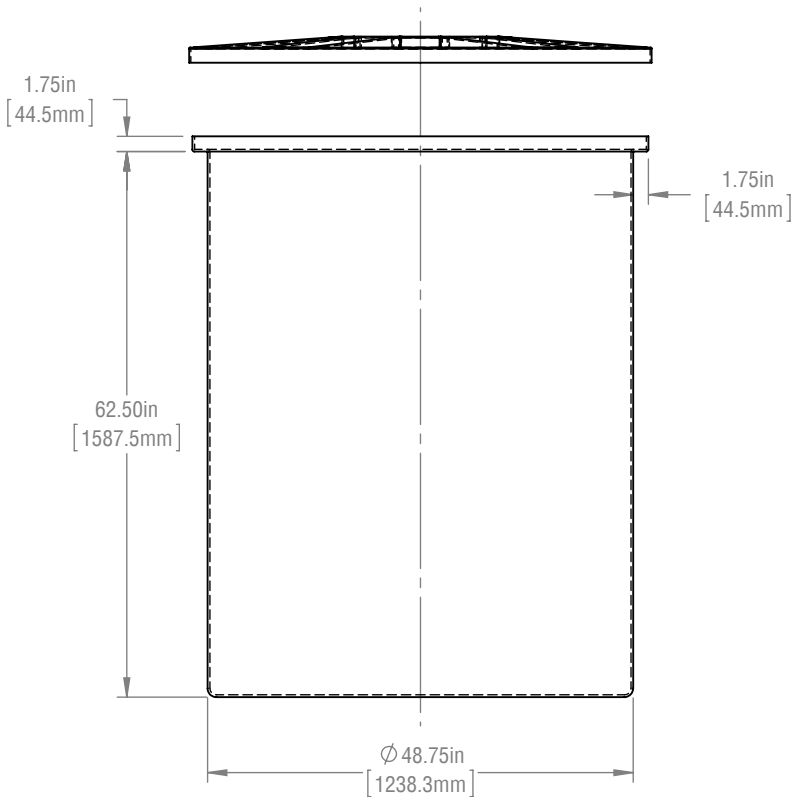
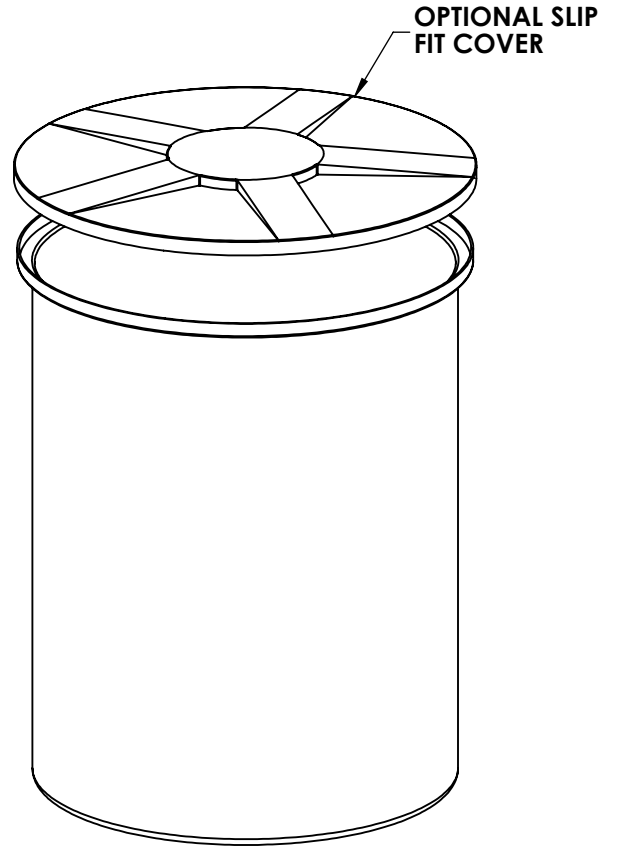
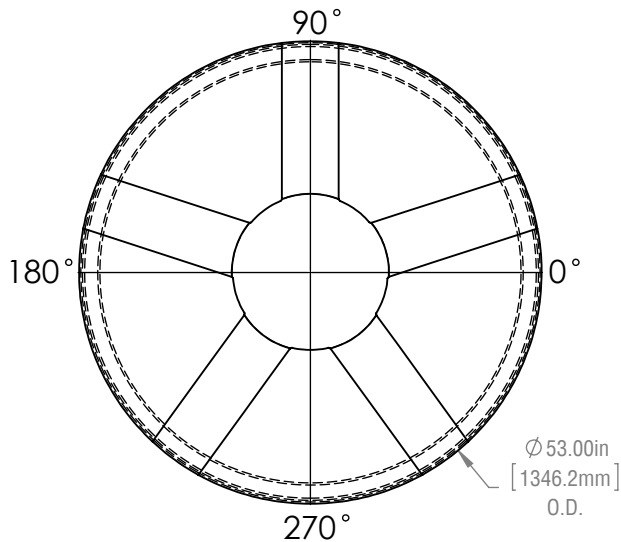

- NOTES:
- 1) REFER TO PLAN VIEW FOR FITTING ORIENTATION
 - 2) ALL TRIMMED EDGES ARE ROUNDED OFF
 - 3) ALL DIMENSIONS ARE APPROXIMATE
 - 4) CAPACITY 400 IG (480 USG/1820 L)

FAILURE TO PROVIDE ADEQUATE PROVISIONS FOR TANK EXPANSION/CONTRACTION AT FITTINGS WILL VOID ALL WARRANTIES.

****TANK AVAILABLE IN 00 MDPE OR 10 HDPE****

REVISIONS		
REV.	DESCRIPTION	DATE
01	DH - REVISED PART NUMBER	2015-06-25

FINAL APPROVED DRAWING CUSTOMER:..... DATE:.....



RTS PLASTICS
 1027 INDUSTRIAL PLACE,
 ST. CLEMENTS, ONTARIO, CANADA
 T:800-663-2803 F: 519-699-0027
 2900 INDUSTRIAL PARK DRIVE,
 AUSTINBURG, OHIO, U.S.A.
 T:888-641-3077 F:440-275-3080

TOLERANCES UNLESS OTHERWISE STATED: X.X ±3% X.XX ±2% X.XXX ±1% ANGULAR ±3%

TITLE: **VOT-400 I.G. @ 1.5 S.G.**

PART NUMBER: **1015-04862T-00-xx**
 CUSTOMER: **RTS COMPANIES INC.**
 DRAWN BY: **DTH**
 MATERIAL: **PE**

REVISION: **01**
 PROJECT: **VOT**
 DATE: **Feb 19, 2014**
 WEIGHT: **---**