

Cassida[®]
Cube

Moving money forward

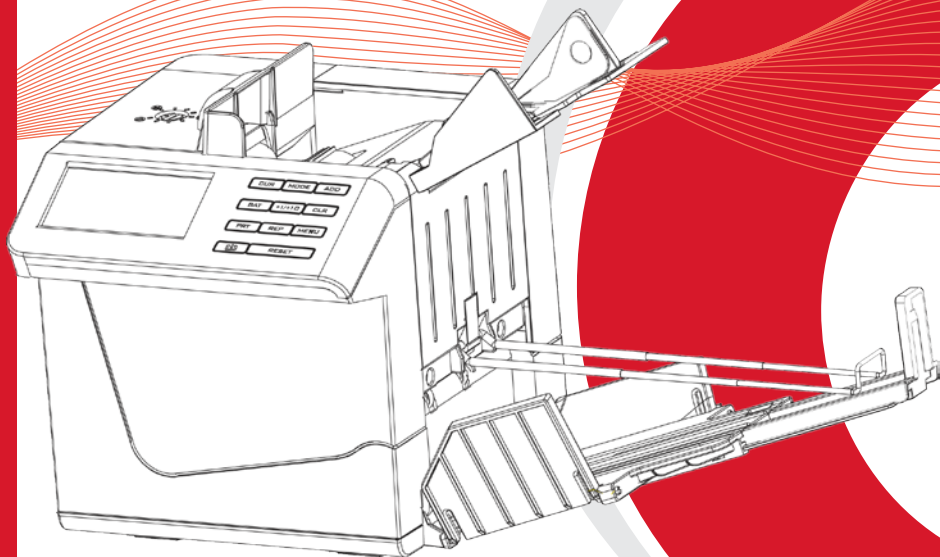

USER MANUAL

CASSIDA CUBE MIXED BILL COUNTER

This manual contains important information on safety measures and operational features of the Cassida Cube Mixed Bill Counter. Please read it carefully before operating your mixed bill counter and keep it handy for future reference.



Table of contents:

1. INTRODUCTION	2
1.1 About the Cassida Cube	2
1.2 Box contents	2
1.3 Front and rear views	3
1.4 Control panel	4
1.5 Specifications	5
1.6 Important safety notes	6
2. GETTING STARTED	7
2.1 Open the stacker assembly	7
2.2 Open and adjust the hopper	8
2.3 Open tilt stand	8
2.4 Connect the power source	9
2.5 Install the battery	9
3. LOADING BILLS	10
4. OPERATION	12
4.1 Select Auto/Manual mode	12
4.2 Select counting mode	12
4.3 Printing function	14
4.4 Select accumulative counting	15
4.5 Select batch counting	15
5. SLEEP AND TIME SETTINGS	16
6. TROUBLESHOOTING	17
6.1 Self-test error message display and solutions	17
6.2 Defective bill error message display and solutions	19
7. MAINTENANCE, WARRANTY AND CONTACT INFORMATION	20
7.1 Maintenance	20
7.2 Warranty	20
7.3 Shipping	21
7.4 Contact information	21

1. INTRODUCTION

1.1 About the Cassida Cube

Thank you for choosing the Cassida Cube compact value counter. We hope you enjoy using it.

The Cassida Cube is the most sophisticated compact mixed value counter on the market today. It applies the latest technology to give you the ultimate in counting performance and counterfeit detection.

1.2 Box contents

- Cassida Cube value counter
- AC/DC power adapter
- User manual and quickstart guide
- Cleaning brush
- Print transfer cable
- 2 calibration cards
- USB download cable (optional)
- Micro-printer (optional)
- Micro SD-card (optional)
- Rechargeable battery (optional)
- External LCD display (optional)

1.3 Front and rear views

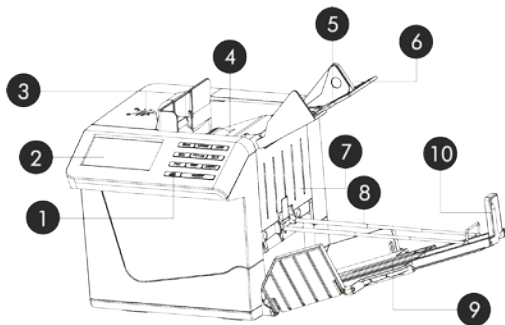

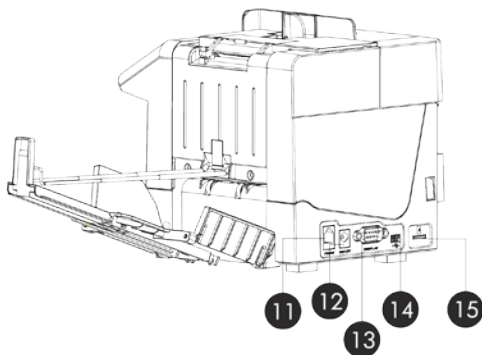

1. Control panel
2. LCD display screen
3. Adjusting screw
4. Main body
5. Hopper
6. Hopper guide
7. Front housing
8. Bill pressing frame
9. Stacker
10. Bill receiving adjustable plate

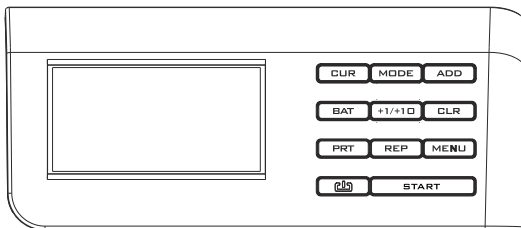

11. Printer interface
12. Power socket
13. External display interface
14. USB interface
15. Micro-SD card socket

1.4 Control panel



- CUR** : Press this key to select currency type or piece count (simple count mode)
- MODE** : Press this key to select a counting mode: Mix & Sort (when currency is selected)
- ADD** : Press this key to enter the ADD function (accumulative counting)
- BATCH** : Press this key to set the batch function
- +1/+10** : Use this key to increase the batch number by 1 (just press) or by 10 (press and hold)
- CLR** : Clear count memory
- PRT** : Press and hold this key to print the counting result report
- REP** : Press this key to view the counting result report
- MENU** : Press this key to enter setting function menu
-  : Press and hold this key to turn on/off the machine

START : Press **START** to start/stop counting. Press **START** once to stop counting, press again to continue

LCD display screen : Displays counting result or error message

1.5 Specifications

Counting speed:	250 bills/min
Hopper capacity:	100 bills
Stacker capacity:	100 bills
Batch size:	100, 50, 25, 20,10 or from 1 to 200 with +1/+10
Display:	LCD
Detections:	3D, MG, IR, UV, IMG, RGB
Power input:	AC100~240VAC, 50/60 Hz
Power output:	DC12V 12.0A
Battery:	2000 mAH
Operating temperature:	32 - 104 °F (0-40 °C)
Storage temperature:	-13 - 149 °F (-25 - +65 °C)
Size:	6.6" x 5.9"x 5.9" (170x150x150 mm)
Weight:	4.2 lbs (1.9 kg)

1.6 Important safety notes

When using this unit, basic safety precautions should always be observed, including the following:

- Read this manual before operation
- The manual should be available to operator
- Do not use this unit in areas where it may be exposed to water or any other liquids
- Make certain the unit is installed on a flat surface. Do not operate the machine in areas with high temperature, humidity or smoke, as these conditions may prevent proper operation.
- This unit is designed for indoor use in a ventilated environment. Keep the machine away from direct sunlight or strong directional interior lighting and strong magnetic fields. These could interfere with the counterfeit detection sensors.
- During operation, do not touch the moving parts of the unit
- Avoid foreign objects, paper clips, and staples
- Avoid dropping the unit
- When finished be sure there are no bills in the hopper or transport system
- When not using the unit for an extended period of time, disconnect the power cord from the wall outlet
- Unplug the unit from the wall outlet before cleaning. Use a damp cloth or specifically designed maintenance accessories such as an air duster, soft bristle brush, or cleaning cards.
- To avoid the risk of electrical shock, do not disassemble this unit. Disassembly will expose you to dangerous voltages and other safety risks. Incorrect reassembly can cause electrical shock when the appliance is subsequently used.
- Clean the unit regularly
- Take the unit to a qualified technician when service or repair is required. Do not try to replace any parts yourself. Supplied spare parts are intended for use by qualified repair personnel only.

Remember the manufacturer is in no way responsible for damage to the unit or injury to the operator in the event of incorrect operation/care of the unit.

2. GETTING STARTED

2.1 Open the stacker assembly

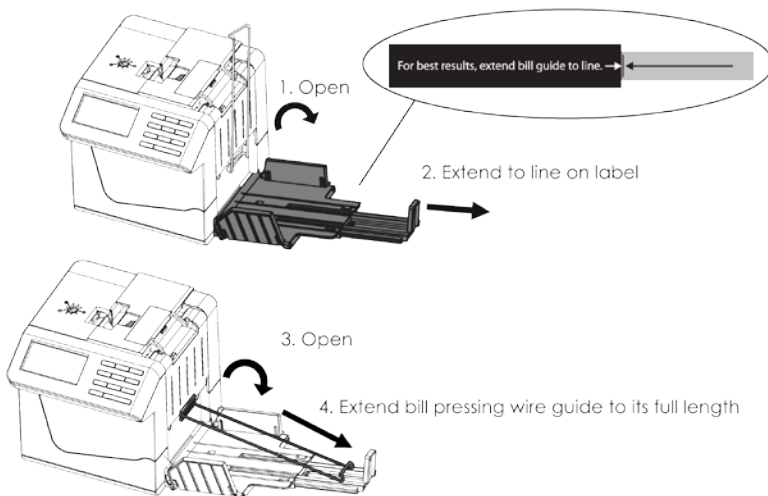

NOTE: For optimal counting of US currency, the hopper guide should extend no farther than 16.5 cm (approximately 6.5 inches) from the edge of the Cube. The bill pressing wire should be extended to its full length. Please follow guidelines shown on the affixed stickers.

2.2 Open and adjust the hopper



2.3 Open tilt stand

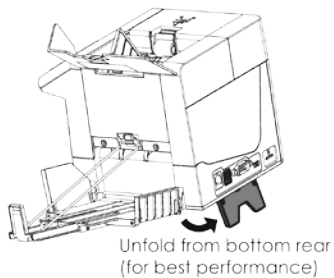

2.4 Connect the power source

There are two types of power source can be connected to the counter:

- The AC/DC power adapter: convenient for indoor use
- The battery: convenient for portable use

2.5 Install the battery

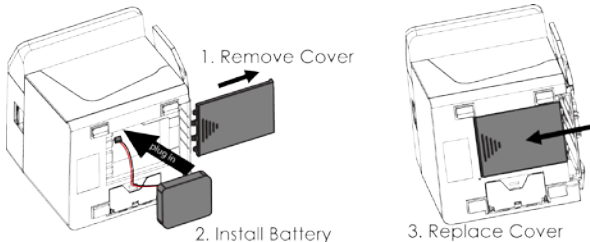

Before first use, the rechargeable battery should be installed

- When the counter connects to the external power supply, it will be charged automatically. The battery status symbol is displayed on the upper right corner of the LCD. A solid symbol means the battery is full and an empty symbol means the battery is insufficient. If the symbol is flashing and changing from solid to empty, it means the battery is being charged. When the battery is poor, "Low battery" will be displayed. It means the battery is too low, you should stop counting and charge the device.

- The battery status symbol will not be displayed on-screen if a battery is not connected.

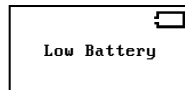

- If the device works on a battery, then in working mode, when the counter idles up to 20 minutes, it will turn off automatically.

3. LOADING BILLS

Place the machine on a flat surface, then open the tilt stand, ensuring that no strong electromagnetic fields, bright light or sunshine are contacting the Cube. Plug the electric socket into AC electric source. If you have purchased an external display, connect it to the external display interface on the back of the counter.

Press  for 2 seconds, machine will perform a self-test (see Figure 3-1).

If the self-test is successful, the machine will enter into ready state (see Figure 3-2), if some error messages are displayed, please deal with them according to the Troubleshooting in the manual. See section 6.

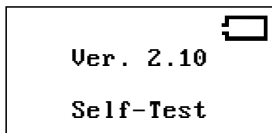

Figure 3-1

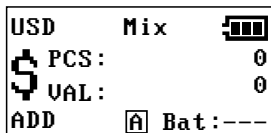
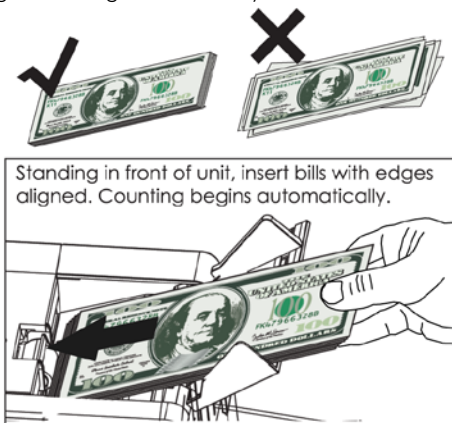

Figure 3-2

It is very important to place the bills into the hopper correctly, because recognition performance of the bills is highly affected by the arrangement of the bills. Bills should be placed in a neat stack prior to being placed into the hopper. Please avoid counting bills that are wet, excessively dirty, spoiled, folded, curled or with foreign material like clips, bands, etc. It will damage and cause malfunction of the machine.

Arrange a stack of bills with smaller denominations in the middle, where possible. Then set the hopper guide to the position where it just touches the edges of the bills. While standing in front of the Cube, lay the bills flatly on the hopper. The Cube will begin counting automatically.



When a suspicious bill is detected, the counter will stop immediately and the machine will emit a beep. The top bill in the stacker is a suspect bill. Remove the top bill, press **START** and the machine will continue counting.

NOTE: Certain errors, such as double notes, chain notes and passing errors will cause the Cube to stop automatically. If this occurs, please recount all bills in the stack

4. OPERATION

4.1 Select Auto/Manual mode

To switch between Auto (A) and Manual (M) start modes, enter setting menu by pressing **MENU**, then **CUR**, then press **ADD** to select Auto mode ON or OFF. To confirm and leave the settings menu, press **MENU**.

In Auto mode "A" will be displayed on the screen. The machine starts counting automatically, when the bills are placed into the hopper.

In Manual mode "M" will be displayed on the screen. The machine starts counting, when the user presses **START**.

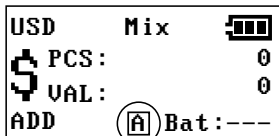

Auto mode

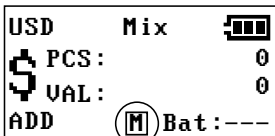

Manual mode

4.2 Select counting mode

A. Piece Count Mode

This mode is used to count the total number of bills. To start this mode, select "Piece Count" by pressing **CUR**.

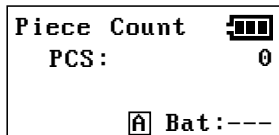

B. Mixed Count Mode

To start MIXED mode, select "MIX" by pressing **MODE**. This mode is used to count a stack of mixed denominations. Total number (PCS) and total value (VAL) will be displayed on the screen. When operation is complete, press **REP** and the detailed report will be displayed on the screen. Press **REP** once again to return to the main screen.

C. Sort Count Mode

To start SORT mode, select "Sort" by pressing **MODE**. This mode is used to count and sort bills by one denomination which is automatically determined by the first passing bill. The first bill in the hopper determines the sorting denomination. If the denomination on the second or other bills in the stack differs from the first bill, the machine will stop and alert the user with a DENOMINATION DIFFERENT warning. Once the bill with the different denomination is removed from the stacker, press **START** to resume the operation. Total number (PCS) and total value (VAL) will be displayed on the screen. When operation is complete, press **REP** and the detailed report will be displayed on the screen. Press **REP** once again to return to the main screen.

In Mix and Sort modes, after counting is complete, the machine will provide a report of all counted bills when **REP** is pressed. The detailed report will be displayed on the screen as follows:

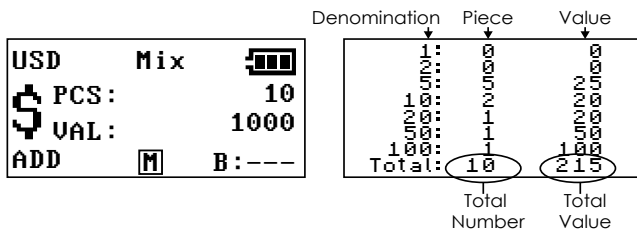

Press any key to exit the report mode automatically. Press **CLR** to clear the count memory.

4.3 Printing function

To connect the Cube to a printer, follow the diagram as shown. The Cassida Cube has a special print cable that is included with your unit.

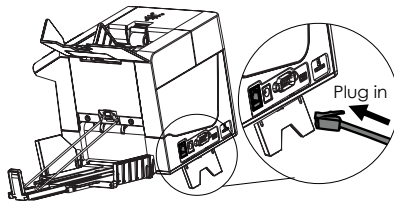

When the Cube is connected to a printer, power on the Cube first, then turn on the printer, to assure connectivity.

If the printer is connected to the machine, press and hold **PRT**, "Print..." will be displayed on the LCD as shown below and the report will be printed. After printing is completed, the Cube returns to its ready state.

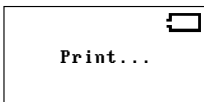

4.4 Select ADD function

When you need to get an accumulative total of what you're counting, use this function. Press **ADD** and "ADD" will be displayed on the lower left side of the screen. NOTE: Activating ADD zeros out and resets any piece count and value on screen.

Place bills in the hopper and press **START** to begin counting. The piece count and value will display on screen (see figure 4-1). Add an additional stack of bills to the hopper and the piece count of the bills and value of the bills will be added to the previous count just finished. With ADD activated, the number displayed on screen is the sum total of several counts (see figure 4-2).

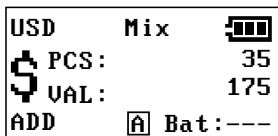

Figure 4-1

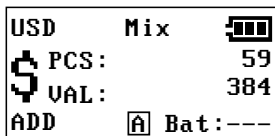
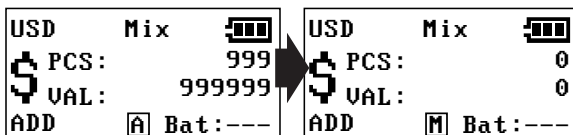

Figure 4-2

When the piece count reaches 999+1 or the accumulative value reaches 999999+1, the count and value revert to zero.



4.5 Select batch counting

To select a batch amount, press **BAT**. When "100" is displayed on the preset window, it shows the batch function has been turned on. Each time you press **BAT**, 100, 50, 25, 20, and 10 will be displayed in turn. If the LCD displays "----", the batch function is disabled. You also can press or hold **+1/+10** to increase the batch number by 1 or 10. The batch number can be selected in the range of 1~200. After setting the batch number, load bills on the hopper and begin counting. When the unit reaches its batch number, the machine will stop automatically so the batched bills may be removed from the stacker. To turn off batch counting, press **CLR**.

Note: Batch counting applies to the number of bills, not the amount.

5. SLEEP AND TIME SETTINGS

To adjust the time settings, enter the Settings menu by pressing **MENU** .

```
Time Set
Auto      :   ON
Sleep Time : 10M
To Select :  CUR
To Change :  ADD
```

Time Set: Setting time
Auto: Setting Auto/Manual mode
Sleep Time: Setting sleep time (5 minutes, 10 minutes or off)

Changing the set time:

Press **CUR** to select the desired option.

Press **ADD** to change the parameter.

Press **CUR** to select the option to be modified. Press **ADD** (+) and

MODE (-) to increase or decrease the parameter's value.

Press **MENU** to save the change and exit.

6. TROUBLESHOOTING

6.1 Self-test error message display and solutions

The machine performs a self-test automatically after powering on. If one of the following error messages is displayed on the LCD, usually it is because the sensor is blocked by debris, or a jammed bill or. Please use a brush compressed air to remove dust from the sensor. Remove any jammed bills and restart the machine.

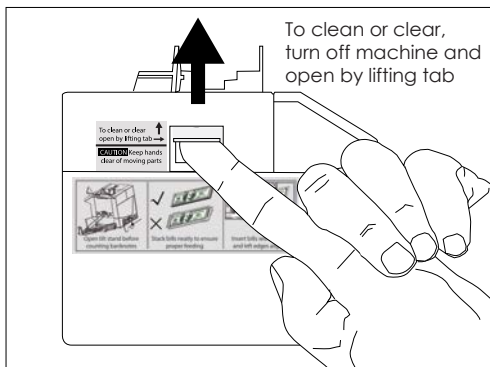

ERROR MESSAGE DISPLAY	SOLUTION
PassA counting sensor PassB counting sensor PassC counting sensor PassD counting sensor	Remove all bills and clean the counting sensor.
Upper IRA sensor Upper IRB sensor Upper IRC sensor Upper IRD sensor Lower IRD sensor Lower IRF sensor Lower IRG sensor Lower IRH sensor Upper color sensor Lower color sensor Upper spectrum sensor Lower spectrum sensor	Remove all bills and clean any sensors.
Banknote feeding sensor	Remove all bills and clean the hopper assembly.
Magnetic A sensor Magnetic B sensor Magnetic C sensor Magnetic D sensor	Remove all bills and clean the magnetic sensor
Internal memory fault	Reset unit to factory settings by holding both  and MENU while the unit is off. After a self test, "Set default parameter" will display. The unit will return to its normal state within seconds.
Rotate speed sensor	Clean the encoder wheel and sensor, or replace the drive belt. This will need to be done by a trained specialist. See section 7.4 for contacting a Cassida service provider.

6.2 Defective bill error message display and solutions

If any of the following error messages are displayed during counting, use the following solutions to correct the problems after the machine has stopped.

ERROR MESSAGE DISPLAY	SOLUTION
Incomplete notes	Half or incomplete bill. Remove the bill from the stacker and press START to continue counting
Magnetic feature fail IR error UV error Image error Paper error Spectrum error Suspect bill MG erro Suspect bill IR error Suspect bill UV error Suspect bill Image error Suspect bill Paper error Suspect bill Spectrum error	Counterfeit or suspicious bill. Remove the bill from the stacker and press START to continue counting.
Denomination different	Remove the bill from the stacker and press START to continue counting.
Slant notes	Bill tilt. Press START to continue counting. If it occurs frequently, adjust the adjusting screw toward the counter-clockwise direction.
Double notes Chained notes	Some bills are stuck together or overlapped. Remove all bills and recount. If these errors occur frequently, adjust the adjusting screw slightly clockwise.
Passing error	Press START . Open the bill transport path to remove the bill and recount all bills.

7. MAINTENANCE, WARRANTY AND CONTACT INFO

7.1 Maintenance

Regular maintenance will ensure accurate operation of the unit, and will prolong its service life. Keep the counter in a ventilated place and away from direct sunshine and strong magnetic fields. Periodically clean all sensors using a soft brush or compressed air. Keep the surface of sensors away from sharp and hard articles to avoid damage.

ATTENTION: The Cassida Cube should be cleaned frequently to keep it performing properly. We suggest opening the unit and using a can of compressed air to remove dust from interior spaces. Be certain to avoid contact between the nozzle and any surfaces, to assure no damage occurs to sensors.

Cassida can service your Cube, if necessary, even if the repair is not covered under than warranty. To get a maintenance or service quote, please log on to Cassidausa.com/support and fill out a support form.

7.2 Warranty

Our goal is to make Cassida your lifetime work partner. That's why Cassida products are subject to stringent quality control measures and are backed by a solid one year parts and labor warranty.

To activate your warranty in the US or Canada, please register your product online by visiting www.cassidausa.com/register.html.

In many cases a unit malfunction can easily be corrected by performing a thorough cleaning. This requires disassembly of the unit to clean each individual sensor. This cleaning is not covered by warranty and should be performed only by your local dealer or the Cassida Technical Service Center.

Cassida is happy to service your Cube even if it is not covered under warranty. To request service please log on Cassidausa.com/service and fill out a form requesting service.

7.3 Shipping

The warranty does not cover the cost of shipping to Cassida's Technical Service Center.

7.4 Contact information

Technical support contact information:

www.cassidausa.com/support.html

www.cassidausa.com



care about
money



speed



counterfeit
detection



operation
ease



design



support



quality

Cassida Corporation - North America

Printed in China

2015 Cassida Corporation. All rights reserved.

Specifications subject to change without notice. Cassida is a registered trademark of Cassida Corporation.

FN CubeREV 0116