

FITTING AND OPERATING INSTRUCTIONS

DOMINO 1100 RC

DOMINO 1XXX, other versions

Radar motion sensors for the detection of objects for automatic gates.

SAFETY INFORMATION



The unit is only to be operated with voltages that comply with the Safety Extra-Low Voltage (SELV) requirements in safety standards based on IEC 60950. This unit is only to be installed and maintained by trained, qualified personnel.

1. FITTING

1.1 OPENING THE RADAR SENSOR UNIT

from the rear, prior to installation

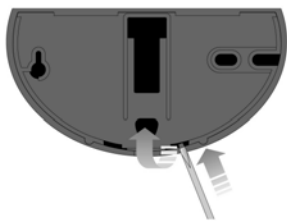

from the front, after installation

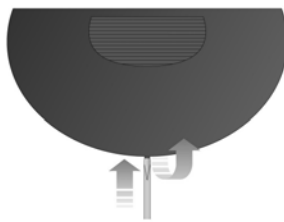

1.2 DRILLING

Stick the drilling template in place and drill according to the instructions

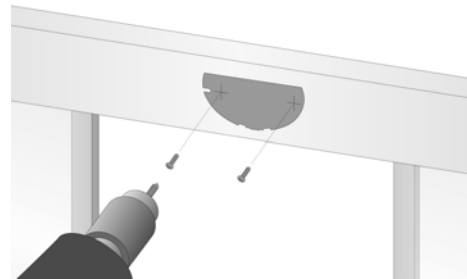

1.3 FASTENING AND CONNECTING-UP

Draw the cable through the opening provided

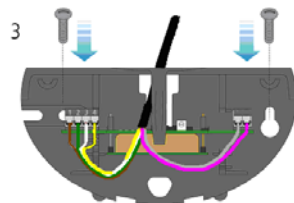
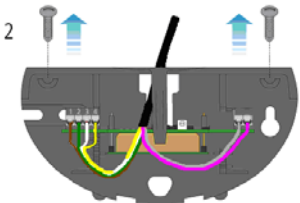
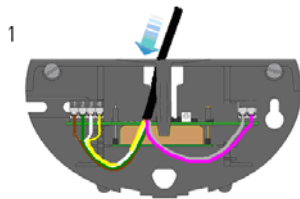

Connect the cable to the terminals

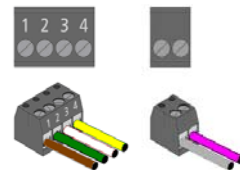

- | | |
|----------------------|--------|
| 1 power supply AC/DC | brown |
| 2 power supply AC/DC | green |
| 3 Main relay | white |
| 4 Main relay | yellow |
| Vehicle relay | grey |
| Vehicle relay | pink |

Fasten the base plate with the screws contained in the housing, to remove and insert the electronics, observe the instructions in point 2.3

1.4 OTHER INSTALLATION OPTIONS

Optional accessory out of the 4tec accessory range.



Ceiling-mounting with mounting bracket

or

Wall fastening with weather-cap set



1.5 SETTING UP THE RADAR SENSOR

1. Switch on the unit and wait 10 seconds (LED flashes red/green)
2. Adjust the radar sensor unit / Check the setting by pacing out the distance

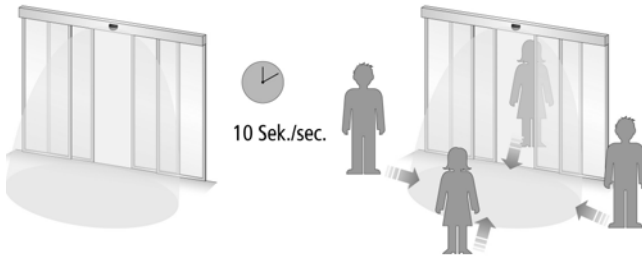

1.6 CLOSING THE RADAR SENSOR UNIT

Insert the cover from the top and press until it clicks in place

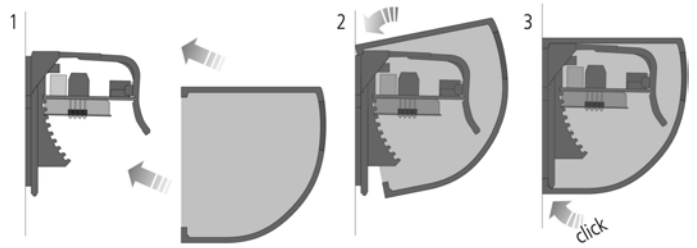

2. SETTINGS

2.1 OPERATING ELEMENTS

- 1) Antenna
- 2) IR-receiver
- 3) IR-transmitter
- 4) Main relay
- 5) Terminal (power supply/main relay)
- 6) Vehicle relay
- 7) Terminal (vehicle relay)
- 8) Button/Menu
- 9) Button/Value
- 10) LED

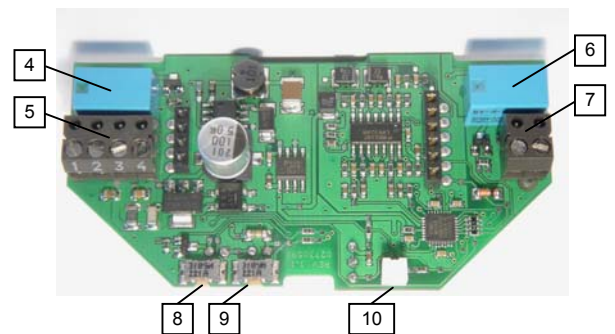
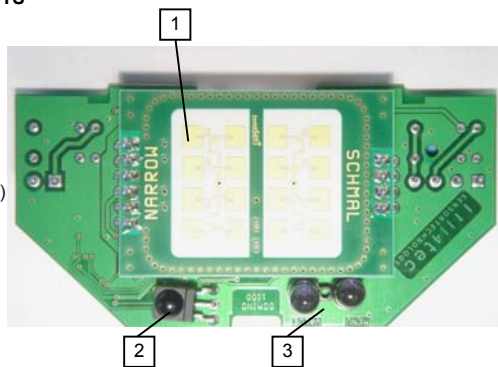

2.2 DIMENSIONS OF THE DETECTION AREA

Settings: Detection area angle 30° and sensitivity max. VALUE 16

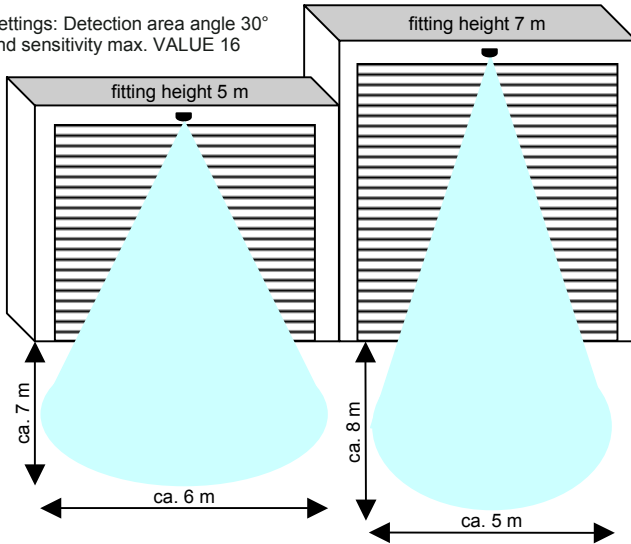

2.3 CHOICE AND EXCHANGE OF ANTENNA

Optional out of the 4tec accessory range.

Changing the antenna allows to realise different characteristics of the detection area.

To change the antenna, withdraw it carefully with two fingers and then insert the new antenna.



Do not use any metallic tools!



Static sensitive devices.

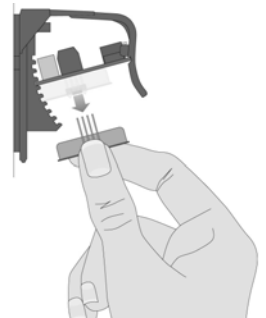

2.4 POSITION OF THE DETECTION AREA

To make an adjustment, take hold of the printed circuit board by the edge, pull it forward, and then place it in the desired position.

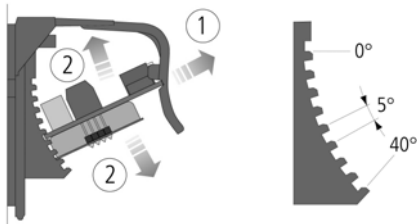

The position can be adjusted in 5° steps from 0° to 40°. The factory setting is 15°, notches can be broken out.

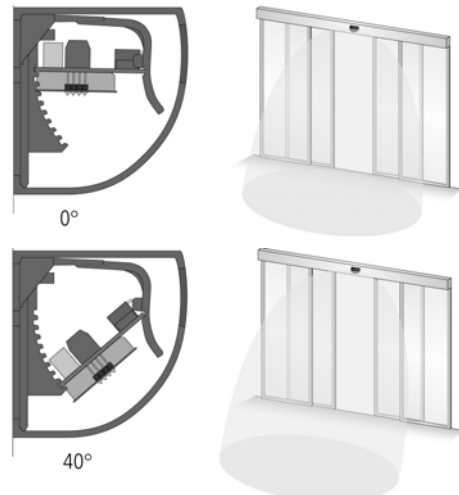

The printed circuit board can also be inserted at a slant angle.



Turn maximum 3 steps to the right or to the left!

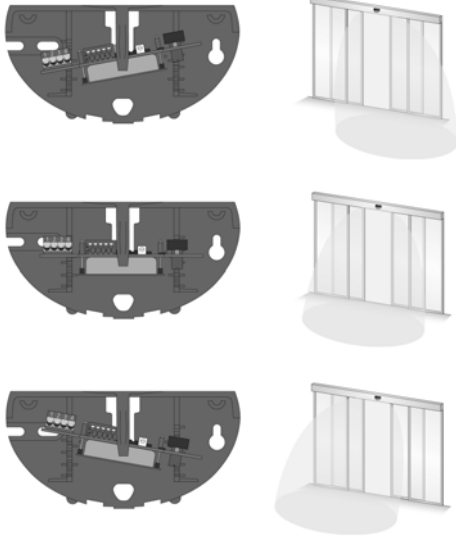

2.5 SIZE OF THE DETECTION AREA / SENSITIVITY

The sensitivity potentiometer control enables the size of the detection area to be adjusted.



high sensitivity = big detection area
low sensitivity = small detection area

2.6 DESCRIPTION OF THE DIFFERENT CONFIGURATION CHARACTERISTICS OF THE RADAR SENSOR UNIT

Detection characteristics

without direction recognition (mono)

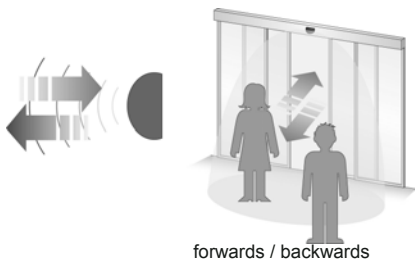

forwards / backwards

with direction recognition (stereo)

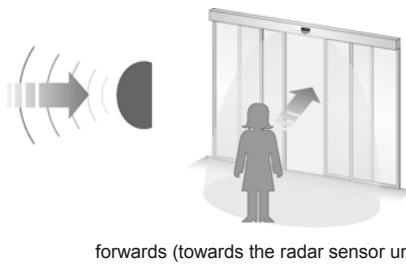

forwards (towards the radar sensor unit)

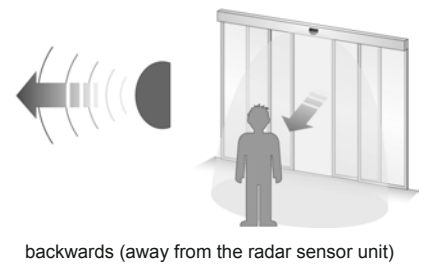

backwards (away from the radar sensor unit)

The direction recognition can completely be switched off. The radar sensor unit will not detect any movements and if the relay contact will be changed now the gate remains constant open or closed.

Cross traffic fade-out

Settings selectively: low, medium or high

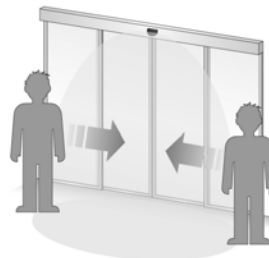
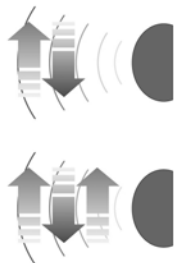

especially suited to fitting angles of 25° to 40°

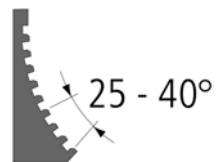

If the cross traffic fade-out function is switched on, the gate will open only if the motion is towards the gate.

People- vehicle detection

The radar is able to analyse motions from people or vehicles different and to switch, according to the settings, the main relay, the vehicle relay or both relay at the same time.

Relay functions

The **main relay** switches always, that means for people and vehicles detection.

The **vehicle relay** switches only if the vehicle detection is activated and a vehicle will move inside the detection area.

Examples of use

Gate with separate pedestrian door. Gate control unit with 1 input.
Vehicle detection activated, only the vehicle relay is connected to the Gate control unit

Vehicle approaches, vehicle relay switches, (LED fast flashing green/red) gate opens

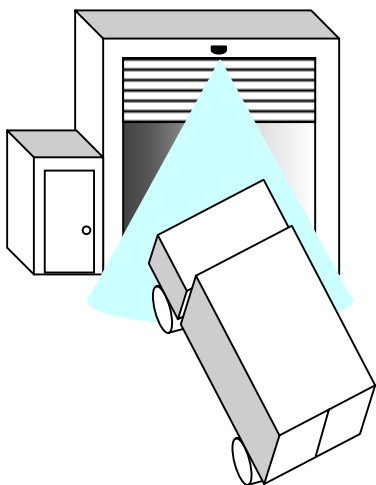

Person approaches, vehicle relay switches not, Gate remains closed, person uses the pedestrian door

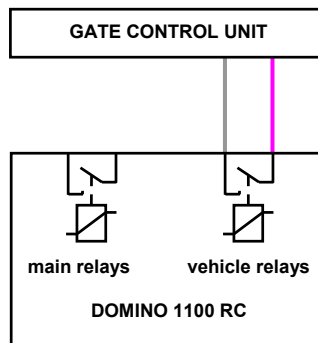
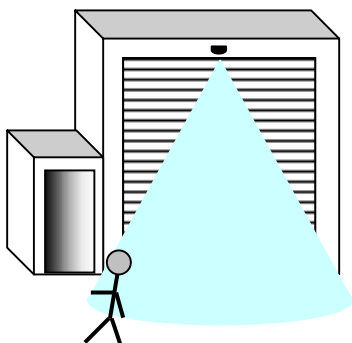

Gate without separate pedestrian door. Gate control unit with 2 inputs.
Vehicle detection activated, vehicle relay and main relay are connected to the Gate control unit

Person approaches, main relay switches, (LED lights red) gate opens half

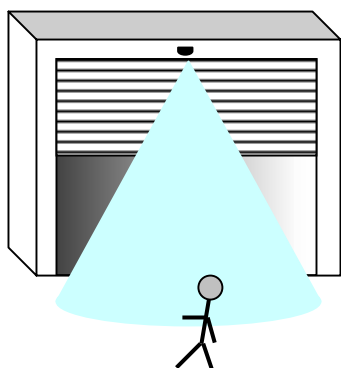

Vehicle approaches, vehicle relay switches, (LED fast flashing green/red) gate opens completely

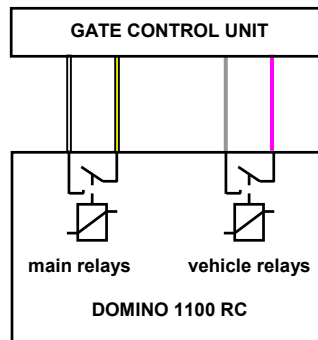
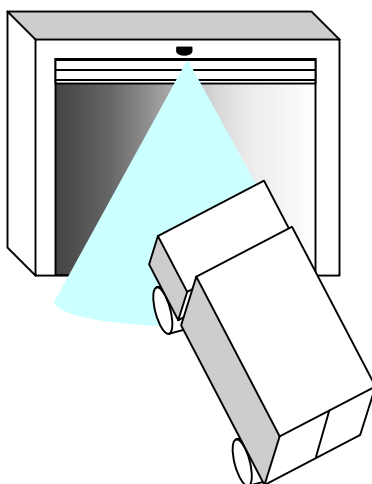

2.7 LED STATUS DISPLAY



LED

- green
- red
- green/red fast flashing
- green/red slow flashing
- green flashing
- red flashing

- unit ready for operation
- main relay active
- vehicle relay active
- initialisation (for 10 seconds after switching on)
- command received
- error

SETTINGS WITH REMOTE CONTROL Domi-LINK

The Domi-LINK allows to set the radar sensor unit easy, fast and perfectly from the floor. While the programming the sensor functions are still active. The settings can be checked immediately.



Low batteries (shown on the Domi-LINK display), sunlight, fluorescent lamps and wrong orientation of Domi-LINK can reduce the range and cause transmission errors.
For safety reasons the IR-programming mode will be intermitted after 30 min., alternatively completely blocked.
To unlock the programming mode, push the MENU or VALUE button at the radar sensor unit or cut the power supply for a few seconds.

Establish connection

Before starting the programming please read the Domi-LINK operating instructions!

Sensor switched of and ready for operation, LED is green.

Domi-LINK must point frontal at the sensor.

For a perfect transmission the sensor angle (0 – 40°) should also be considered.

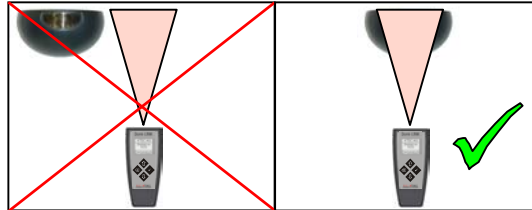

Choose the Domino 110X RC from the sensor list shown at the Domi-LINK LCD-display. After that select the address, only necessary if more than one sensor is inside the range of Domi-LINK. Programming the address → have a look at the settings with buttons. The address can be selected from the list or can be read out with "search address". The mark show the selected address.

Push the select button  to establish a connection to the radar sensor unit. If the connection is established, on LCD display will be shown a list with all settings. The mark shows the current settings.

If the sensor is encoded, the display will show "enter code". The code can be set with the for Domi-LINK push buttons.

As soon as the fourth digit has been set the code will be transmitted. If the code is correct a selection list will appear on display.

Start settings

The four push buttons allow to select the desired settings shown on display.

With "read value" the current setting can be read out and shown on display. The required value can be selected with the arrow push buttons and confirmed and transmitted with pushing the select button. The mark shows immediately the new value. If the transmission was not OK the error will appear on display and the transmission has to be repeated. The new setting can be read out immediately after the transmission.

Sensor list
Domino 100X RC
Domino 101X RC
Domino 102X RC
Domino 110X RC
Domino 110X RC
search address
address 1
address 2
address 3
address 4
enter code

Domino 110X RC
Sensitivity
Detection mode
Vehicle detection
Output hold time
Relays contact
Fade out cross traffic
Sensitivity
read value
1 min
2
3
4

Programming table Domi-LINK

MENU	SETTINGS	DESCRIPTION
Sensitivity	1 – 16	1 = lowest sensitivity = small detection area 16 = highest sensitivity = big detection area
Detection mode	off stereo forwards stereo backwards mono	off = no detection possible detects motion towards the radar sensor unit detects motion away from the radar sensor unit detects motion forwards and backwards
Vehicle detection	off low medium high	off = no detection the vehicle relays does not switch only vehicles will be detected the settings low, medium and high allow to set the sensor accurate according to the localization
Output hold time	off 0.2s 0.5s 1.0s 1.5s 2.0s 3.0s 4.0s 5.0s	off = relay does not switch 0.2s = smallest hold time 1.0s = factory setting 5.0s = biggest hold time
Relay contact	N.O. N.C.	contact will close by detection contact will open by detection detection mode switched off and the change of relay contact will keep the gate constant open or closed
Fade out cross traffic	off low medium high	all movements well be detected cross traffic will be fade out the settings low, medium and high allow to set the sensor accurate according to the localization
Reset		put all values back on factory setting
Code	access with code * lock access access without code	set an access code code and programming mode will be locked immediately, new access not possible anymore* code will be deleted, programming mode is free access to programming mode only with code possible access to programming mode without code possible
Disconnect		leave programming mode, access is encoded, decoded or locked immediately, according to setting

* lock access

If you lock access, the programming mode will be locked immediately. The radar sensor unit will not accept any commands from the remote control. To unlock the programming mode, push the MENU or VALUE button at the radar sensor unit or cut the power supply for a few seconds.

3. DISTURBING INFLUENCES / INSTALLATION RECOMMENDATIONS

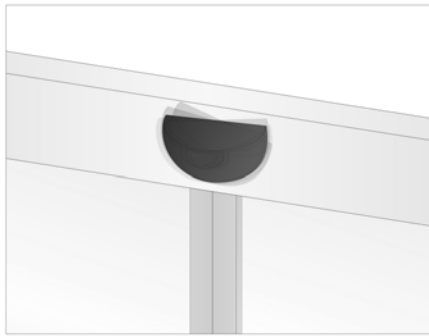

The radar sensor unit must be installed on a firm surface. It must not be subject to vibration.

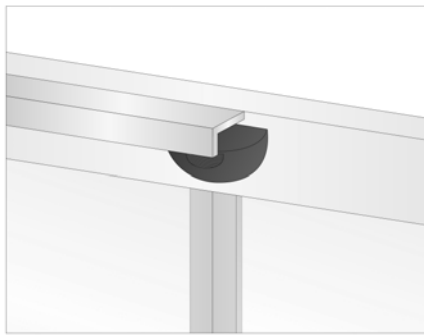

The radar sensor unit must not be installed behind a panel or other cover.



No moving objects (e.g. fans, plants, trees, flags, etc.) are permitted in the detection area of the radar sensor unit.



The radar sensor unit should be installed in a position where it is protected from rain.



In this case the installation of a weather-cap out of the 4tec accessory range would be recommended.



The radar sensor unit should not be fitted close to fluorescent lamps.

4. FAULT RECTIFICATION

Gate sees itself → reduce sensitivity, position radar sensor unit further forwards
 LED fails to illuminate → no current, unit defective

5. SCOPE OF DELIVERY

- Domino 1100
- connecting cable
- fitting screws
- self-adhesive drilling template

6. OPTIONAL ACCESSORIES

- Domi-LINK (remote control)
- ceiling-mounting bracket
- weather-cap set (ceiling-mounting bracket included)

7. TECHNICAL DATA

Supply voltage	12-36 V DC / 12-28 V AC	Temperature range	-20°C to +60°C / -4°F to +140°F
Current consumption approx.	ca. 50 mA @ 24 V DC, 20°C	Atmospheric humidity	0 to 90 % RH, non-condensing
Power	< 1 W	Protection class	IP54
Microwave module	K-band 24.05 GHz–24.25 GHz	Housing material	Ground plate ABS, cover Polycarbonate
Transmitting power	< 20 dBm	Dimensions	123 mm (W) x 65 mm (H) x 57 mm (D)
2 Relay outputs	NO or NC	Weight	120 g
Nominal power	0.5 A 120 V AC / 1 A 24 V DC	max. installation height	7 m
max. breaking capacity	24 W / 60 VA	Electromagnetic compatibility	CE in accordance with EMC directive 89/336/EEC
max. breaking voltage	120 V AC / 60 V DC	min. detection speed	0.1 m/s
max. switching current	1 A	Approval	CETECOM, test report no.: 2-3279-01-01/03
Stop period	0.2 s – 5 s	Quality	Made in Switzerland

This unit complies with the requirements of the European R&TTE directive.

CE0682