

## TECHNICAL INFORMATION

### Description

The Sure Grip "SU" Series Control Grip is a low cost compact handle designed for simple applications that require few switches.

The "SU" handle is configurable with all the Sure Grip Handle Options such as; slider modules, rocker modules, micro joystick, LED's, toggle switches and more. It also offers accessories such as bushing adapters, studs, sealed connectors and more. (Please refer to Handle Accessories on our website.)

The cases are molded from a high impact plastic polymer into a comfortable shape for a rugged and lightweight control handle for extreme duty applications. The standard Sure Grip switches are covered with our patented overlay design.

Standard configurations are available for next day shipping (please contact factory for details).



### Features

- ▶ Sealing up to IP67
- ▶ Rugged design
- ▶ Overlay customizable
- ▶ Switch tested to 10 million operations
- ▶ Multiple trigger options available
- ▶ Supports 1 Microjoystick
- ▶ Supports 1 Slider or Rocker Module
- ▶ Supports up to 2 faceplate switches

## TECHNICAL INFORMATION

### MOMENTARY SWITCH SPECIFICATIONS

Switch Options:	Load	Voltage	Operating Temp
Unsealed Standard - IP40	3 A	30 Vdc	-25°C to +85°C
Sealed Switch - IP67	1 A	30 Vdc	-40°C to +85°C
Unsealed Gold contact - IP40	100 mA	30 Vdc	-25°C to +85°C
Sealed Gold Switch - IP67	100 mA	30 Vdc	-40°C to +85°C

### MAINTAINED SWITCH SPECIFICATIONS

Switch Options:	Load	Voltage	Operating Temp
Push Button	3 A	30 Vdc	-30°C to +85°C

### TOGGLE SWITCH SPECIFICATIONS

Switch Options:	Load	Voltage	Operating Temp
Toggle Switches	3 A	30 Vdc	-30°C to +85°C
Functions	On-On / On-Off-On / Mom-Off-Mom / On-Off-Mom		

### LED SPECIFICATIONS

LED Options:	Load	Voltage	Operating Temp
LED	20 mA	5, 12, 24 Vdc	-40°C to +85°C
Colours Available	Red / Green / Tri-colour (R/Y/G)		

### CABLE SPECIFICATIONS

Cable Options:	WR-09B	WR-10B	WR-13B	WR-15B
Conductor	9	10	13	15
Material	Tinned Copper	Tinned Copper	Tinned Copper	Tinned Copper
Strand	19 Twisted	7 Twisted	19 Twisted	7 Twisted
AWG	20	22	22	22
Insulation	SR-PVC	SR-PVC	SR-PVC	SR-PVC
Outer Jacket	PVC FT4	PVC FT4	PVC FT4	PVC FT4
Operating Temperature	-40°C to +105°C	-40°C to +105°C	-40°C to +105°C	-40°C to +105°C

## TECHNICAL INFORMATION

### Dimensions

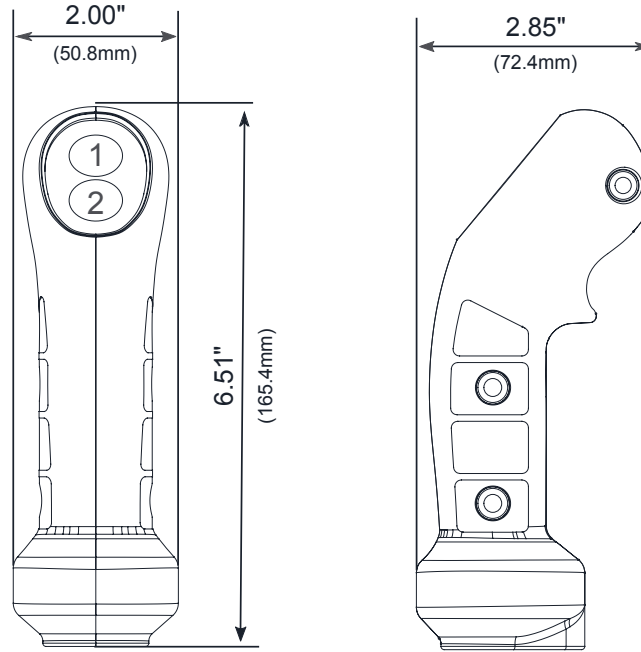

### Typical Wiring

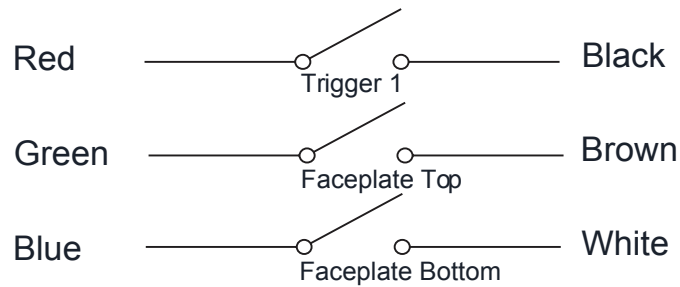

## ORDERING GUIDE

### Order Instructions:

- Each box has a color and number, which corresponds to handle options below. Please review each option, as this will help you with choosing your part number. (Refer to our technical guides for more information on product options)
- If a desired handle option is not available contact a sales representative to discuss if there are alternative solutions for your application.
- Enter your configured part number in the empty boxes provided below and contact a friendly Sure Grip sales representative to place your order.







Your configured part number: **SU** -    -    -    -    -    -    -    -    -    -   

1      2      3      4      4      5      6      7      8      9      9

Example: **SU** - B - B - SN - A - F - B - N - N - 000 - B - E

P1      P2

\*Faceplate Location Reference

1. Handle Color	
B - Black G - Grey	
2. Switch Style	
N - No Switch A - UnSealed 3Amp Switch B - Sealed 1Amp Switch C - Unsealed 100mA Switch D - Sealed 100mA Switch	
3. Trigger Options	
NN - None SN - Single PN - Proportional	
4. Function Types	
N - None	Mo - Momentary
1 Position	Ma - Maintained
A - Mo Switch	F - Friction
*B - Ma Switch	 Slider
*C - Toggle 2Ma	 Rocker
*D - Toggle 3Ma	 Micro Joystick
*E - Toggle 3Mo	 Micro Joystick
*F - LED Red	 Micro Joystick
*G - LED Green	 Micro Joystick
*H - LED Bi-Colour (R/G)	 Micro Joystick
2 Positions	
J - Proportional Slider 3Mo	
K - Proportional Slider 3Ma	
L - Proportional Slider F	
U - Proportional Slider 1Mo	
M - Switched Rocker 3Mo	
P - Switched Rocker 2Ma	
Q - Switched Rocker 3Ma	
R - Switched Rocker MaMo	
S - Proportional Rocker 3Mo	
T - Proportional Rocker 3Ma	
4 Positions	
V - Micro Joystick	
Z - Multi position designator	(See example below)
*Refer to handle options on website for more information	

5. Mounting Options
N - None or JSM/JSL installed
<u>Mounting Bushing</u>
A - Adapter Bushing - 1/4" Hole
B - Adapter Bushing - 10mm x 1.5
C - Adapter Bushing - 10mm Set Screws
D - Adapter Bushing - 12mm x 1.25
E - Adapter Bushing - 12mm x 1.5
F - Adapter Bushing - 12mm x 1.75
G - Adapter Bushing - 14mm x 2
H - Adapter Bushing - 5/8" NC
J - Adapter Bushing - 14mm x 1.5
K - Adapter Bushing - 3/8" NC
L - Adapter Bushing - 1/2" NC
M - Adapter Bushing - 9/16" NC
<u>Clamping</u>
P - Clamping Bushing 12mm
Q - Clamping Bushing 14mm
6. Mounting Studs
N - None or JSM/JSL installed
R - 12mm x 1.75 x 40mm socket Set Screw
S - 10mm x 1.5 x 40mm Straight Stud
T - 9/16" x 75mm wire exit, Straight Stud
U - 14mm x 2 x 50mm Bend Stud @ 22 degrees
V - 14mm x 2 Bend Stud @ 28 degrees
W - 12mm x 1.75 x 40mm, Bent Stud
X - 12mm x 1.75 x 70mm, Drilled Bent Stud
Y - 5/8" NC - 14mm x 85mm wire exit, Bent Stud
Z - 14mm x 2.0 x 40mm Straight Stud
7. Boot Mounting
N - None
S - Square
R - Round

8. Wire Length Options
xxx Inches
9. Electronics #1 and #2
N - None
A - Dual Danfoss DA2
B - Caterpillar Interface DA2C2
C - Diode - Diverter Protection DPd
D - Power Supply PS5 5VDC
E - Single Driver Board SDB
*Refer to Control Electronics on website for more information

\*Faceplate Location Reference

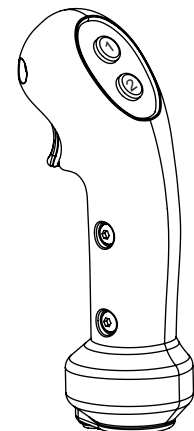

**Comment Section**

## EXAMPLE GUIDE

**SU Example 1**

**SU-G-A-SN-AA-A-N-N-120-N-N**

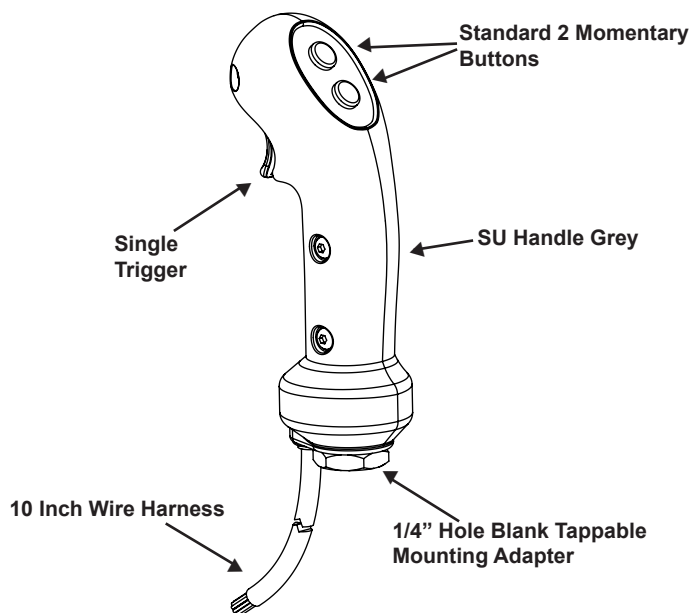

**SU Example 2**

**SU-B-B-SN-FA-B-N-N-024-N-N**

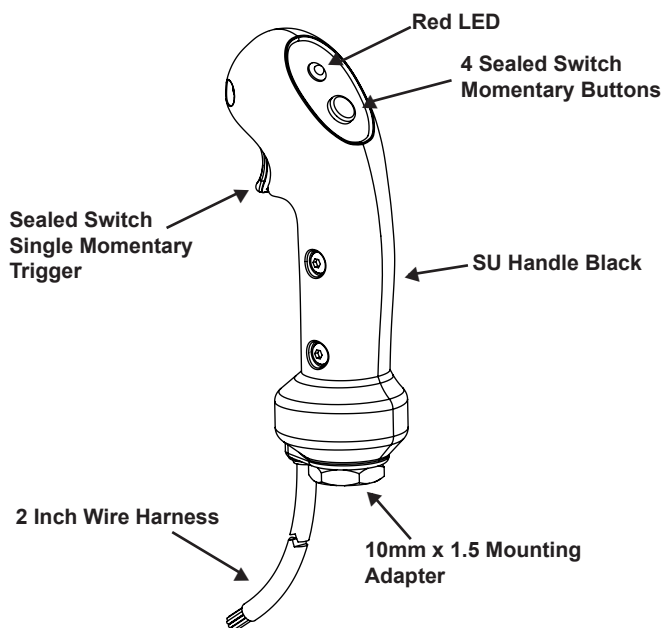

**SU Example 3**

**SU-B-N-NN-JZ-N-N-N-144-E-N**

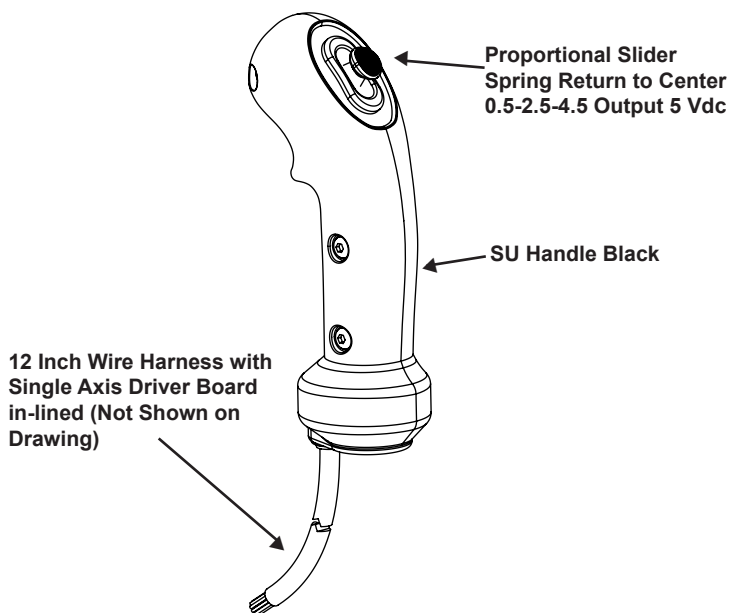

**SU Example 4**

**SU-B-A-SN-QZ-Q-N-N-060-C-N**

