

MERAK

MANUAL

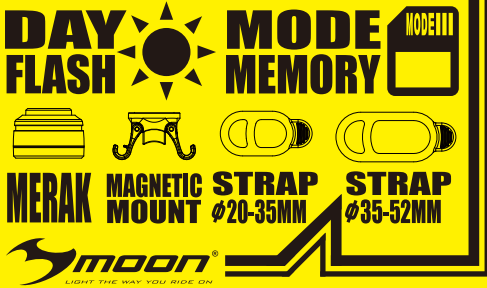

Read this manual carefully before using and keep for future reference. Visit www.moon-sport.com for manual updates.

CONTENTS

- MERAK
- Magnetic mount RB-29-R
- 2 CR2032 batteries
- Straps
 - RS-G for \varnothing 20-35mm
 - RS-H for \varnothing 35-52mm

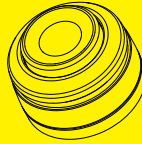

RUNTIME

	Mode 1	Mode 2	FL1	FL2	DAY FL
LUMEN	3	6	3	8	15
H:MIN	45:00	35:00	100:00	40:00	60:00
1M LUX	11	21.5	-	-	/
2M LUX	2.8	5.2	-	-	/



INITIAL USE

Twist the bottom case cover clockwise to open. Take away the insulation sheet before use.

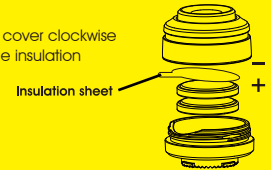

BATTERY INSTALLATION

Twist the bottom case cover clockwise to open. Place batteries as shown in fig.

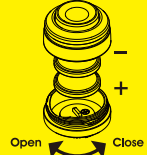

To replace batteries, use the magnet on the bottom case cover to extract the batteries out.



MOUNTING

Attach strap to one bracket hook.
Pull strap over the post and attach to hook.
Place light on bracket, twist clockwise into the groove.

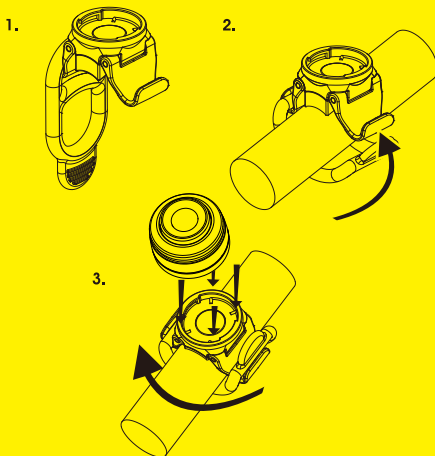

OPERATION

1. Press to power on.

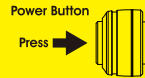

2. Press to choose modes in cycle.

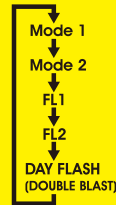

3. Press 1 sec to power off.

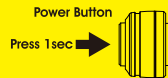

**With Mode Memory Function:
the light resumes previous mode upon next usage.

AUTO SAFE MODE

To preserve battery when power is low, the light will enter low output flashing mode for 1hr. Safe mode cannot be override. Replace the batteries for maximum performance.

WARNING

- * Understand country lighting laws and regulations before use.
- * Do not shine directly in the eyes.
- * Do not submerge the battery or the whole light into water.
- * Do not dismantle the light which will void warranty.
- * Do not leave the light on and unattended.
- * Keep the light away from fire and combustible materials.

WARRANTY

MOON Lights are covered by a ONE YEAR LIMITED WARRANTY from the date of purchase is free from defects in material and workmanship. This warranty does not apply to damage due to heat, physical damage resulting from abuse, neglect, improper repair, improper fit, or alterations of the fixture. This covers the lights and cables only.

For more information, please contact us at cs@moon-sport.com.