

PulmoneticSystems[®]

Innovations For Life



LTV[®] Series Ventilator ***Operator's Manual***

P/N 10664, Rev. T

August 2005

Document Revision History

Document Revision Level	Revision Date
Rev A, ECO 390	January 1999
Rev B, ECO 450	February 1999
Rev C, ECO 478	June 1999
Rev D, ECO 685	October 1999
Rev E, ECO 774	March 2000
Rev F, ECO 868	September 2000
Rev G, ECO 956	December 2000
Rev H, ECO 1127	February 2001
Rev J, ECO 1299	May 2001
Rev K, ECO 1496	October 2001
Rev L, ECO 1722	April 2002
Rev M, ECO 1795	June 2002
Rev N, ECO 1978	August 2002
Rev P, ECO 2610	August 2003
Rev. R, ECO 2723	September 2003
Rev. R01, ECO 2735	December 2003
Rev. S, ECO 2907	April 2004
Rev. T ECO 3412	August 2005

Contact Information

Pulmonetic Systems, Inc.

17400 Medina Rd., Suite 100

Minneapolis, Minnesota 55447-1341

Phone: (763) 398-8300

Customer Care Center: (800) 754-1914

Fax: (763) 398-8400

E-mail: info@pulmonetic.com

Website: <http://www.pulmonetic.com>

LTV® 1000, LTV® 950, LTV® 900, LTV® 800 and LTV® are trademarks belonging to Pulmonetic Systems, Inc.

Copyright © 2005 Pulmonetic Systems, Inc., Minneapolis, Minnesota.

Warranty

Pulmonetic Systems warrants that the LTV[®] Series ventilator is free from defects in material and workmanship for a period of one (1) year from the date of shipment, or 8,800 hours as measured on the usage meter, whichever comes first, with the following limitations:

- 1) Patient circuit components, including hoses, exhalation manifold, and other associated parts are warranted for sixty (60) days from date of shipment.
- 2) The internal battery is warranted for ninety (90) days from date of shipment.

Pulmonetic Systems will, at its option, either repair, replace, or issue credit for products that prove to be defective during the warranty period.

For warranty service or repair, the product must be returned to Pulmonetic Systems or a service facility designated by Pulmonetic Systems, shipping prepaid by the Buyer.

LIMITATION OF WARRANTY

Ordinary maintenance, as specified in the LTV[®] Series ventilator Operator's and Service Manuals, is not covered under the forgoing warranty.

The forgoing warranty does not apply to defects resulting from:

- 1) Improper or inadequate maintenance of the unit;
- 2) Improper use or misuse of the unit;
- 3) Unauthorized modifications or repairs to the unit;
- 4) Use of the unit with unauthorized accessories, e.g. external battery or AC adapter.
- 5) Operation of the unit outside the specified environment.

NO IMPLIED WARRANTIES

This warranty is exclusive. There are no other warranties expressed or implied.

LIMITATION OF LIABILITY

Pulmonetic Systems shall not be liable for loss of profits, loss of use, consequential damages, or any other claim based on breach of warranty. Pulmonetic Systems, Inc.'s liability for damages of any kind shall be limited to the purchase price of the defective unit.

Notices

The LTV[®] Series ventilator complies with limitations as specified in IEC 601-1-2 for Medical Products. It does however, use and radiate radio frequency energy.

The function of this machine may be adversely affected by the operation of other nearby equipment, such as high frequency surgical diathermy equipment, short-wave therapy equipment, defibrillators or MRI equipment.

Federal law restricts this device to sale by or on the order of a physician.



FM 75092
CE 02342

European Regulatory Requirements per 93/42/EEC Medical Device Directives

Pulmonetic Systems, Inc.'s European Representative for vigilance reporting within the European Community is:

MediMark® Europe Sarl.

11, rue Emile Zola. BP 2332

F-38033 Grenoble Cedex 2. France

Tel: +33 (0)4 76 86 43 22

Fax: +33 (0)4 76 17 19 82

E-mail: info@medimark-europe.com

Any product malfunctioning issues that fall under Medical Device Directives Essential Requirements should be directed to MediMark.

Notice To Operators

Unsafe Operation - Operating the LTV[®] Series ventilator without a complete and thorough understanding of its attributes is unsafe and may cause harm to the patient. It is important that this manual be read and understood in its entirety before operating the ventilator.

Warnings and Cautions Section - Read the section on **Warnings** and **Cautions** carefully before operating the LTV[®] Series ventilator.

Use and Maintenance - Any questions regarding installing, operating, or maintaining the LTV[®] Series ventilator, should be directed to a certified Pulmonetic Systems' service technician or Pulmonetic Systems, Inc.

Avis important

Fonctionnement dangereux - L'opération d'un ventilateur de la série LTV[®] sans une excellente compréhension de ses attributs est dangereuse et risque de blesser le patient. Il est très important de lire et de comprendre entièrement ce manuel avant de faire fonctionner le ventilateur.

Section Avertissements et Attention - Lire attentivement la section **Avertissements et Attention** avant de procéder à l'opération des ventilateurs de la série LTV[®].

Utilisation et entretien - En cas de questions concernant l'installation, l'opération ou l'entretien des ventilateurs de la série LTV[®], veuillez vous adresser à un technicien de service certifié de Pulmonetic Systems ou directement à Pulmonetic Systems, Inc.

Contents

Warranty	ii
Notices	iii
Chapter 1 - Introduction	1-1
Operator's Safety Information.....	1-2
Warnings.....	1-3
Cautions.....	1-12
Symbols	1-18
Chapter 2 - Ventilator Overview.....	2-1
Intended Use	2-1
Power/Supplies Required	2-2
Information/Assistance	2-3
Chapter 3 - Breath Types	3-1
Breath Types	3-1
Volume Control Breaths	3-2
Pressure Control Breaths	3-3
Pressure Support Breaths.....	3-5
Spontaneous Breaths.....	3-6
Chapter 4 - Ventilation Modes.....	4-1
Control Mode	4-1
Assist/Control Mode.....	4-1
SIMV Mode	4-2
CPAP Mode	4-3
Apnea Backup	4-4
NPPV	4-5
Volume / Pressure Ventilation	4-6
Bias Flow	4-6
Chapter 5 - Using the Controls and Indicators	5-1
Ventilator Controls	5-1
Setting a Control	5-2
Variable Controls	5-2
Buttons.....	5-3
Set Value Knob.....	5-3
Extended Features	5-3
Mechanical Controls	5-4
Bright, Dim and Blank Control Displays.....	5-5
Flashing Controls.....	5-6
Dashes.....	5-6
Control Limiting.....	5-6
Control Locking.....	5-7

Control Retention	5-7
Chapter 6 - Controls	6-1
Assist/Control / SIMV/CPAP Modes.....	6-1
Breath Rate	6-2
Control Lock	6-3
High Pressure Limit.....	6-4
Inspiratory / Expiratory Hold.....	6-5
Inspiratory Hold.....	6-6
Expiratory Hold	6-8
Inspiratory Time.....	6-10
Low Minute Volume.....	6-11
Low Pressure	6-12
Low Pressure O ₂ Source (LTV® 1000 Only)	6-13
Manual Breath	6-17
O ₂ % (O ₂ Flush) (LTV® 1000 Only)	6-18
On / Standby	6-20
PEEP Valve.....	6-21
Pressure Control (LTV® 1000 & 950 Only).....	6-23
Pressure Support	6-25
Select	6-27
Sensitivity	6-28
Set Value Knob	6-29
Silence / Reset	6-30
Tidal Volume	6-31
Volume / Pressure Mode (LTV® 1000 & 950 Only).....	6-32
Chapter 7 - Displays and Indicators	7-1
Airway Pressure	7-1
Display Window.....	7-1
Indicators.....	7-1
Battery Level	7-2
Charge Status	7-4
External Power	7-5
NPPV.....	7-6
Patient Effort.....	7-6
Vent Inop.....	7-6
Chapter 8 - Monitored Data	8-1
Automatic or Manual Data Display Scrolling.....	8-2
PIP xxx cmH ₂ O	8-3
MAP xx cmH ₂ O.....	8-3
PEEP xx cmH ₂ O	8-3
f xxx bpm	8-3
Vte xxx ml.....	8-4

VE xx.x L.....	8-4
I:E xx:xx	8-4
I:Ecalc xx:xx	8-4
Vcalc xxx Lpm.....	8-4
Chapter 9 - Ventilator Alarms.....	9-1
APNEA, APNEA xx bpm.....	9-2
BAT EMPTY	9-3
BAT LOW.....	9-5
DEFAULTS.....	9-7
DEFAULTS SET	9-9
DISC/SENSE	9-10
HIGH f.....	9-11
HIGH O ₂ PRES (LTV® 1000 Only).....	9-12
HIGH PEEP	9-13
High PRES.....	9-14
HW FAULT	9-16
INOP	9-17
LOW MIN VOL.....	9-18
LOW O ₂ PRES (LTV® 1000 Only).....	9-19
LOW PRES.....	9-20
NO CAL DATA, NO CAL Monitor Display	9-21
POWER LOST.....	9-22
POWER LOW	9-23
REMOVE PTNT.....	9-24
RESET	9-25
XDCR FAULT	9-26
Alarm Status Messages.....	9-27
f PEEP OFF.....	9-27
HI PEEP OFF	9-27
HIGH f OFF	9-28
LMV LPPS OFF.....	9-28
LMV OFF.....	9-28
LOCKED.....	9-29
LPPS OFF	9-29
WARMUP xx	9-30
Chapter 10 - Extended Features	10-1
Navigating the Extended Features Menus	10-2
Alarm Operations.....	10-3

Alarm Volume	10-3
Apnea Interval.....	10-4
High Pressure Alarm Delay	10-4
Low Peak Pressure Alarm	10-4
High f.....	10-5
High PEEP	10-5
Patient Assist	10-6
Exit	10-6
Vent Operations	10-7
Variable Rise Time.....	10-8
Variable Flow Termination	10-9
Variable Time Termination.....	10-10
Pressure Control Flow Termination	10-11
Leak Compensation	10-12
NPPV Mode	10-13
O2 Flush (LTV® 1000 Only)	10-14
Control Unlock	10-15
Language Selection	10-15
Software Version.....	10-16
Usage Meter	10-16
Communications Setting.....	10-16
Set Date	10-17
Set Time.....	10-18
Date Format	10-18
PIP LED	10-19
Model Number / Serial Number	10-19
Valve Home Position	10-20
Set Defaults	10-20
O2 Cylinder Duration (LTV® 1000 Only)	10-21
Exit	10-22
Transducer Autozero.....	10-23
Airway Pressure Transducer Autozero.....	10-23
Bi-directional Flow Transducer Differential Autozero	10-24
Exhalation Flow Transducer Differential Autozero - Narrow	10-25
Exhalation Flow Transducer Differential Autozero - Wide.....	10-26
Real Time Transducers.....	10-27
 Chapter 11 - Ventilator Checkout Tests.....	 11-1
Alarm Test.....	11-3
Display Test.....	11-4
Control Test.....	11-6
Leak Test.....	11-8
Vent Inop Alarm Test	11-10
Exit	11-12

Chapter 12 - Operating Procedure	12-1
To Turn the Ventilator On	12-1
Before Connecting the Ventilator to a Patient	12-2
Procedure for Control Mode Set Up	12-4
Procedure for Assist / Control Mode Set Up.....	12-5
Procedure for SIMV Mode Set Up	12-6
Procedure for CPAP Mode Set Up	12-7
Procedure for NPPV Mode Set Up	12-7
Procedure for NPPV Mode Set Up	12-8
To Turn the Ventilator Off	12-9
LTV® Ventilator Settings Checklist.....	12-10
 Chapter 13 - Cleaning, Disinfecting and Sterilizing	 13-1
Cleaning the Ventilator	13-1
Cleaning or replacing the Fan Filter	13-2
Cleaning or replacing the Inlet Filter.....	13-3
Cleaning or Replacing the O2 Inlet Filter.....	13-4
Cleaning the Exhalation Valve and Reusable Patient Circuit.....	13-6
 Chapter 14 - Power and Battery Operation.....	 14-1
Using the AC Adapter	14-2
Using an External Battery	14-3
Using the Automobile Cigarette Lighter Adapter	14-6
Replacing the Automobile Adapter Fuse.....	14-10
The Universal Power Supply (UPS)	14-10
The Transport Battery System (TBS)	14-10
Caring for the Internal Battery	14-11
Battery Disposal	14-11
 Chapter 15 - Troubleshooting.....	 15-1
Displays and Buttons	15-2
Ventilator Performance	15-5
Power and Battery Operation	15-14
Alarms.....	15-16
Checkout Test Failures.....	15-21
Test Lung Operations	15-23
 Appendix A - Ventilator Specifications	 A-1
 Appendix B - Set Up / Maintenance.....	 B-1
Recommended Maintenance Schedule.....	B-1
Service Assistance	B-2
 Appendix C - Installation and Checkout	 C-1
Installation and Setup	C-1

Unpacking the Ventilator – Instructions	C-1
Protective Boots	C-2
Protective Boot Removal	C-3
Protective Boot Installation	C-6
Patient Breathing Circuit – Connection Instructions	C-9
Patient Breathing Circuit – Connection Instructions	C-10
Oxygen Lines – Connection Instructions	C-12
Patient Assist Call System – Connection Instructions	C-14
Communications Port	C-15
LTM™ Graphics Monitor	C-15
Using the Remote Alarm Cable	C-16
Checking the Ventilator for Proper Operation	C-18
Ventilator Proper Operation Worksheet	C-20
Appendix D - Principles of Operation	D-1
Overview	D-1
Appendix E - Event Trace	E-1
Event Codes	E-3
Event Codes by Code #	E-3
Event Codes by Event Name	E-6
Appendix F - Glossary	F-1
Appendix G - Index	G-1

Chapter 1 - INTRODUCTION

This Operator's Manual contains detailed information and instructions which when adhered to, ensure the safe and effective set up, use and simple maintenance of the LTV® 1000, 950, and 900 Ventilators.

It is designed for use by Respiratory Therapists or other qualified and trained personnel under the direction of a physician and in accordance with applicable state laws and regulations. It contains the following:

- Ventilator Overview
- Installation and Checkout
- Using the Controls and Indicators
- Monitored Data
- Ventilator Alarms
- Extended Features
- Ventilator Checkout tests
- Operating Procedure
- Troubleshooting
- Cleaning, Disinfecting and Sterilizing
- Set Up / Maintenance
- Power and Battery Operation

Service tests, calibration, and major maintenance operations are described in the LTV® Series ventilator Service Manual (P/N 10665).

Operator's Safety Information

All Operators are to read and understand the following information about **Warning**, **Caution** and **Note** statements before operating the LTV[®] Series ventilator.

WARNING

“**WARNING**” statements alert the reader to potentially hazardous situations which, if not avoided, could result in death or serious injury.

AVERTISSEMENT

Les énoncés « **AVERTISSEMENT** » informent le lecteur de situations dangereuses qui, si elles ne sont pas évitées, peuvent entraîner la mort ou des blessures graves.

CAUTION

“**CAUTION**” statements alert the reader to potentially hazardous situations which, if not avoided, could result in equipment damage.

ATTENTION

Les énoncés « **ATTENTION** » informent le lecteur de situations dangereuses qui, si elles ne sont pas évitées, peuvent causer des dommages à l'équipement.

NOTE

“**NOTE**” statements contain additional information to assist in the proper operation of the LTV[®] Series ventilator.

REMARQUE

Les énoncés « **REMARQUE** » contiennent des informations supplémentaires pour aider à l'opération adéquate des ventilateurs de la série LTV[®].

WARNING

Untrained Personnel – Only properly trained personnel should operate the ventilator. The LTV® Series ventilator is a restricted medical device designed for use by Respiratory Therapists or other properly trained and qualified personnel under the direction of a physician and in accordance with applicable state laws and regulations.

Leak Testing the Patient Breathing Circuit – The patient circuit must be leak tested in the **VENT CHECK** mode before connection to the patient. In addition, the Ventilator Checkout mode should be used to check for correct operation of the ventilator alarm, displays and controls. Harm to the patient or ineffective ventilation may result from failure to leak test the patient breathing circuit before connection to a patient. When using a heated humidifier, include it in the circuit when performing leak testing.

Adjustable and Critical Alarms – For safety purposes, all adjustable alarms and all critical alarms must be checked to insure proper operation.

Alarms Function Verification - All alarms must be verified as functioning properly on a daily basis. If any alarm malfunctions, immediately contact a certified Pulmonetic Systems' service technician or Pulmonetic Systems, Inc.

Patient Monitoring - Patients who are dependent on a ventilator should be constantly monitored by qualified personnel. Such personnel should be prepared to address equipment malfunctions and circumstances where equipment becomes inoperative. An alternative method of ventilation should be available for all patients dependent on the ventilator, and qualified personnel should be fully familiar with emergency ventilation procedures.

Alternative Ventilation - It is recommended that an alternative means of ventilating the patient be available at all times and that all ventilator operators be fully familiar with emergency ventilation procedures.

Fire or Explosion - Operation of the LTV® Series ventilator in the presence of flammable gases could cause a fire or explosion. Under no circumstances is the ventilator to be operated when explosive gases are present. The presence of nitrous oxide or flammable anesthetics presents a danger to the patient and operator.

Patient Breathing Circuit Disconnection - Inadvertent disconnection of the patient from the patient breathing circuit can be dangerous.

Critical Alarms - Failure to set the critical alarms such as the Low Minute Volume alarm and the Low Pressure alarm may cause non-detection (no alarm) for a disconnection of the lower sense line or the exhalation valve drive line.

Exhalation Valve Diaphragm – Patient ventilation may be ineffective or dangerous if the exhalation valve diaphragm is damaged or worn out. The exhalation valve diaphragm must be inspected on a daily basis and replaced whenever necessary.

Sustained HIGH PRES Alarm - During a sustained High Pressure alarm condition (**HIGH PRES**), the ventilator's turbine is stopped and gas is not delivered to the patient. Disconnect the patient from the ventilator and ventilate the patient using an alternative method. See *Chapter 15 - Troubleshooting, Alarms* for additional information concerning the **HIGH PRES** alarm.

WARNING

BAT EMPTY Alarm - A BAT EMPTY alarm indicates the internal battery is almost depleted. Connect the ventilator to an external power source immediately.

Battery run time - When the battery reaches the BAT LOW level, the ventilator will only run for approximately 10 minutes before generating a battery empty alarm (BAT EMPTY). The approximate time shown is based on tests using the nominal settings, a new battery and a full 8 hour charge cycle as specified in Appendix A - Ventilator Specifications. Actual run time may be more or less depending on ventilator settings, patient demand, and battery age or condition. It is highly recommended that an alternate power source is connected PRIOR to the ventilator reaching the BAT EMPTY alarm condition to ensure continuous, uninterrupted patient ventilation

INOP Alarm - If an INOP alarm occurs during operation, ventilate the patient using an alternative method, disconnect the ventilator, and immediately contact a certified Pulmonetic Systems' service technician or Pulmonetic Systems, Inc.

NO CAL Condition - Operation of the LTV® Series ventilator under a NO CAL condition may result in inaccurate pressure and volume measurements. Should this condition occur, disconnect the patient from the ventilator, provide an alternative method of ventilation and immediately contact a certified Pulmonetic Systems' service technician or Pulmonetic Systems, Inc.

XDCR FAULT Alarm - Continued operation of the LTV® Series ventilator with an activated XDCR FAULT alarm may result in inaccurate flow and volume measurements. Should this condition occur, disconnect the patient from the ventilator, provide an alternative method of ventilation and immediately contact a certified Pulmonetic Systems' service technician or Pulmonetic Systems, Inc.

Personal Injury and Electric Shock - Operation of the LTV® Series ventilator if any of its panels have been removed may result in electrical shock to the patient or operator. All servicing must be performed by a certified Pulmonetic Systems' service technician.

NPPV Mode – NPPV1 is not a life support mode and is not suitable for patients that require life support ventilation. NPPV Mode should only be used for supplemental ventilation of non-life support patients.

NPPV Mode - When operating in NPPV1 mode, many of the standard alarms are disabled. This may result in reduced ventilation accuracy should a problem occur. Carefully read Chapter 4 - Ventilation Modes,

NPPV, before selecting this mode of operation.

Accuracy of PEEP setting - Variations in the patient's breathing pattern and/or leaks in the patient circuit (including leaks around the tracheostomy tube cuff) can affect PEEP. PSI recommends that the clinician set the PEEP to the prescribed level on a test lung while observing the PEEP value in the LTV display window. The clinician should also periodically monitor the PEEP value in the LTV display window. Using an inaccurate PEEP setting due to a patient leak can result in less than prescribed PEEP or undesirable increases in patient circuit pressure when the patient circuit leak changes.

Audible Alarms - Failure to immediately identify and correct audible alarm situations may result in serious patient injury.

¹ NPPV, Non-Invasive Positive Pressure Ventilation

WARNING

Equipment Malfunction or Failure - The LTV® Series ventilator has alarms to notify operators of certain conditions and to cease operating upon detecting possible danger. In the event of equipment failure, all ventilator operators should have an alternative method of ventilation available and be fully familiar with emergency ventilation procedures.

Improperly Functioning Ventilator - Operation of a ventilator that does not appear to be working properly may be hazardous. If the ventilator is damaged, fails Ventilator Checkout tests or malfunctions in any way, discontinue its use and immediately contact a certified Pulmonetic Systems' service technician or Pulmonetic Systems, Inc.

Ventilator Checkout Tests – Be aware that gas is not delivered to the patient during these tests. Disconnect the patient from the ventilator and ventilate the patient using an alternative method before running the Ventilator Checkout tests.

Ventilator Checkout and Maintenance Modes - The LTV® Series ventilator does not deliver gas during the Ventilator Checkout mode (VENT CHECK) or Ventilator Maintenance mode (VENT MTNCE) and should not be used to ventilate a patient during these tests.

Inspired Oxygen (FIO₂) Concentration – If the patient has a variable respiratory rate, his/her minute ventilation will fluctuate. If exact concentrations of inspired oxygen (FIO₂) are required to be delivered to the patient, it is recommended that an accurate oxygen analyzer with alarms be used.

O₂ Cylinder Duration Information - The accuracy of the displayed useable amount of oxygen remaining in an external O₂ cylinder (O₂ DUR hh:mm) is dependant on the precision of the pressure gauge used on the O₂ cylinder and the accuracy of the information provided by the operator in the O₂ CYL DUR menu settings. The calculated/displayed useable amount of oxygen information is to be used for reference purposes only.

Ventilation Variables and O₂ Consumption - Variations in the patient's minute ventilation, I:E ratio and/or ventilator setting changes or equipment status (i.e. circuit leaks) affect the consumption rate of oxygen. When warranted by a patients condition, it is recommended that a back-up cylinder or alternative source of oxygen be available at all times.

Before Using Automobile Cigarette Lighter or Power Outlets - Before using Automobile Cigarette Lighter or Power Outlets as a power source for the LTV® ventilator, assure that the ventilator's internal battery is in good condition and fully charged. Poor cigarette lighter or power outlet connections, electrical system defects (battery, charging system, etc.), or use of vehicle accessories (air conditioner, high current lights, high power audio equipment, etc.) could result in less than the required voltage being delivered to the ventilator, generate a Power Lost alarm and switch the ventilator's power source to the internal battery.

Unauthorized Parts or Accessories – Serious harm to the patient may result from the use of unauthorized parts or accessories. Only items expressly approved by Pulmonetic Systems may be used in conjunction with the LTV® Series ventilators.

Unapproved Adapters – Only Pulmonetic Systems Accessories should be used to connect the ventilator to Patient Assist Call Systems. These accessories incorporate safety features to reduce the risk of shock. Do not attempt to modify these accessories in any way.

Patient Assist Call Connector – Do not apply more than 25V rms or 32VDC to the Patient Assist Call connector.

WARNING

Ventilator Service and Repair - All servicing or repair of the LTV® Series ventilator must be performed only by a service technician certified by Pulmonetic Systems

Disabled Oxygen Inlet Pressure Alarms - When the oxygen blending option is not installed, the Oxygen Inlet Pressure Alarms are disabled.

Patient Circuits – Pulmonetic Systems Patient Circuits, Exhalation Valve Assemblies and Water Traps are shipped clean, not sterile.

Ultra Violet Light Sensitivity – The material used in the tubing of the “Re-usable” Patient Circuits is not UV stable. Avoid exposure of the tubing to UV light.

PEEP Valve Rotation – Attempting to adjust the PEEP valve counterclockwise past zero (0) may damage the PEEP valve assembly or cause circuit leaks. Accessories

Mounting Screws - Refer to the information contained in Pulmonetic Systems Replacement Screws Kit, P/N 11149, to determine the appropriate accessories mounting screws or accessories replacement screws location, type and length to use when removing or exchanging external accessories on an LTV® Series ventilator.

Mounting Screw Use – Internal damage to the ventilator may result if the wrong length mounting screws are used when installing or removing external accessories.

Specific Boot Replacement Screw Location - One leg of the upper protective boot has an additional screw hole (furthest from the end of the leg); On earlier version ventilators (screw was located in the upper hole in the leg of the boot) the use of a 3/16” mounting screw is required. On current version ventilators (screw was located in the lower hole in the leg of the boot) the use of a 1/4” mounting screw is required.

Specific Boot Installation Screw Location - One leg of the upper protective boot has an additional screw hole (furthest from the end of the leg); On earlier version ventilators, the screw hole will align with the upper hole in the boot and requires the use of the 1/4” mounting screw. On current version ventilators, the screw hole will align with the lower hole in the boot and requires the use of the 3/8” mounting screw.

Patient Circuit Accessories - The use of accessories such as Speaking Valves, Heat-Moisture Exchangers and Filters create additional patient circuit resistance and in the event of a disconnection, may impede the generation of a Low Pressure Alarm. Ensure that the Low Pressure Alarm settings accommodate these types of accessories when used in combination with patient circuits.

Low Minute Volume Control Settings - The Low Minute Volume control should be set to its highest clinically appropriate value. If there is a clinical need to set the Low Minute Volume alarm to lower values or off (“- -”), perform a clinical assessment to determine if an alternative monitor (i.e. a Pulse Oxymeter with an audible alarm, or a Cardio Respiratory Monitor) should be used.



AVERTISSEMENT

Personnel non qualifié - Seul le personnel qualifié doit opérer le ventilateur. Le ventilateur de la série LTV[®] est un dispositif médical restreint conçu pour être utilisé par les inhalothérapeutes ou autres personnes qualifiées, et par le personnel qualifié sous la supervision d'un médecin et en conformité avec les lois et règlements applicables.

Contrôle de l'étanchéité du circuit respiratoire du patient – L'étanchéité du circuit respiratoire du patient (vérification de ventilation) doit être vérifiée en mode **VENT CHECK** avant le raccordement au patient. En outre, on doit utiliser le mode Ventilator Checkout (vérification du ventilateur) afin de s'assurer du fonctionnement adéquat de l'alarme, des affichages et des commandes du ventilateur. Le défaut de vérifier l'étanchéité du circuit respiratoire du patient avant le raccordement à un patient peut être nocif pour le patient ou provoquer une ventilation inefficace. Lorsqu'un humidificateur chauffant est employé, il convient de l'inclure dans le circuit en procédant à la vérification de l'étanchéité.

Alarmes ajustables et critiques - Afin d'assurer l'opération sécuritaire des ventilateurs de la série LTV[®], toutes les alarmes ajustables doivent être réglées avant l'opération. De plus, toutes les alarmes critiques (par exemple, alarme de basse pression), doivent être inspectées avant de laisser le patient seul.

Vérification du fonctionnement des alarmes - Toutes les alarmes sonores et visuelles doivent être vérifiées quotidiennement. Si une des alarmes fonctionne de façon inadéquate, contactez votre technicien de service certifié de Pulmonetic Systems ou Pulmonetic Systems Inc.

Surveillance du patient – Un personnel qualifié doit constamment surveiller les patients qui sont reliés à un ventilateur. Le personnel doit être en mesure de s'occuper des déficiences de fonctionnement de l'équipement ainsi que des circonstances où ce dernier devient inopérant. Une forme de ventilation alternative doit être disponible à tous les patients reliés au ventilateur et le personnel qualifié devrait être pleinement familier avec les procédures de ventilation d'urgence.

Ventilation alternative - Il est recommandé qu'un moyen alternatif de ventilation soit disponible en tout temps, et que tous les opérateurs de ventilateur soient pleinement familiers avec les procédures de ventilation d'urgence.

Feu ou explosion - L'opération des ventilateurs de la série LTV[®] en présence de gaz inflammables peut causer un feu ou une explosion. Le ventilateur ne doit être opéré sous aucune circonstance en présence de gaz. La présence d'oxyde nitreux ou d'anesthésiques inflammables représente un danger pour le patient et l'opérateur.

Débranchement du circuit respiratoire du patient - Le débranchement accidentel du circuit respiratoire du patient peut s'avérer dangereux.

Alarmes critiques – Le défaut de définir les alarmes critiques telles que l'alarme basse ventilation-minute et l'alarme basse pression peut causer une non-détection (absence d'alarme) pour un débranchement du tube de détection inférieur ou du tube d'entraînement de la soupape d'expiration.

Diaphragme de la soupape d'expiration - Une ventilation inefficace ou dangereuse pour le patient peut résulter si le diaphragme de la soupape est endommagé ou usé. Le diaphragme de la soupape d'expiration doit être vérifié quotidiennement, et remplacé au besoin.

Alarme ALARME P_{MAX} continue — Dans des conditions d'alarme de haute pression prolongées (**ALARME P_{MAX}**), la turbine du ventilateur s'arrête et le gaz n'est plus transmis au patient. Débranchez le patient du ventilateur et utilisez une autre méthode de ventilation. Pour plus de détails sur l'état **ALARME P_{MAX}**, reportez-vous au *chapitre 15, Troubleshooting, Alarms*.



AVERTISSEMENT

Durée d'utilisation de la batterie – Lorsque la batterie atteint le niveau BAT INT BASS, le ventilateur fonctionne pendant environ 10 minutes avant d'émettre une alarme de batterie faible (BAT INT VIDE). Cette durée approximative est basée sur des tests avec des paramètres nominaux, une nouvelle batterie et un cycle de chargement complet de 8 heures, tel que spécifié dans *l'Annexe A – Spécifications du ventilateur*. La durée d'utilisation réelle pourrait être supérieure ou inférieure, selon les paramètres du ventilateur, la demande du patient et l'âge ou l'état de la batterie. Il est fortement recommandé qu'une source d'alimentation alternative soit connectée AVANT que le ventilateur n'atteigne l'état d'alarme BAT INT VIDE afin d'assurer une ventilation continue et ininterrompue au patient.

Alarme BAT EMPTY - Une alarme BAT EMPTY indique que la pile interne est pratiquement à plat. Branchez immédiatement le ventilateur à une source d'alimentation externe.

Alarme INOP - Si une alarme INOP survient au cours de l'opération, ventilez le patient à l'aide de la méthode alternative, retirez immédiatement le ventilateur du service, et contactez immédiatement votre technicien de service certifié de Pulmonetic Systems ou Pulmonetic Systems Inc.

Condition NO CAL - L'opération continue du ventilateur de la série LTV® sous condition NO CAL peut résulter en mesures de pression et de volume erronées. Si cette condition se présente, le ventilateur doit être retiré du service, et vous devez immédiatement contacter votre technicien de service certifié de Pulmonetic Systems ou Pulmonetic Systems Inc.

Alarme XDCR FAULT - L'opération continue du ventilateur de la série LTV® avec une alarme XDCR FAULT activée peut résulter en mesures de débit et de volume erronées. Si cette condition se présente, le ventilateur doit être retiré du service, et vous devez immédiatement contacter votre technicien de service certifié de Pulmonetic Systems ou Pulmonetic Systems Inc.

Blessures personnelles et chocs électriques - L'opération d'un ventilateur de la série LTV® alors que ses panneaux sont enlevés, peut causer un choc électrique au patient ou à l'opérateur. Tout entretien doit être effectué par un technicien de service certifié de Pulmonetic Systems.

Mode NPPV – Le mode NPPV n'est pas un mode de maintien des fonctions vitales continu et il n'est pas approprié pour les patients qui ont besoin d'une ventilation continue pour le maintien des fonctions vitales. Le mode NPPV ne doit être utilisé que comme ventilation supplémentaire pour les patients qui ne nécessitent pas de maintien des fonctions vitales.

Mode NPPV – Lorsque l'appareil fonctionne en mode NPPV, bon nombre des alarmes standards sont désactivées. Par conséquent, si un problème survient, la précision de la ventilation pourrait diminuer. Assurez-vous de lire attentivement le chapitre 4 – Types de respiration et modes de ventilation, mode NPPV avant de choisir ce mode de fonctionnement.

Exactitude du paramètre PEP – Les écarts dans le mode de respiration du patient et/ou les fuites du circuit du patient (y compris les fuites autour du ballonnet pour canule de trachéostomie) peuvent affecter le PEP. Des études et investigations préliminaires recommandent que le clinicien définisse le PEP au niveau prescrit sur un poumon d'essai tout en observant la valeur PEP de l'écran graphique LTV. Le clinicien doit par ailleurs surveiller de façon périodique la valeur PEP de l'écran graphique LTV. L'utilisation d'un paramètre PEP inapproprié en raison d'une fuite de patient peut potentiellement résulter en un paramètre inférieur au paramètre PEP prescrit ou en une augmentation indésirable de la pression du circuit du patient lorsque la fuite du circuit du patient change.

Alarmes sonores - L'échec à identifier et à corriger dans l'immédiat les situations d'alarmes sonores peut causer des blessures au patient.

AVERTISSEMENT

Mauvais fonctionnement ou panne de l'équipement - Des dispositifs électromécaniques peuvent mal fonctionner ou subir une panne. Le ventilateur de la série LTV® a été conçu avec des alarmes, pour détecter et aviser les opérateurs de certaines conditions, et pour cesser d'opérer en cas de conditions d'opération dangereuses. En cas de panne de l'équipement, tous les opérateurs du ventilateur devraient avoir une forme de ventilation alternative à leur disponibilité, et être pleinement familiers avec les procédures de ventilation d'urgence.

Ventilateurs fonctionnant de façon inadéquate - L'opération d'un ventilateur dont le fonctionnement semble inadéquat peut représenter un danger. Si le ventilateur est endommagé, s'il échoue les tests de vérification du ventilateur ou s'il fonctionne de façon inadéquate, suspendez l'utilisation de ce ventilateur et contactez immédiatement votre technicien de service certifié de Pulmonetic Systems Inc.

Tests de vérification du ventilateur – Noter que le gaz n'est pas transmis au patient au cours de ces tests. Débrancher le patient du ventilateur et ventiler le patient à l'aide d'une forme de ventilation alternative avant de procéder aux tests de vérification du ventilateur.

Modes Vérification et Entretien du ventilateur - Le ventilateur de la série LTV® ne transmet pas le mélange de gaz en mode Vérification du ventilateur (VENT CHECK) ou en mode Entretien du ventilateur (VENT MTNCE), il ne devrait donc pas être utilisé pour ventiler un patient durant l'exécution de ces tests.

Concentration d'oxygène inspiré (FIO₂) – Si la fréquence respiratoire du patient est variable, sa ventilation-minute va fluctuer. Lorsqu'une concentration exacte d'oxygène inspiré (FIO₂) est nécessaire pour une transmission au patient, il est recommandé d'utiliser un analyseur de niveau d'oxygène² précis, comportant des alarmes.

Informations sur la durée d'utilisation restante de la bouteille d'oxygène - La précision de l'affichage de la quantité d'oxygène utilisable restante dans une bouteille d'oxygène externe (O₂ DUR hh:mm) dépend de la précision de la jauge de pression utilisée sur la bouteille et de l'exactitude des informations fournies par l'opérateur dans les paramètres du menu DUREE CYL O₂. Les informations calculées et affichées sur la quantité d'oxygène utilisable ne doivent être utilisées qu'à titre indicatif.

Variables de ventilation et consommation d'oxygène — Les variations dans la ventilation par minute du patient et dans le rapport inspiration/expiration, la modification des paramètres ou l'état du matériel (fuite dans le circuit, par exemple) modifient le taux de consommation de l'oxygène. Lorsque la situation du patient le permet, il est recommandé qu'une bouteille d'oxygène de secours ou toute autre source alternative d'oxygène soit disponible en permanence.

Avant toute utilisation d'une prise d'allume-cigare ou d'une prise de courant — Avant d'utiliser un allume-cigare ou une prise de courant comme source d'alimentation du ventilateur LTV®, vérifiez que la batterie interne du ventilateur est en bon état et entièrement chargée. L'utilisation d'un allume-cigare ou d'une prise de courant fournissant un branchement de qualité médiocre, des défauts du circuit électrique (batterie, système de charge, etc.), ou l'utilisation d'accessoires d'automobile (climatisation, phares, chaîne stéréo et haut-parleurs à forte consommation, etc.) peuvent affecter le voltage délivré au ventilateur et provoquer une sous-alimentation de celui-ci. Dans cette situation, le ventilateur déclenche une alarme PAS ALIM SEC et utilise la batterie interne du ventilateur comme source d'alimentation.

Pièces, accessoires et options non autorisées - Des dommages à l'équipement ou des blessures au patient peuvent survenir suite à l'utilisation de pièces, accessoires et options non autorisées. Seuls les éléments expressément approuvés par Pulmonetic Systems doivent être utilisés en conjonction avec les ventilateurs de la série LTV®.



AVERTISSEMENT

Accessoires non approuvés – L'utilisation d'accessoires qui ne sont pas expressément approuvés par Pulmonetic Systems pourrait entraîner des conditions dangereuses. Seuls les accessoires de Pulmonetic Systems devraient être utilisés pour brancher les ventilateurs aux systèmes d'aide aux patients. Ces accessoires comportent des caractéristiques de sécurité pour réduire les risques de choc. N'essayez pas de modifier ces accessoires d'aucune façon.

Connecteur d'appel d'aide aux patients – Ne mettez pas plus de 25 V efficace ou 32 V c.c. au connecteur d'appel d'aide aux patients.

Entretien et réparation du ventilateur - Tout entretien ou réparation du ventilateur de la série LTV® ne doit être effectué que par un technicien de service certifié de Pulmonetic Systems.

Alarmes de pression d'entrée de l'oxygène désactivées - Lorsque l'option de mélange d'oxygène n'est pas activée, les alarmes de pression d'entrée de l'oxygène sont désactivées.

Circuits du patient – Les circuits du patient du Pulmonetic Systems, les valves expiratoires et les collecteurs d'eau sont expédiés propres, mais pas stériles.

Sensibilité à la lumière ultraviolette – Les matériaux utilisés pour la tubulure des circuits du patient ne sont pas stables sous rayons UV. Éviter d'exposer la tubulure à la lumière UV.

Rotation de la valve de pression expiratoire positive – Si vous essayez d'ajuster la valve de pression expiratoire positive en sens inverse des aiguilles d'une montre passé zéro (0), vous pourriez endommager la valve de pression expiratoire positive ou causer une fuite dans le circuit.

Vis de montage des accessoires – Voir les renseignements fournis dans la trousse de vis de remplacement de Pulmonetic Systems, numéro de pièce 11149, pour déterminer l'emplacement, le type et la longueur des vis de montage d'accessoires ou des vis de remplacement pour accessoires à utiliser lors de la dépose ou de l'échange d'accessoires externes sur un ventilateur de la série LTV®.

Utilisation des vis de montage – Vous pourriez causer des dommages internes au ventilateur si des vis de montage de mauvaise longueur sont utilisées lors de l'installation ou de la dépose des accessoires externes.

Emplacement des vis de remplacement d'un gaine spécifique – Une patte de la gaine protectrice supérieure possède un trou de vis supplémentaire (le plus éloigné de l'extrémité de la patte);

- Sur les anciennes versions des ventilateurs (la vis se trouvait dans le trou supérieur de la patte de la gaine), vous devez utiliser une vis de montage de 3/16".
- Sur la version actuelle des ventilateurs (la vis se trouve dans le trou inférieur de la patte de la gaine), vous devez utiliser une vis de montage de 1/4".

Emplacement des vis d'installation d'un gaine spécifique – Une patte de la gaine protectrice supérieure possède un trou de vis supplémentaire (le plus éloigné de l'extrémité de la patte);

- Sur les anciennes versions des ventilateurs, le trou de la vis s'alignera au trou supérieur de la gaine et vous devez utiliser une vis de montage de 1/4".
- Sur la version actuelle des ventilateurs, le trou de la vis s'alignera au trou inférieur de la gaine et vous devez utiliser une vis de montage de 3/8".



AVERTISSEMENT

Accessoires du circuit du patient - L'utilisation d'accessoires tels que les membranes vocales, les échangeurs thermohydriques et les filtres, produit une résistance additionnelle dans le circuit de patient et en cas de débranchement, elle risque d'empêcher la génération de l'alarme de basse pression. S'assurer que les paramètres de l'alarme de basse pression s'adaptent à ces types d'accessoires lorsqu'ils sont utilisés avec les circuits du patient.

Réglages du contrôle de volume bas par minute - Le contrôle du volume bas par minute doit être ajusté à la plus haute valeur clinique appropriée. Si l'alarme de volume bas par minute doit être ajustée à des valeurs inférieures ou mise à l'arrêt (" - - ") pour satisfaire aux besoins cliniques, effectuer une évaluation clinique afin de déterminer si l'utilisation d'un autre moniteur (c.-à-d., sphygmo-oxymètre muni d'une alarme sonore ou un moniteur cardio-respiratoire) s'avère pertinente.

Cautions

CAUTION

Ventilator Sterilization – To avoid irreparable damage to the LTV® Series ventilator, do not attempt to sterilize it.

Cleaning Agents – To avoid damaging the ventilator's plastic components and front panel, do not use cleaning agents containing ammonium chloride, other chloride compounds, more than 2% glutaraldehyde, phenols, or abrasive cleaners.

Ventilator Immersion - Do not immerse the ventilator in liquids.

Reusable Patient Circuit Components - To avoid degradation of the reusable patient circuit components, do not exceed the following constraints:

- 50 cleaning cycles or 1 year (whichever comes first)

Steam Autoclave:

- Pressure: 20 PSIG
- Temperature: 275°F (135°C)
- Time: 6 minutes

Liquid Sterilizing Agent:

- The use of liquid agents containing more than 2% glutaraldehyde.

Pasteurization:

- A 30-minute warm water detergent and a 30-minute 165°F (74°C) hot water cycle.
- Drying in a sterile drier for more than 1 hour or 140°F (59°C).

Gas (ETO):

- Temperature: 131°F (55°C)

Differential Pressure Ports - A low pressure air nozzle with flow less than 10 liters per minute should be used for cleaning the differential pressure ports.

Exhalation Valve Cleaning - Do not pour or spray liquid cleaners into the exhalation valve.

Patient Wye Installation – After cleaning, install the patient wye in the patient circuit so the proximal sense lines are oriented up while operating.

Care of the Exhalation Valve - The exhalation valve is a delicate assembly and may be damaged if;

- Care is not exercised when handling or cleaning it.
- Cleaning instruments or foreign bodies are inserted into it.
- High-pressure gas nozzles are used to dry it.

Front Panel Cleaning – Do not pour or spray liquid cleaners onto the front panel.

Care of Bacterial Filters – If bacterial filters are used in conjunction with the LTV® Series ventilator, comply with all procedures as specified by the filter manufacturer.

Wet or Damp Filters - Do not install a wet or damp filter into the LTV® Series ventilators. This could damage the ventilator.

CAUTION

Oxygen Supply Contamination - The accuracy of the oxygen delivery capabilities of LTV® ventilators can be compromised by foreign debris contamination in the oxygen supply system. To reduce the risk of airborne contaminants entering the ventilator, ensure that any oxygen supply connected to the ventilator is clean, properly filtered² and that the ventilator's O2 Inlet Port Cap is securely installed on the O2 Inlet Port whenever the ventilator is not connected to an external oxygen supply.

Proximal Sense Lines - Do not remove the proximal sense lines from the patient wye.

Automobile Cigarette Lighter and Power Outlets – Automobile cigarette lighter and power outlets are normally wired for a positive center contact and ground sleeve contact. Connecting the ventilator to an improperly wired outlet will cause the adapter fuse to blow and may damage the adapter or the ventilator.

Automobile Cigarette Lighter Outlet Power Rating - Running a ventilator from an improperly rated automobile cigarette lighter outlet (less than 20 amperes) may cause a fuse in the automobile to blow, causing the ventilator and possibly other accessories in the automobile to stop operating.

Automobile Cigarette Lighter Adapter - Do not operate the ventilator from the Automobile Cigarette Lighter Adapter while starting the vehicle or when jump starting the automobile battery. Doing so may cause damage to the ventilator.

Automobile Cigarette Lighter Adapter Tip - Use care when disconnecting the Automobile Cigarette Lighter Adapter after use, its tip may be hot.

Automobile Cigarette Lighter Outlet – Depending on the condition of the automobile battery, whether the automobile is turned off, being started or running, automobile cigarette lighter outlets can provide varying levels of voltage (in some, the outlet only operates when the vehicle is running). Verify which power source the ventilator is using by checking the **EXTERNAL POWER** LED on the ventilator.

Remote Alarm - Always verify that the remote alarm properly reports the LTV® Series ventilator alarms before use.

Remote Alarm - Always follow the remote alarm manufacturer's usage and maintenance requirements to guarantee proper function of the device.

External Battery Pack - The External Battery Pack should only be connected to the LTV® Series ventilator using the Pulmonetic Systems External Battery Cable (PN 10802). This cable is pre-wired and properly terminated to ensure safe connection of the External Battery Pack to the ventilator.

Electrical Grounding – In the event of a loss of electrical protective ground, touching the ventilator could result in electrical shock. To ensure grounding and avoid this danger, use only the unmodified power cord originally supplied with the LTV® Series ventilator, maintained in good condition and connected to a properly wired and grounded electrical power outlet.

Do not cover the ventilator – To avoid damage to the ventilator, do not cover while operating or position relative to other objects such that the operation or performance of the ventilator may be adversely affected. Ensure that sufficient space exists around the ventilator while in use to allow free circulation of gases.

² In addition to the existing internal O₂ Inlet filter, P/N 14313, an External, In-Line Oxygen Filter (P/N 14470) is available from Pulmonetic Systems, Inc.

CAUTION

Electrostatic Discharge – The use of electrically conductive hoses and tubing is not recommended. The use of such materials may result in damage to the ventilator from electrostatic discharge.

External DC Power Source or External Battery - When connecting the LTV[®] Series ventilator to an external DC power source or external battery, use only the approved method and connectors specified in *Chapter 14 - Power and Battery Operation*.

AC Power Source - When connecting the ventilator to an AC power source, use only the approved LTV[®] AC Power Adapter.

AC Power Earth Ground Validity – If the validity of the AC power earth ground connection is in doubt, use the internal battery, an external battery, or an external DC power source to operate the LTV[®] Series ventilator.

Fuse Fire Hazard – Replacement of existing fuses with fuses with different voltage or electrical current ratings may cause a fire.

Storage Temperature - Storing the LTV[®] Series ventilator at temperatures above 60°C (140°F) for long periods can damage the internal battery and cause expected battery duration to degrade.

Patient Assist Call Connector – Do not apply more than 25V rms or 32VDC to the Patient Assist Call connector.

Ventilator Checkout Tests - LTV[®] Series ventilator Checkout tests must be performed before initial use of the ventilator. Rerun the tests whenever a question about the ventilator's operation arises.

Release Button - To avoid damaging the ventilator or the power connector, push the release button on the connector before removing it from the ventilator power port or the power port pigtail connector.

ATTENTION

Stérilisation du ventilateur - Afin d'éviter des dommages irréparables au ventilateur de la série LTV®, ne tentez pas de stériliser ce dernier.

Produits de nettoyage - Afin d'éviter d'endommager les composants plastiques et le panneau frontal du ventilateur, n'utilisez pas des produits de nettoyage contenant : chlorure d'ammonium, composés de chlorure, plus de 2% de glutaraldéhyde, ou phénol.

Immersion du ventilateur - Ne pas immerger le ventilateur dans des liquides, incluant les produits stérilisants.

Composants réutilisables du circuit du patient – Pour éviter la dégradation des composants réutilisables du circuit du patient, ne dépassez pas les limites suivantes:

- 50 cycles de nettoyage ou 1 an (le premier des deux prévalant)

Autoclave à vapeur:

- Pression : 20 lb/po²
- Température : 275°F (135°C)
- Durée : 6 minutes

Agent de stérilisation liquide:

- L'utilisation d'agents liquide contenant plus de 2% de glutaraldéhyde.

Pasteurisation:

- Un cycle avec détergent à l'eau tiède pendant 30 minutes et à l'eau chaude à 165°F (74°C) pendant 30 minutes.
- Séchage dans un séchoir stérile pendant plus de 1 heure ou à 140°F (59°C).

Gaz (ETO):

- Température : 131°F (55°C)

Ports de pression différentielle - Une source de gaz à débit faible (moins de 10 ppm) doit être utilisée pour le nettoyage des fluides et de débris des ports de pression différentielle.

Nettoyage de la soupape d'expiration - Ne pas asperger une solution nettoyante dans la soupape d'expiration.

Installation de la soupape d'expiration - Après le nettoyage, installez la soupape d'expiration dans le circuit du patient de sorte que les lignes de détection soient alignées vers le haut pendant l'opération.

Entretien de la soupape d'expiration - La soupape d'expiration est une pièce fragile et peut être endommagée si :

- Des précautions ne sont pas prises lors de sa manipulation ou de son nettoyage.
- Des instruments de nettoyage ou des corps étrangers sont insérés dans celle-ci.
- Des pistolets de gaz à haute-pression sont utilisés pour l'assécher.

Nettoyage du panneau frontal - Ne pas asperger des solutions nettoyantes ou les laisser s'écouler sur le panneau frontal.

Entretien des filtres bactériens - Les filtres bactériens ne devraient pas être immergés dans un liquide. Un autoclave à vapeur devrait être utilisé pour le nettoyage des filtres bactériens.

ATTENTION

Filtres mouillés ou humides - Ne pas installer des filtres mouillés ou humides dans les ventilateurs de la série LTV[®]. Cela pourrait endommager le ventilateur.

Contamination de la réserve d'oxygène — La précision de la capacité d'alimentation en oxygène des ventilateurs LTV[®] peut être compromise par la présence de corps étrangers dans le système d'alimentation en oxygène. Afin de diminuer le risque de présence d'agents contaminants atmosphériques dans le ventilateur, assurez-vous que la réserve d'oxygène reliée au ventilateur est propre et filtrée de manière adéquate³, et que le bouchon de l'orifice d'alimentation en oxygène est correctement installé à chaque fois que le ventilateur n'est pas relié à une source d'oxygène externe.

Conduites de détection – N'enlevez pas les conduites de détection qui se trouvent sur les divisions en Y du circuit du patient.

Allume-cigare et prises de courant – L'allume-cigare et les prises de courant sont habituellement câblés de façon à obtenir un contact central positif et un contact du manchon à la terre. Le branchement du ventilateur dans une prise qui n'est pas câblée adéquatement aura pour effet de faire sauter le fusible de l'adaptateur et pourrait endommager l'adaptateur ou le ventilateur.

Puissance nominale des prises d'allume-cigare – Le branchement d'un ventilateur à une prise d'allume-cigare qui ne possède pas la tension suffisante (moins de 20 ampères) peut faire griller un fusible de l'automobile, causant ainsi l'arrêt du ventilateur et éventuellement, celui d'autres accessoires de l'automobile.

Adaptateur pour allume-cigare – Ne faites pas fonctionner le ventilateur à l'aide de l'adaptateur pour allume-cigare lorsque vous démarrez le véhicule ou lorsque vous faites une connexion provisoire de la batterie d'un véhicule. Vous pourriez ainsi endommager le ventilateur.

Embout adaptateur pour allume-cigarette d'automobile - Après l'utilisation, débrancher l'adaptateur pour allume-cigarette d'automobile avec précaution car son embout peut être chaud.

Prise d'allume-cigare d'automobile – Selon la condition de la batterie de l'automobile, si le moteur est coupé, démarré ou est en marche, les prises d'allume-cigare d'une automobile peut générer des niveaux de tension variés (sur certains modèles, la prise ne fonctionne que si le moteur est en marche). Vérifier la source d'alimentation utilisée par le ventilateur indiquée par la DEL **EXTERNAL POWER** du ventilateur.

Alarme à distance – Assurez-vous toujours que l'alarme à distance indique de façon adéquate les alarmes du ventilateur LTV[®] avant d'utiliser le ventilateur.

Alarme à distance – Suivez toujours les exigences d'utilisation et d'entretien du fabricant de l'alarme à distance afin d'assurer le fonctionnement adéquat de l'appareil.

Bloc-piles externe – Le bloc-piles externe ne doit être branché qu'aux ventilateurs de la série LTV[®] à l'aide du câble pour piles externes de Pulmonetic Systems (N^o pièce 10802). Ce câble est précâblé et ses terminaisons assurent une connexion sécuritaire entre le bloc-piles externe et le ventilateur.

³ En plus du filtre interne de l'orifice d'alimentation en oxygène, dont le numéro de pièce est 14313, Pulmonetic Systems, Inc. propose un filtre à oxygène externe, de numéro de pièce 14470.

ATTENTION

Mise électrique à la terre - En cas de perte de la mise électrique à la terre de protection, toutes les pièces conductrices peuvent transmettre un choc électrique. Pour éviter un choc électrique, n'utilisez que le cordon d'alimentation d'origine non modifié fourni avec les ventilateurs de la série LTV[®], maintenus en bonne condition, et branchés à une prise adéquatement câblée et mise à la terre.

Ne recouvrez pas le ventilateur – En vue d'éviter le risque de dommages du ventilateur, ne le recouvrez pas pendant son fonctionnement ou ne le positionnez pas en relation avec d'autres objets de sorte que le fonctionnement ou le rendement du ventilateur puisse en être négativement affecté. Assurez-vous qu'un espace suffisant existe autour du ventilateur pendant son utilisation afin de permettre une bonne circulation des gaz.

Choc électrostatique – L'utilisation de tuyaux et de tubes conductibles n'est pas recommandée. L'utilisation de ces matériaux risque de causer une décharge électrostatique qui endommagerait le ventilateur.

Source de courant continu ou pile externe - Lorsque vous branchez les ventilateurs de la série LTV[®] sur une source de courant continu ou sur une pile externe, utilisez seulement les méthodes et les connecteurs approuvés spécifiés au chapitre 14 - Alimentation et opération avec pile.

Source d'alimentation c.a. - Lorsque vous branchez le ventilateur sur une source d'alimentation c.a., utilisez l'adaptateur c.a. LTV[®] approuvé.

Validité de la mise à la terre de l'alimentation c.a. - Si vous doutez de la validité de la mise à la terre de l'alimentation c.a., utilisez la pile interne, une pile externe ou une source externe de courant continu, pour opérer le ventilateur de la série LTV[®].

Danger d'incendie des fusibles - Le remplacement des fusibles existants par des fusibles de type, d'ampérage et de courant électrique différent peut causer un incendie.

Température d'entreposage - L'entreposage du ventilateur de la série LTV[®] à des températures supérieures à 60° C (140° F) durant des périodes prolongées peut endommager la pile interne et causer l'usure prématurée de la pile.









Connecteur d'appel d'aide aux patients - Ne mettez pas plus de 25 V efficace ou 32 V c.c. au connecteur d'appel d'aide aux patients.

Tests de vérification du ventilateur - Les tests de vérification du ventilateur doivent être effectués avant de relier le patient au ventilateur. Effectuez les tests lors de doutes relativement à l'opération adéquate du ventilateur.

Bouton de déclenchement – Pour éviter d'endommager le ventilateur ou le connecteur d'alimentation, appuyer sur le bouton de déclenchement situé sur le connecteur avant de le retirer du port d'alimentation du ventilateur ou du raccord de queue de cochon du port d'alimentation.

Ne recouvrez pas le ventilateur – Afin d'éviter tout risque de dommages au ventilateur, ne le recouvrez pas pendant son fonctionnement et positionnez-le de manière à ce que son fonctionnement ou son rendement ne puisse être gêné par d'autres objets. Assurez-vous qu'un espace suffisant existe autour du ventilateur pendant son utilisation afin de permettre une bonne circulation des gaz.

Symbols

Symbol	Compliance ⁴	Title	Application
	ISO 3864 (Prev. IEC 348) Symbol No.B.3.1	Caution (refer to accompanying documents)	Used to direct the user to the instruction manual where it is necessary to follow certain specified instructions where safety is involved.
	IEC 417 Symbol No. 417-IEC-5016	Fuse	To indicate the fuse boxes, for example, and their location.
	IEC 417 Symbol No. 417-IEC-5035	Output	To identify an output terminal when it is necessary to distinguish between inputs and outputs.
	IEC 417 Symbol No. 417-IEC-5019	Protective earth (ground)	To identify any terminal which is intended for connection to an external protective conductor for protection against electric shock in case of a fault or the terminal of a protective earth (ground) electrode.
	IEC 417 Symbol No. 417-IEC-5333	Type BF equipment.	To mark a type BF equipment complying with IEC Publication 601.
	IEC 417 Symbol No. 417-IEC-5031	Direct Current	To indicate on the rating plate that the equipment is suitable for direct current only; to identify relevant terminals.
	IEC 417 Symbol No. 417-IEC-5032	Alternating current	To indicate on the rating plate that the equipment is suitable for alternating current only; to identify relevant terminals.
	IEC 417 Symbol No. 417-IEC-5172	Class II equipment	To identify equipment meeting safety requirements specified for Class II equipment.
	IEC 60417 Symbol No. 5182	Sound; audio	Used to identify controls or terminals related to audio signals.

⁴ Reference IEC Medical Electrical Equipment, 2nd. Edition 1988

Chapter 2 - VENTILATOR OVERVIEW

The LTV[®] Series ventilator is a lightweight, high performance ventilator that is designed to provide the maximum functionality in the smallest possible package. The LTV[®] Series ventilator provides the following features:

- High performance ventilation in a small lightweight package (10" x 12" x 3", 13.4 lbs).
- Turbine technology allows the LTV[®] Series ventilator to operate without an external compressed gas source.
- CPAP⁵, SIMV⁶, Control, Assist / Control and Apnea Backup ventilation modes.
- NPPV⁷ mode ventilation, providing an alarm package suitable for mask ventilation of patients that do not require life support ventilation.
- Volume Control, Pressure Control (optional) and Pressure Support ventilation.
- Variable alarm settings including High Peak Pressure, Low Peak Pressure, Low Minute Volume, Apnea, High Breath Rate, and High PEEP.
- Oxygen Blending from a High-Pressure Oxygen source, Low-Pressure Oxygen Bleed-in, O₂ Flush, and O₂ Cylinder Duration Monitoring on the LTV[®] 1000, and Low-pressure Oxygen Bleed-in on the LTV[®] 950 and 900.
- Lockable front panel controls.
- Monitors for Breath Rate (f), I:E Ratio, MAP, Minute Ventilation (VE), PEEP, PIP and Tidal Volume (Vte).
- Real-time patient circuit pressure display with Peak Inspiratory Pressure indicator.
- Variable termination conditions for Pressure Support breaths, including maximum inspiratory time termination and percentage of peak flow.
- Selectable Percentage of Peak Flow termination for Pressure Control breaths.
- Leak Compensation to improve triggering when a circuit leak is present.
- Single or dual tone output capabilities.
- Operation from a variety of power sources including AC power, internal battery and external DC power sources.

Intended Use

The LTV[®] Series ventilator is a restricted medical device designed for use by adults and pediatrics weighing a minimum of 5 kg (11 lbs), needing Positive Pressure ventilation (delivered invasively or non-invasively). It is:

- Suitable for service in institutional, homecare and transport settings as a source of continuous or intermittent ventilatory support.
- Intended for operation only by Respiratory Therapists or other properly trained and qualified personnel under the direction of a physician and in accordance with applicable state laws and regulations.
- Pulmonetic Systems Inc. does not recommend that the LTV[®] Series ventilator be used outside of its intended use.

⁵ Continuous Positive Pressure Ventilation

⁶ Synchronized Intermittent Mandatory Ventilation

⁷ Non-invasive Positive Pressure Ventilation

Power/Supplies Required

To operate the LTV[®] Series ventilator, you will need the following:

- Power source: Pulmonetic Systems P/N 10537, 110V or 220V AC power source, or 11V to 15V DC power source. This may be an external battery or a DC power system⁸.
- Oxygen supply: High-pressure oxygen source providing between 40 PSIG and 80 PSIG, or Low-flow, low-pressure oxygen source providing less than 10 PSIG.

WARNING

Untrained Personnel – Only properly trained personnel should operate the ventilator. The LTV[®] Series ventilator is a restricted medical device designed for use by Respiratory Therapists or other properly trained and qualified personnel under the direction of a physician and in accordance with applicable state laws and regulations.

Patient Monitoring - Patients who are dependent on a ventilator should be constantly monitored by qualified personnel. Such personnel should be prepared to address equipment malfunctions and circumstances where equipment becomes inoperative. An alternative method of ventilation should be available for all patients dependent on the ventilator, and qualified personnel should be fully familiar with emergency ventilation procedures.

AVERTISSEMENT

Personnel non qualifié - Seul le personnel qualifié doit opérer le ventilateur. Le ventilateur de la série LTV[®] est un dispositif médical restreint conçu pour être utilisé par les inhalothérapeutes ou autres personnes qualifiées, et par le personnel qualifié sous la supervision d'un médecin et en conformité avec les lois et règlements applicables.

Surveillance du patient – Un personnel qualifié doit constamment surveiller les patients qui sont reliés à un ventilateur. Le personnel doit être en mesure de s'occuper des déficiences de fonctionnement de l'équipement ainsi que des circonstances où ce dernier devient inopérant. Une forme de ventilation alternative doit être disponible à tous les patients reliés au ventilateur et le personnel qualifié devrait être pleinement familier avec les procédures de ventilation d'urgence.

⁸ Airline carriers typically allow only dry cell batteries on board aircraft. However, some airlines may allow an electrical cord to be plugged in if arranged in advance. Pulmonetic Systems recommends checking with the intended carrier well in advance before traveling.

Information/Assistance

For additional information or troubleshooting assistance concerning the operation of the LTV® Series ventilators, contact a certified Pulmonetic Systems' service technician or:

Pulmonetic Systems, Inc.

17400 Medina Rd., Suite 100
Minneapolis, Minnesota 55447-1341
Phone: (763) 398-8300
Customer Care Center: (800) 754-1914
Fax: (763) 398-8400
E-mail: info@pulmonetic.com
Website: <http://www.pulmonetic.com>

Chapter 3 - BREATH TYPES

This chapter contains information regarding the breath types available on the LTV® Series ventilator. It covers how breaths are initiated, limited and cycled, and when each type of breath is given.

The following terms are used in discussing how breaths are given:

- Initiate** What causes a breath to be given. Breaths may be initiated by a patient trigger, a push of the manual breath button, or by the ventilator based on the set breath rate and ventilation mode.
- Limit** How the breath is controlled. Breaths may be limited to a maximum circuit pressure or flow.
- Cycle** What causes the breath to be cycled from the inspiratory phase to the exhalation phase. Breaths may be cycled by the ventilator when a set time or delivered volume has been reached, or when an alarm condition such as a high pressure limit has been reached. Spontaneous breaths are terminated when the flow based on patient demand decreases to 10% of the maximum flow delivered during the breath, or below 3 Lpm.

Breath Types

Breaths are defined by how they are initiated, limited and cycled. The breath types are Machine, Assist, and Patient.

	<u>Machine</u>	<u>Assist</u>	<u>Patient</u> ⁹
Initiated By -	Ventilator	Patient	Patient
Limited By -	Ventilator	Ventilator	Ventilator
Cycled By -	Ventilator	Ventilator	Patient

Breaths may be given in any of the following forms: Volume Control, Pressure Control, Pressure Support and Spontaneous. These breaths are given as described in the sections below.

In addition, the following parameters apply to all breaths:

- The Minimum Inspiratory Time is 300 ms.
- The Minimum Exhalation Time is 346 ms.
- When patient triggers are enabled, triggers are detected during exhalation after the Minimum Exhalation Time has expired.

⁹ Pressure Support or Spontaneous

Volume Control Breaths

For Volume Control breaths, the set Tidal Volume is delivered over the set Inspiratory Time and flow is delivered in a decelerating taper flow waveform. Peak flow is calculated based on the Tidal Volume and Inspiratory Time and the final flow is 50% of the peak flow. Volume breaths may be machine or assist type breaths.

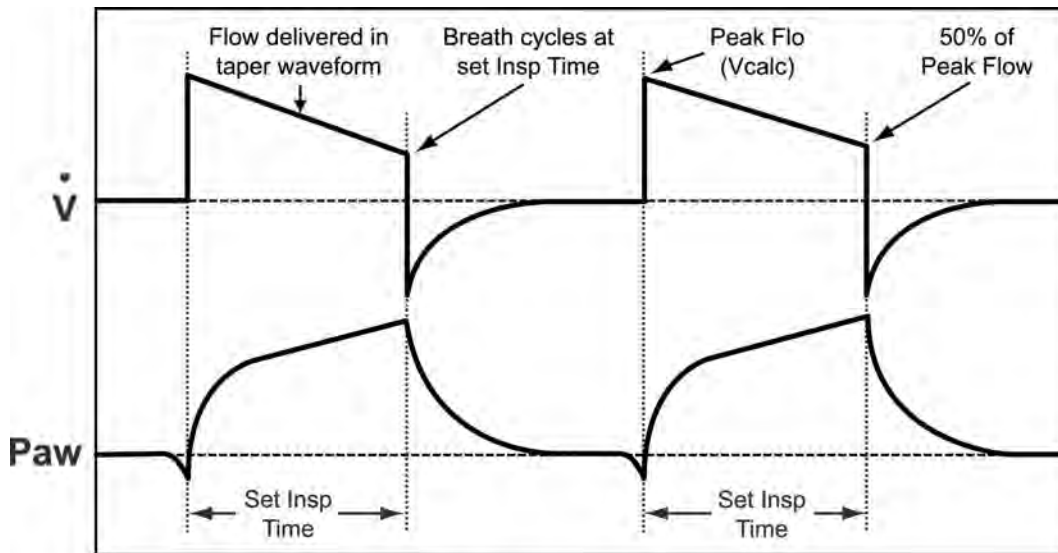

Volume Control Breaths

When the combination of inspiratory time and tidal volume result in an initial flow of <20 Lpm, the final flow remains at 10 lpm and the waveform is flattened.

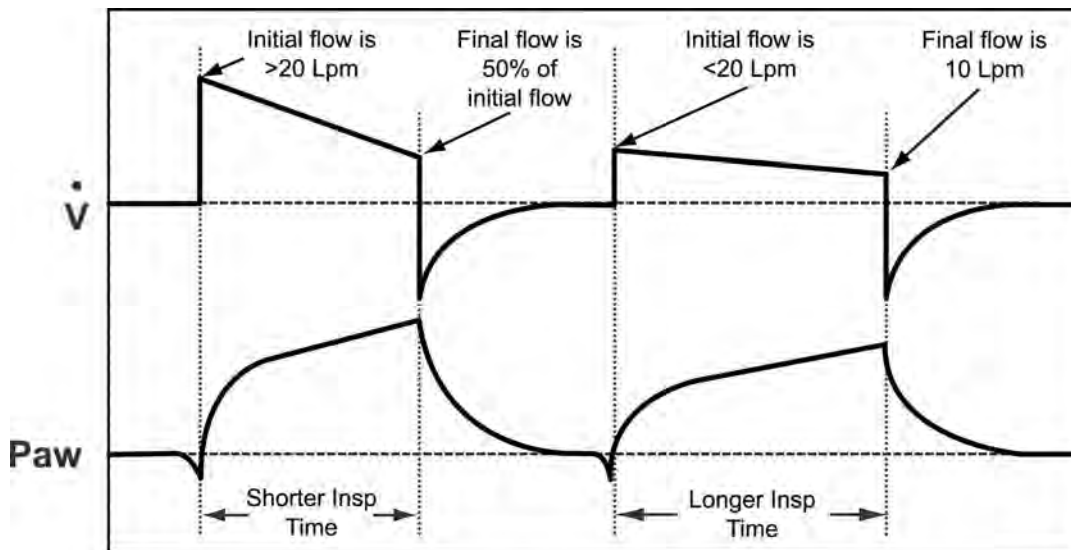

Volume Control Breaths

Pressure Control Breaths

For Pressure Control breaths¹⁰, flow is delivered to elevate the circuit pressure to the Pressure Control setting and maintain it at that pressure for the set Inspiratory Time. Pressure Control breaths may be machine or assist type breaths.

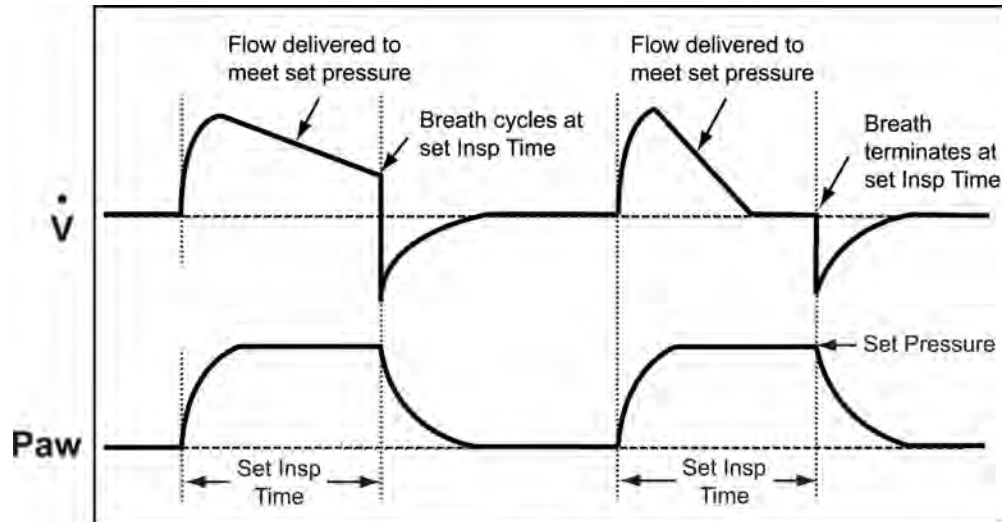

Pressure Control Breaths

Shown with example flow patterns for two different patient conditions

Adjusting the Rise Time Profile changes the flow and pressure waveforms for Pressure Control breaths.

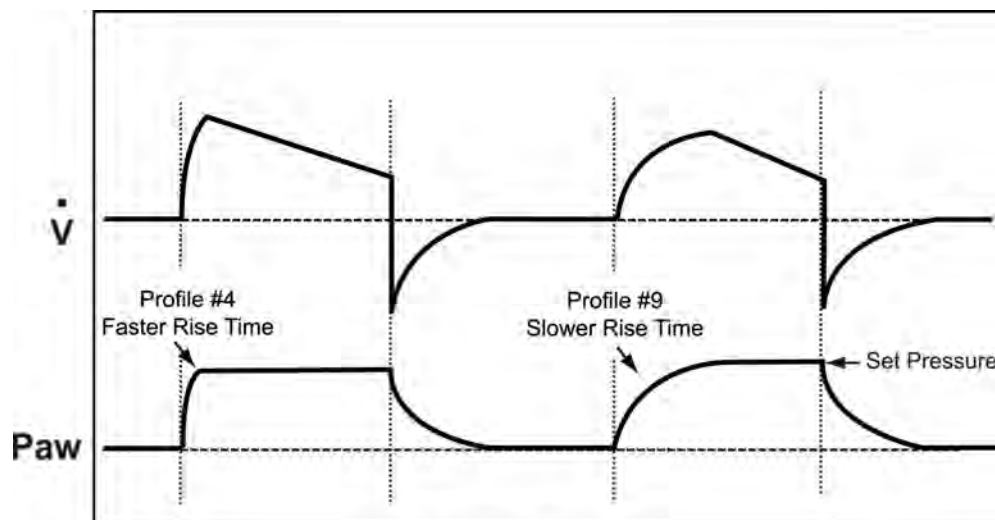

Adjusting Rise Time on Pressure Control Breaths

Pressure Control Breaths (cont)

Pressure Control breaths have an optional flow termination criteria. If PC Flow Termination is on Pressure Control breaths may be time or flow terminated. If the flow drops to the set FLOW TERM level before the inspiratory time is completed, the inspiration is cycled.

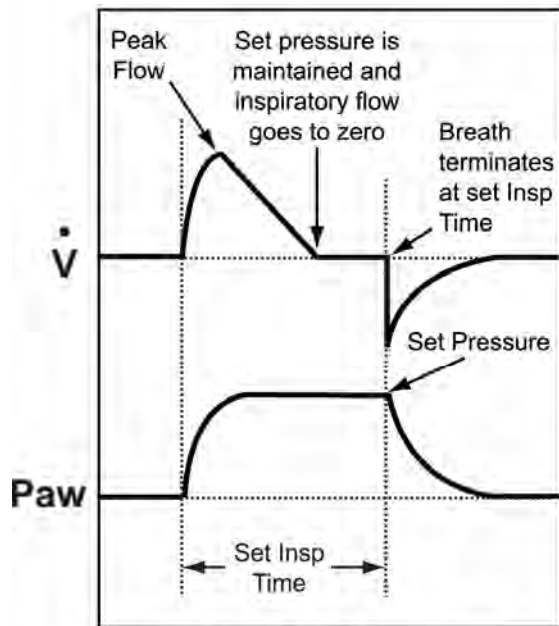

PC FLOW TERM set to OFF

Pressure Control Breath terminates normally

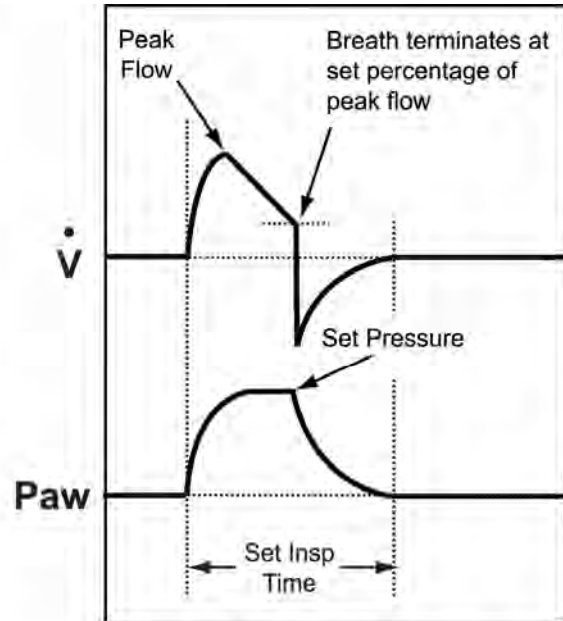

PC FLOW TERM set to ON

Pressure Control Breath terminates at the same Percentage of Peak Flow as Pressure Support breaths

¹⁰ Pressure Control and Pressure Support breaths do not compensate for PEEP. Delivered pressure is controlled by the Pressure Control setting and is not affected by the PEEP setting. i.e.; A Pressure Control setting of 20cmH₂O and a PEEP setting of 10cmH₂O results in a maximum delivered pressure of 20cmH₂O.

Pressure Support Breaths

For Pressure Support breaths, flow is delivered to elevate the circuit pressure to the Pressure Support setting and maintain it at that pressure until the flow drops below a variable percentage of the peak flow. Pressure Support breaths may also be cycled by a variable time limit, or by exceeding 2 breath periods. Pressure support breaths are patient type breaths.

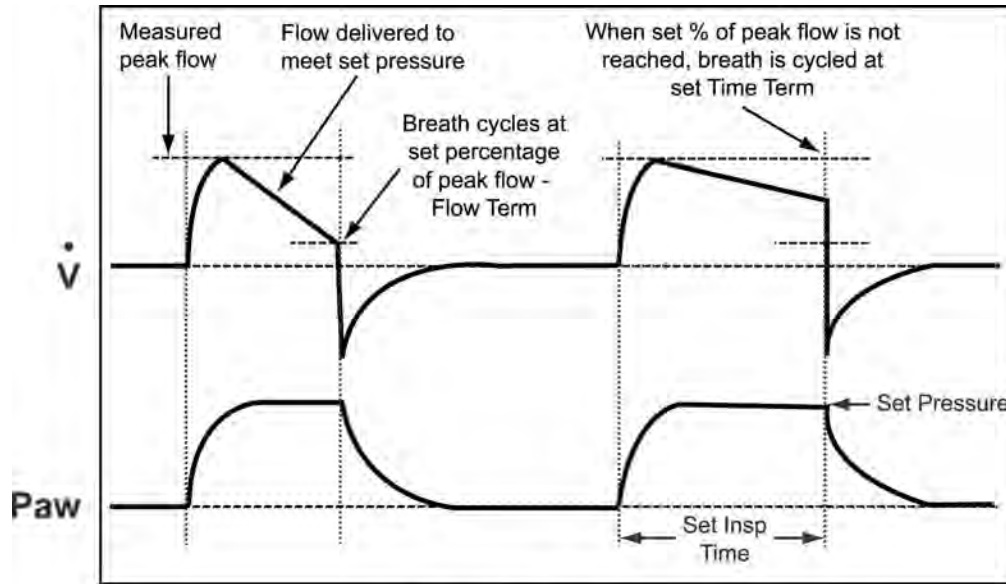

Pressure Support Breaths

For some patients, it may be useful to adjust the variable flow termination percentage. Adjusting the FLOW TERM setting between 10% and 40% will change the length, volume and comfort of the inspiration.

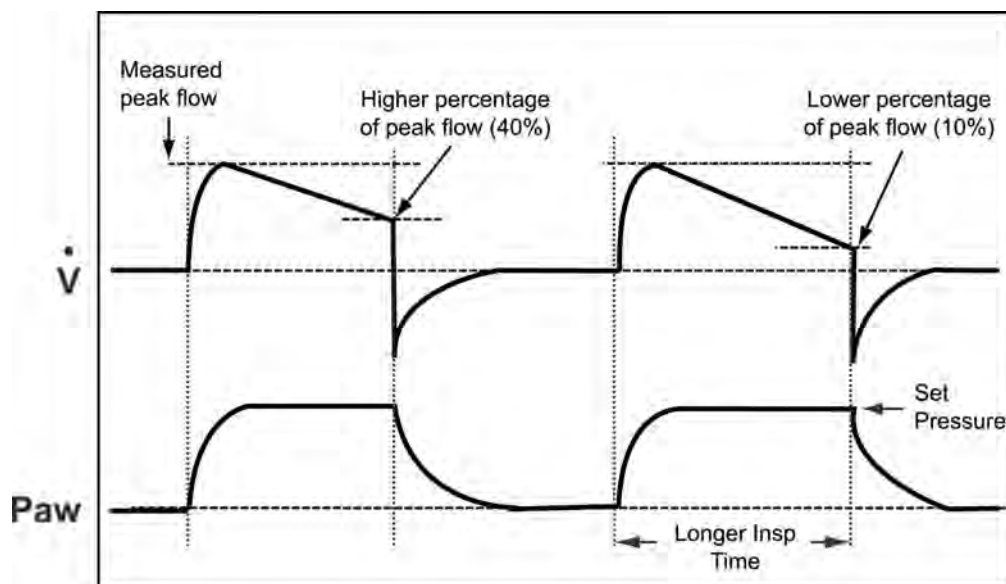

Adjusting Flow Term on Pressure Support Breaths

Spontaneous Breaths

For Spontaneous breaths, flow is delivered to meet patient demand and maintain the circuit pressure at the measured PEEP from the previous breath. The breath is cycled when the flow drops below 10% of the maximum flow delivered during the breath, or below 3 lpm. Spontaneous breaths may also be terminated by exceeding 2 breath periods. Spontaneous breaths are patient type breaths.

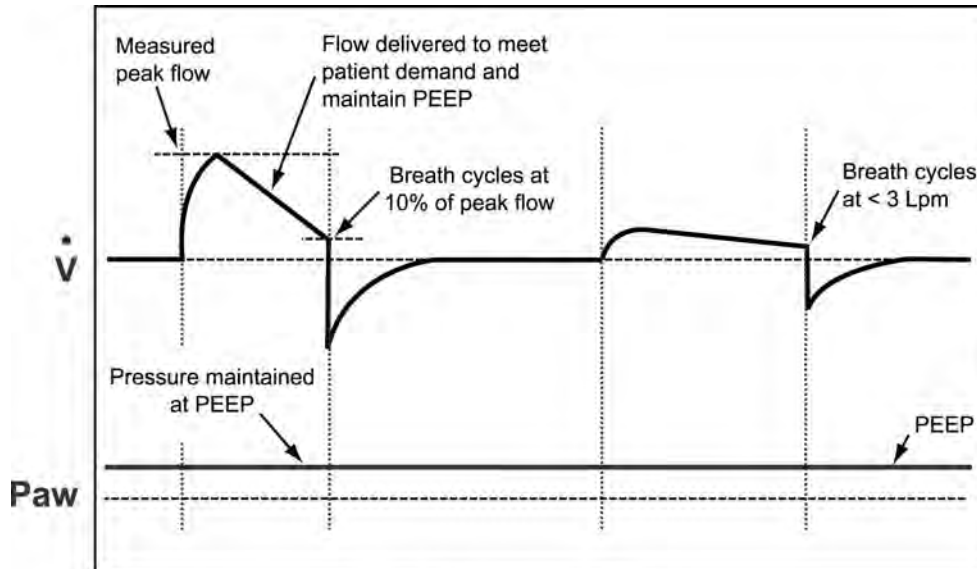

Spontaneous Breaths

Shown with example flow for two different patient conditions

⚠ WARNING

Accuracy of PEEP setting - Variations in the patient's breathing pattern and/or leaks in the patient circuit (including leaks around the tracheostomy tube cuff) can affect PEEP. PSI recommends that the clinician set the PEEP to the prescribed level on a test lung while observing the PEEP value in the LTV display window. The clinician should also periodically monitor the PEEP value in the LTV display window. Using an inaccurate PEEP setting due to a patient leak can result in less than prescribed PEEP or undesirable increases in patient circuit pressure when the patient circuit leak changes.

⚠ AVERTISSEMENT

Exactitude du paramètre PEP – Les écarts dans le mode de respiration du patient et/ou les fuites du circuit du patient (y compris les fuites autour du ballonnet pour canule de trachéostomie) peuvent affecter le PEP. Des études et investigations préliminaires recommandent que le clinicien définisse le PEP au niveau prescrit sur un poumon d'essai tout en observant la valeur PEP de l'écran graphique LTV. Le clinicien doit par ailleurs surveiller de façon périodique la valeur PEP de l'écran graphique LTV. L'utilisation d'un paramètre PEP inapproprié en raison d'une fuite de patient peut potentiellement résulter en un paramètre inférieur au paramètre PEP prescrit ou en une augmentation indésirable de la pression du circuit du patient lorsque la fuite du circuit du patient change

Chapter 4 - VENTILATION MODES

The LTV® Series ventilator provides the following modes of ventilation:

- Control
- Assist/Control
- SIMV - Synchronized Intermittent Mandatory Ventilation
- CPAP - Continuous Positive Airway Pressure
- Apnea Backup Ventilation
- NPPV - Non-Invasive Positive Pressure Ventilation

Each of these modes is described below.

Control Mode

Control mode ventilation is selected when **Assist / Control** is selected and Sensitivity is set to dashes “- - -”. In Control mode, Volume or Pressure Controlled machine breaths are given at the rate specified by the Breath Rate setting and no triggered breaths are allowed.

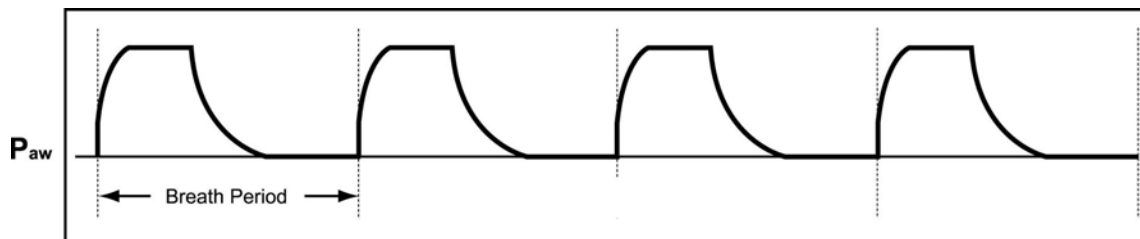

Pressure Control Machine Breaths

Assist/Control Mode

Assist / Control ventilation is selected when **Assist / Control** is selected and Sensitivity is on. In Assist / Control mode, the ventilator guarantees a minimum number of Volume or Pressure Controlled breaths are given. The patient may trigger additional Volume or Pressure Controlled assist breaths.

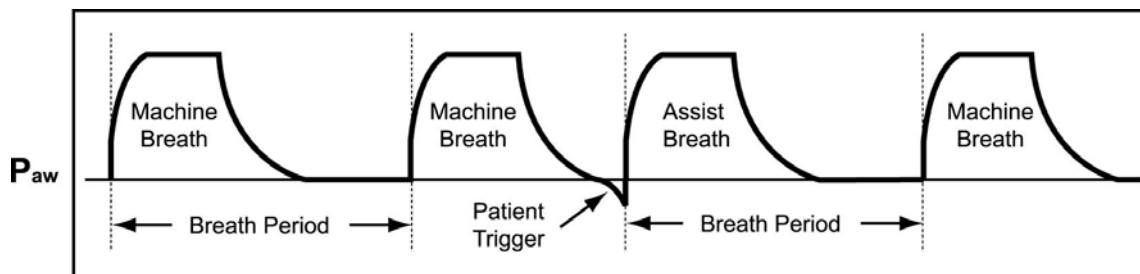

Pressure Control Machine and Assist Breaths

SIMV Mode

SIMV mode is selected when **SIMV / CPAP** is selected and Breath Rate is set between 1 and 80. In SIMV mode, machine, assist and patient breaths may be given.

For the first patient trigger detected within a breath period, an assist breath is given. For all subsequent patient triggers within the same breath period, spontaneous patient breaths are given.

At the beginning of a breath period, if no triggered breaths were given in the previous breath period, a machine breath is given. If there was a patient trigger in the previous breath cycle, the ventilator will not give a machine breath in the current breath period unless the set Apnea Interval is exceeded.

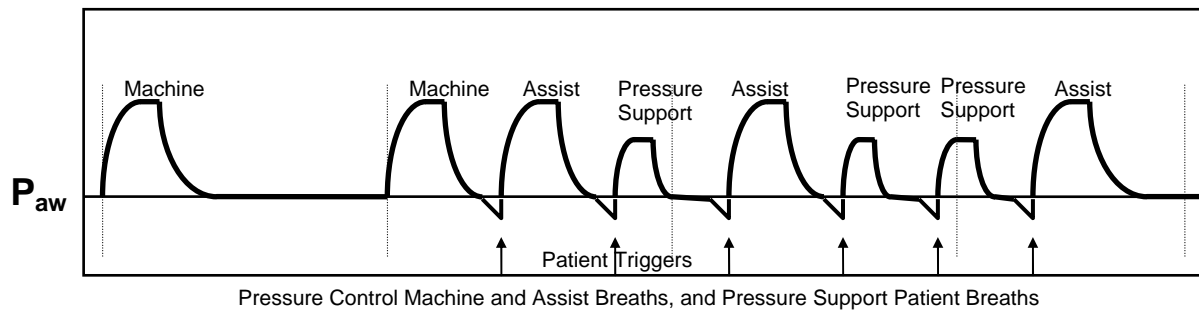

NOTE

LTV[®] ventilators provide an Apnea Backup mode of ventilation. When the set Apnea Interval (maximum time allowed between the beginning of one breath and the beginning of the next breath) is exceeded, the **APNEA** alarm is generated and the ventilator will enter Apnea Backup ventilation mode.

REMARQUE

Les ventilateurs LTV[®] procurent un mode de ventilation de secours pour l'apnée. Lorsque l'intervalle de l'apnée établi (durée maximum allouée entre le début d'une respiration et le début de la respiration suivante) est excédé, l'alarme **APNEA** est générée et le ventilateur entre en mode de ventilation de secours pour l'apnée.

CPAP Mode

CPAP mode is selected when **SIMV / CPAP** is selected and Breath Rate is set to dashes “—”. In CPAP mode, when a patient trigger is detected, a patient breath is given. Breaths will be Pressure Support or Spontaneous breaths according to the Pressure Support setting.

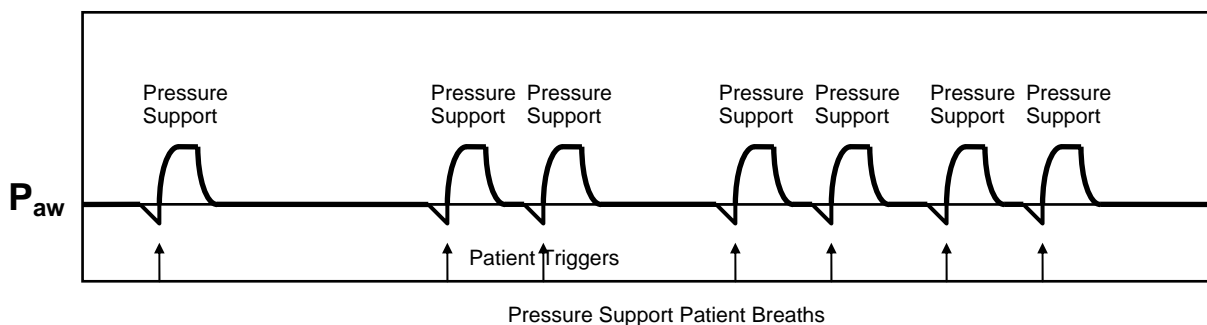

NOTE

LTV[®] ventilators provide an Apnea Backup mode of ventilation. When the set Apnea Interval (maximum time allowed between the beginning of one breath and the beginning of the next breath) is exceeded, the **APNEA** alarm is generated and the ventilator will enter Apnea Backup ventilation mode.

REMARQUE

Les ventilateurs LTV[®] procurent un mode de ventilation de secours pour l'apnée. Lorsque l'intervalle de l'apnée établi (durée maximum allouée entre le début d'une respiration et le début de la respiration suivante) est excédé, l'alarme **APNEA** est générée et le ventilateur entre en mode de ventilation de secours pour l'apnée.

Apnea Backup

The LTV[®] Series ventilator provides an Apnea Backup mode of ventilation. Apnea Backup ventilation begins when the time since the last breath start is greater than the set Apnea Interval.

When an apnea alarm occurs:

- If an inspiration is in progress, the ventilator cycles to exhalation.
- The ventilator begins Apnea Backup ventilation in the Assist/Control mode according to the current control settings. The active controls are displayed at full intensity, and all other controls are dimmed.

The breath rate for Apnea Backup mode is determined as follows:

- If the set Breath Rate is ≥ 12 bpm, the Apnea breath rate is the set Breath Rate.
- If the set Breath Rate is < 12 bpm and the set Breath Rate is not limited by other control settings, the Apnea breath rate is 12 bpm.
- If the set Breath Rate is limited to < 12 bpm, the Apnea breath rate is the highest allowed rate.

The ventilator exits Apnea Backup mode and returns to the previous mode of ventilation when the operator resets the Apnea alarm or when two consecutive patient-initiated breaths occur.

The Apnea Interval may be changed using the Extended Features menu.

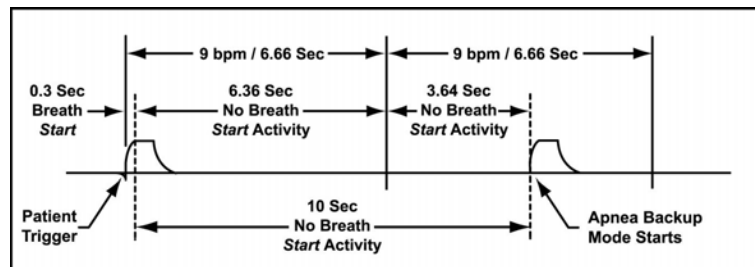

Machine Rate 9 bpm
Inspiratory Time 0.3 Seconds, Apnea Interval 10 Seconds

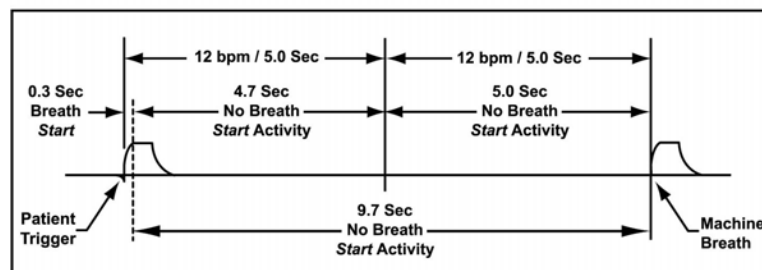

Machine Rate 12 bpm
Inspiratory Time 0.3 Seconds, Apnea Interval 10 Seconds

The ventilator provides **Non-invasive Positive Pressure Ventilation (NPPV)** as a **secondary mode that may be selected in addition to the primary ventilation mode**. When NPPV mode is selected, ventilation is delivered according to the selected mode, however, a modified set of alarms are active. **NPPV** is selected using the Extended Features menu and is not selectable from the front panel controls. While the ventilator is operating in NPPV mode, the **NPPV** LED is lit.

In NPPV mode, only the following alarms are active:

- High Pressure
- Apnea Alarm and Apnea Backup ventilation
- Sense Line Disconnect
- External Power Lost
- Internal Battery Low
- Internal Battery Empty
- Vent Inop
- Defaults

All other alarms are disabled. The displays for Low Minute Volume and Low Peak Pressure are set to dimmed dashes indicating they are not available.



WARNING

NPPV Mode - NPPV¹¹ is not a life support mode and is not suitable for patients that require life support ventilation. NPPV Mode should only be used for supplemental ventilation of non-life support patients.

NPPV Mode - When operating in NPPV¹¹ mode, many of the standard alarms are disabled. This may result in reduced ventilation accuracy should a problem occur. Carefully read *Chapter 4 - Ventilation Modes*, NPPV, before selecting this mode of operation.



AVERTISSEMENT

Mode NPPV – Le mode NPPV n'est pas un mode de maintien des fonctions vitales continu et il n'est pas approprié pour les patients qui ont besoin d'une ventilation continue pour le maintien des fonctions vitales. Le mode NPPV ne doit être utilisé que comme ventilation supplémentaire pour les patients qui ne nécessitent pas de maintien des fonctions vitales.

Mode NPPV – Lorsque l'appareil fonctionne en mode NPPV, bon nombre des alarmes standards sont désactivées. Par conséquent, si un problème survient, la précision de la ventilation pourrait diminuer. Assurez-vous de lire attentivement le chapitre 4 – Types de respiration et modes de ventilation, mode NPPV avant de choisir ce mode de fonctionnement.

¹¹ Non-Invasive Positive Pressure

Volume / Pressure Ventilation

The LTV[®] Series ventilator offers both Volume and Pressure ventilation.

When **Volume** is selected, all machine and assist breaths are Volume Control breaths. Breaths are given according to the Tidal Volume and Inspiratory Time controls. For more information on Volume Control breaths, see *Chapter 6 - Controls, Tidal Volume*.

When **Pressure** is selected, all machine and assist breaths are Pressure Control breaths. Breaths are given according to the Pressure Control and Inspiratory Time controls. For more information on Pressure Control breaths, see *Chapter 6 - Controls,*

Pressure Control.

Bias Flow

The LTV[®] Series ventilator provides a constant bias flow of 10 Lpm during exhalation to assist with patient triggering.

Chapter 5 - USING THE CONTROLS AND INDICATORS

Ventilator Controls

The following diagram shows how the front panel controls and displays are arranged. This illustration shows the LTV[®] 1000. Pressure Control ventilation, Oxygen Blending, O₂ Flush (O₂% (O₂ Flush)) and Inspiratory / Expiratory Hold are not available on some models.

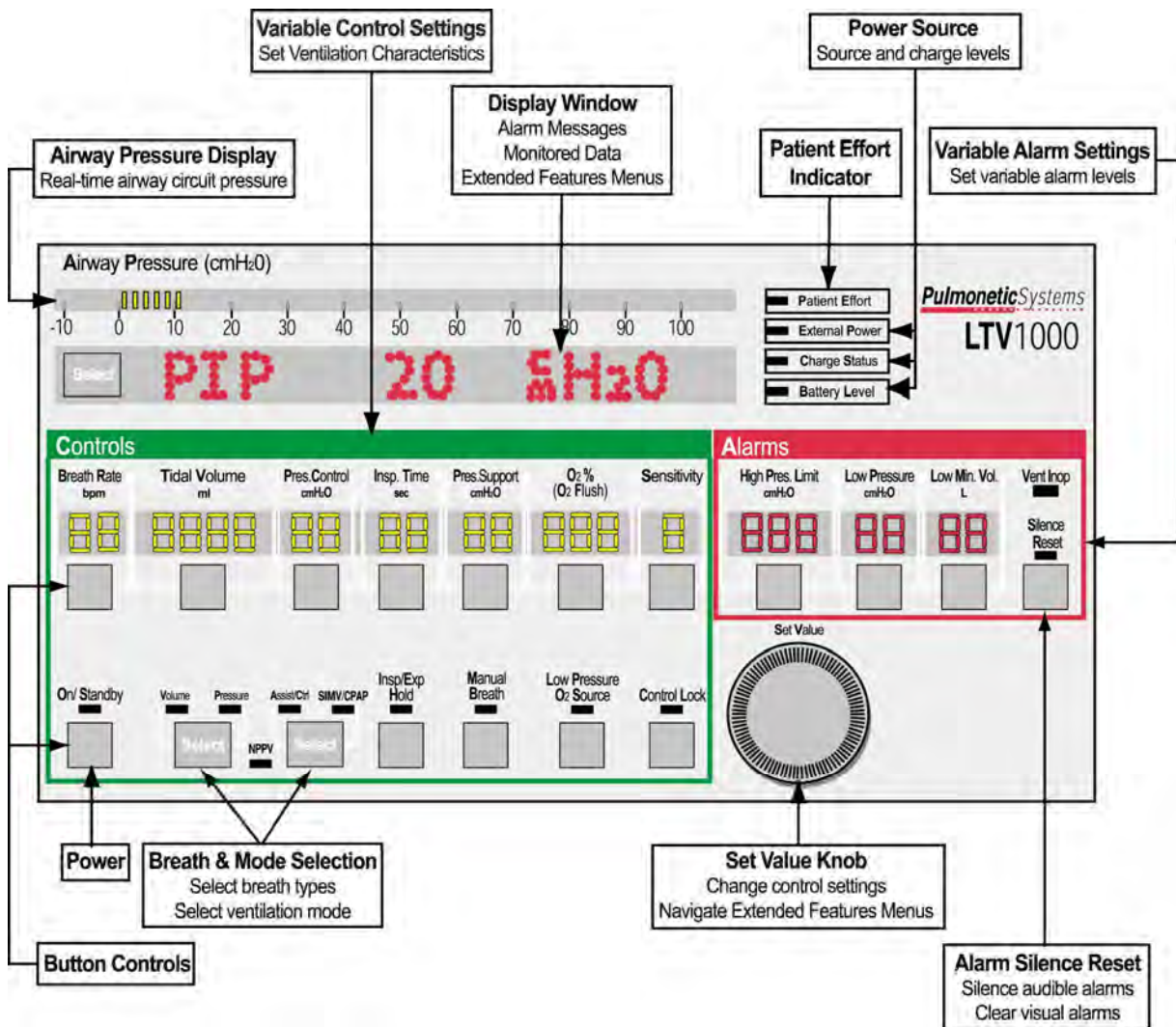

Setting a Control

There are 5 kinds of controls on the LTV® Series ventilator. They are:

Variable Controls	Controls and alarms that have front panel displays.
Buttons	Push buttons that select an option or perform a function.
Set Value Knob	Used to set control values and navigate extended features menus.
Extended Features	Ventilation options that do not have front panel controls but are available through a special menu.
Mechanical Controls	Controls such as PEEP that are set by mechanical means.

The following sections describe how to set each kind of control.

Variable Controls

To set a variable control:

- 1) Select the control by pushing the associated button. The display for the selected control will be displayed at normal brightness, but the remaining control displays will dim.
- 2) Change the control value by rotating the Set Value Knob. Rotate clockwise to increase and counter-clockwise to decrease the value. Turning the control knob slowly will change the setting by a small increment. Turning the control knob more quickly will change the setting by a larger increment.
- 3) Deselect the control by:
 - Waiting 5 seconds, or
 - Pushing the selected button again, or
 - Selecting another control, or
 - Pushing the Control Lock button

When the control is deselected, all displays will return to their normal brightness. The new control value goes into effect as soon as the control is deselected.

Buttons

Button controls do one of three things:

- Turn a feature on or off, such as Control Lock.
- Toggle between two features, such as Volume or Pressure ventilation.
- Perform a function, such as Manual Breath.

Push the button to activate the feature or change the feature state. A green LED next to the button indicates when a feature is on.

For Mode buttons, there is a second confirmation push required. To toggle between modes:

- 1) Push the mode button. The associated LED will flash for 5 seconds.
- 2) To confirm the mode change, push the mode button again while the LED is flashing. The ventilator will begin operating in the new mode.

To prevent an accidental shutdown, the ventilator requires a longer push of the On / Standby button to put the ventilator in the Standby state. To put the ventilator in Standby, push and hold the On / Standby button for 3 seconds.

Set Value Knob

Use the Set Value Knob to set control values and navigate extended features menus.

To change the setting for a variable control, select the control then turn the knob clockwise or counter-clockwise until the desired setting is reached.

For information on how to use the Set Value Knob to navigate the extended features menus, see *Chapter 10 - Extended Features*.

Extended Features

The Extended Features menus allow you to set ventilation parameters that do not have dedicated front panel controls. For information on how to use the Set Value Knob to navigate the extended features menus, see *Chapter 10 - Extended Features*.

Mechanical Controls

The ventilator PEEP setting is a manually adjusted mechanical control. Instructions for setting this control are given in *Chapter 6 - Controls*.

WARNING

Accuracy of PEEP setting - Variations in the patient's breathing pattern and/or leaks in the patient circuit (including leaks around the tracheostomy tube cuff) can affect PEEP. PSI recommends that the clinician set the PEEP to the prescribed level on a test lung while observing the PEEP value in the LTV display window. The clinician should also periodically monitor the PEEP value in the LTV display window. Using an inaccurate PEEP setting due to a patient leak can result in less than prescribed PEEP or undesirable increases in patient circuit pressure when the patient circuit leak changes.

AVERTISSEMENT

Exactitude du paramètre PEP – Les écarts dans le mode de respiration du patient et/ou les fuites du circuit du patient (y compris les fuites autour du ballonnet pour canule de trachéostomie) peuvent affecter le PEP. Des études et investigations préliminaires recommandent que le clinicien définisse le PEP au niveau prescrit sur un poumon d'essai tout en observant la valeur PEP de l'écran graphique LTV. Le clinicien doit par ailleurs surveiller de façon périodique la valeur PEP de l'écran graphique LTV. L'utilisation d'un paramètre PEP inapproprié en raison d'une fuite de patient peut potentiellement résulter en un paramètre inférieur au paramètre PEP prescrit ou en une augmentation indésirable de la pression du circuit du patient lorsque la fuite du circuit du patient change

Bright, Dim and Blank Control Displays

Variable controls will be displayed at normal or dimmed intensity, or may be blanked. A display will be displayed at normal intensity:

- When it is selected for change. All other displays will be dimmed.
- When it is active in the current ventilation mode. Dimmed displays are not active in the current mode.

NOTE

Be sure to set any controls that may be used in Apnea Backup ventilation to appropriate values. Even though these controls are dimmed, they will be used if apnea should occur.

REMARQUE

Assurez-vous de régler aux valeurs appropriées, tous les contrôles susceptibles d'être utilisés en mode ventilation de secours pour l'apnée. Même si ces contrôles sont en veilleuse, ils seront utilisés en cas d'apnée.

A display will be displayed at dimmed intensity:

- When another control is selected for change.
- When it is not active in the current ventilation mode.

A display will be blank:

- To conserve battery power while operating from battery power:
- If no button pushes or control knob activity occurs for 60 seconds, the displays are turned off. The display window, 7-segment control displays, and LEDs are turned off. Anytime an alarm occurs, or if an alarm message is already displayed, the display window will remain active. The Airway Pressure display is always active.
- To turn the displays back on, push any button or turn the control knob.
- When an option, such as oxygen blending, is not installed.
- When a control feature is not available, such as during Ventilator Checkout tests.

Flashing Controls

Variable controls and alarms will be displayed solid or flashing. A flashing control means one of the following things:

- If you are changing a control setting, and the display flashes, you have reached a limited value for the control. Control Limiting is covered later in this section.
- If an alarm display flashes, it indicates that an alarm has occurred or is occurring. See *Chapter 9 - Ventilator Alarms* for more information on this.
- If a control display flashes, it indicates a special condition such as time termination of a pressure support breath. For more information, see *Chapter 6 - Controls*.
- If the **Control Lock** LED flashes, it indicates you have tried to change the control settings while the front panel controls are locked. For more information, see *Chapter 6 - Controls, Control Lock*.

Dashes

If a control display is set to dashes “ - - - ”, it indicates that control is turned off, or is not available in the current ventilation mode.

Control Limiting

Variable control settings may be limited to less than their specified range for any of the following reasons:

- To prevent inverse I:E ratios of greater than 4:1
- To ensure a minimum inspiration time of 300 ms
- To ensure a minimum exhalation time of 346 ms
- To ensure a minimum initial flow of 10 lpm for Volume Controlled breaths
- To ensure a maximum initial flow of 100 lpm for Volume Controlled breaths

When you are updating a control and have reached a limited condition, the following things happen:

- The control stops updating and will remain displayed at the highest (or lowest) allowed value.
- The control display will flash.
- The displays for other controls involved in the limited condition will flash.

To set the control to a value outside the limited range, you will need to change the settings for other controls involved in the limit condition. For instance, if the Breath Rate is set to 12, the maximum allowed Inspiratory Time is 4.0 seconds. To set the Inspiratory Time to more than 4.0 seconds, you must first decrease the Breath Rate.

Control Locking

The front panel controls may be locked so that settings cannot be accidentally changed. When the controls are locked, the **Control Lock** LED will be on. If you try to select or change a control while the Control Lock is on, the message **LOCKED** will be displayed in the display window and the **Control Lock** LED will flash.

Two different levels of difficulty can be set for control unlocking: Easy and Hard. The Easy unlocking method should be used when only trained personnel have access to the ventilator. The Hard method should be used when children or others may have access to the ventilator and you want to prevent accidental changes to the control settings. Easy unlocking is the default and this setting is changed using the Extended Features menus¹².

To turn the Control Lock on:

- 1) Push the Control Lock button.

The **Control Lock** LED is on whenever the front panel controls are locked.

If you push a button while the controls are locked:

- 1) The **Control Lock** LED will flash.
- 2) **LOCKED** will be displayed in the display window.
- 3) The button push is ignored.

To turn the Control Lock off with Easy unlocking:

- 1) Push the Control Lock button.

To turn the Control Lock off with Hard unlocking:

- 1) Push and hold the Control Lock button for 3 seconds.

These controls are not affected by the control lock and operate even when the control lock is on: Manual Breath, Silence / Reset, Select.

Control Retention

Once a control value is set, that value will be retained in non-volatile memory¹³. The settings retained in non-volatile memory will be used when the ventilator is next powered up.

¹² See *Chapter 10 - Extended Features, Control Unlock* for more information.

¹³ Non-volatile memory is memory that is not erased when the ventilator is turned off or disconnected.

Chapter 6 - CONTROLS

This section explains how each of the LTV® Series ventilator front panel controls work.

Assist/Control / SIMV/CPAP Modes

This button toggles between **Assist/Control** and **SIMV/CPAP** modes of ventilation.

To toggle between the modes:

- 1) Push the mode button. The associated LED will flash for 5 seconds.
- 2) To confirm the mode change, push the mode button again while the LED is flashing. The ventilator will begin operating in the new mode as soon as the mode change is complete.

NOTE

When **Assist/Control** is selected, the ventilator will be in Control or Assist/Control mode, depending on the Sensitivity setting.

- If Sensitivity is set to dashes “- - -”, the ventilator will be operating in Control mode.
- If Sensitivity is set to any other value, the ventilator will be operating in Assist/Control mode.

When **SIMV/CPAP** is selected, the ventilator will be in SIMV or CPAP mode, depending on the Breath Rate setting.

- If Breath Rate is set to dashes “- -”, the ventilator will be operating in CPAP mode.
- If Breath Rate is set to any other value, the ventilator will be operating in SIMV mode.

REMARQUE

Lorsque **Aide / Contrôle** est sélectionné, le ventilateur sera en mode Contrôle ou Aide, selon le réglage de la sensibilité.

- Si la sensibilité est réglée sur Traits « - - - », le ventilateur fonctionnera en mode Contrôle.
- Si la sensibilité est réglée sur toute autre valeur, le ventilateur fonctionnera en mode Aide / Contrôle.

Lorsque le mode **SIMV / CPAP** est sélectionné, le ventilateur sera en mode SIMV ou CPAP, selon le réglage du débit respiratoire.

- Si le débit respiratoire est réglé sur Traits « - - », le ventilateur fonctionnera en mode CPAP.
- Si le débit respiratoire est réglé sur toute autre valeur, le ventilateur fonctionnera en mode SIMV.

Breath Rate

Use the Breath Rate control to establish the minimum rate of machine or assist breaths that the ventilator will deliver per minute.

To set the Breath Rate:

- 1) Push the Breath Rate button.
- 2) Change the setting using the Set Value knob.

Range: “- -”, 1 - 80 bpm

NOTE

When **SIMV/CPAP** is selected, the ventilator will be in SIMV or CPAP mode, depending on the Breath Rate setting.

- If Breath Rate is set to dashes “- -”, the ventilator will be operating in CPAP mode.
- If Breath Rate is set to any other value, the ventilator will be operating in SIMV mode.

REMARQUE

Lorsque le mode **SIMV / CPAP** est sélectionné, le ventilateur sera en mode SIMV ou CPAP, selon le réglage du débit respiratoire.

- Si le débit respiratoire est réglé sur Traits « - - », le ventilateur fonctionnera en mode CPAP.
- Si le débit respiratoire est réglé sur toute autre valeur, le ventilateur fonctionnera en mode SIMV.

Control Lock

The LTV® Series ventilator front panel controls may be locked so that settings are not accidentally changed. Two different levels of difficulty can be set for control unlocking: Easy and Hard. Easy unlocking is the default and this setting is changed using the Extended Features menus¹⁴. For more information on using the Control Lock, see *Chapter 5 - Control Locking*.

To turn the Control Lock on:

- 1) Push the Control Lock button.

The **Control Lock** LED is on whenever the front panel controls are locked.

To turn the Control Lock off with Easy unlocking:

- 1) Push the Control Lock button.

To turn the Control Lock off with Hard unlocking:

- 1) Push and hold the Control Lock button for 3 seconds.

These controls are not affected by the control lock and operate even when the control lock is on: Manual Breath, Silence / Reset, Select.

¹⁴ See *Chapter 10 - Extended Features, Control Unlock* for more information.

High Pressure Limit

Use the High Pressure Limit to establish the maximum pressure permitted the patient circuit. When this limit is reached:

- A **HIGH PRES** alarm is displayed
- The audible alarm is sounded
- Inspiration is terminated and exhalation begins

The turbine is stopped to allow the circuit pressure to evacuate when the high pressure condition persists for more than four times the set inspiratory time or more than 3.0 seconds, whichever is less.

To set the High Pressure Limit:

- 1) Push the **High Pressure Limit** button.
- 2) Change the setting using the Set Value knob.

Range: 5 - 100 cmH₂O

Inspiratory / Expiratory Hold

Pushing the **Insp/Exp** (Inspiratory/Expiratory) **Hold** control button causes the ventilator to toggle between the following messages in the display window. Each push causes the next item in sequence to be displayed:

INSP HOLD

EXP HOLD

Normal monitor display

While INSP HOLD or EXP HOLD is displayed:

- The **Insp/Exp Hold** control button LED will flash on and off.
- If the **Insp/Exp Hold** control button is not pushed within 60 seconds, the message will be removed and the LED will turn off.
- Pushing the Select, Silence / Reset or Control button will return the display to normal and the LED will stop flashing.

Inspiratory Hold

An Inspiratory Hold maneuver holds the inspiratory phase of a delivered breath for a duration sufficient to determine Δ Pres pressure and static lung compliance of the patient.

To perform the Inspiratory Hold maneuver:

- 1) Push the **Insp/Exp** (Inspiratory/Expiratory) **Hold** control button once and the display window will toggle from normal monitor display to **INSP HOLD**.
- 2) Push and hold the **Insp/Exp** (Inspiratory/Expiratory) **Hold** button during a volume inspiration.
 - The ventilator will perform an Inspiratory Hold on the next Volume breath.
 - **P Plat**¹⁵ --- will be displayed in the display window.
 - All buttons that are not lockable will operate normally.
 - All buttons that are lockable will be ignored.
- 3) Continue holding the button until the Volume inspiration is completed. During the maneuver:
 - The exhalation valve will remain closed.
 - Flow will be set to 0 LPM.
 - **P Plat xxx** will be displayed in the display window, where xxx is the real time circuit pressure.
 - The breath period will remain in inspiration phase so no breath triggers are allowed.
 - **DISC/SENSE** and **HIGH PRES** alarms will terminate the maneuver.
- 4) Release the button when the pressure setting is **P Plat** (or when 6.0 seconds elapse, whichever comes first):
 - The exhalation valve will be opened and a normal exhalation phase will begin.
 - The display will cycle every 2 seconds between **Δ Pres xxx** where xxx is the change in pressure¹⁶, **C Static xxx** where xxx is the static compliance¹⁷ and **P Plat xxx** where xxx is the plateau pressure.

NOTE

Breath period timing and apnea timing will be suspended while the maneuver is performed. As a result, the apnea alarm will not alarm during the maneuver.

REMARQUE

La synchronisation de la période de respiration et la synchronisation de l'apnée sont interrompues pendant la manœuvre. Ainsi, l'alarme d'apnée ne se déclenche pas au cours de la manœuvre.

Range:	P Plat	0 - 100 cmH ₂ O
	Δ Pres	0 - 100 cmH ₂ O
	C Static	1 – 999 ml/cmH ₂ O

¹⁵ "P Plat" is Plateau pressure reached during Inspiratory Hold maneuver.

¹⁶ Δ Pres is calculated as P Plat Pressure – PEEP measured from previous breath.

¹⁷ C Static is calculated as Set Delivered Volume / Δ Pres.

NOTE

The ventilator will not perform an Inspiratory Hold maneuver during Pressure Control, Pressure Support or Spontaneous breaths.

If the button is held during exhalation or any non-volume inspiration:

- The associated LED will be blinking.
- All buttons that are not lockable will operate normally.
- All buttons that are lockable will be ignored.

If the button is released before the inspiration is complete, the display will return to **INSP HOLD**.

Once the maneuver is completed, if any buttons are touched or an alarm occurs, the **Δ Pres**, **C Static** or **P Plat** display will be cleared.

After 60 seconds, the display will be cleared.

REMARQUE

Le ventilateur n'effectue pas une manœuvre de maintien de l'inspiration au cours du contrôle de pression, du soutien de pression et de ventilations spontanées.

Lorsque le bouton est maintenu pendant l'exhalation ou toute inspiration sans volume:

- Le LED correspondant demeure allumé en continu.
- Tous les boutons non verrouillables fonctionnent normalement.
- Tous les boutons verrouillables sont ignorés.

Lorsque le bouton est relâché avant la fin de l'inspiration, l'affichage indique **INSP HOLD**.

Au terme de la manœuvre, l'actionnement d'un bouton ou le déclenchement d'une alarme entraînent l'effacement de l'affichage **Δ Pres** ou **C Static**.

L'affichage est effacée après 60 secondes.

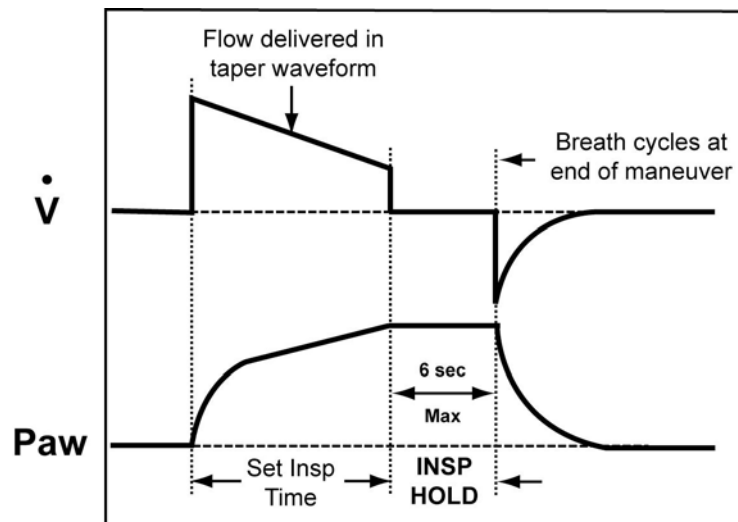

Inspiratory Hold on Volume Control Breath

Expiratory Hold

An Expiratory Hold maneuver holds the expiratory phase of a delivered breath for a duration sufficient to determine the AutoPEEP of a patient.

To perform the Expiratory Hold maneuver:

- 1) Push the **Insp/Exp** (Inspiratory/Expiratory) **Hold** button twice and the display window will toggle from normal monitor display to **EXP HOLD**.
- 2) Push and hold the **Insp/Exp** (Inspiratory/Expiratory) **Hold** button during a Volume or Pressure Control exhalation and the ventilator will perform an Expiratory Hold at the end of that exhalation.
 - Exhalation will proceed normally with the exhalation valve open and normal bias flow.
 - All buttons that are not lockable will operate normally.
 - All buttons that are lockable will be ignored.
 - The breath will remain in exhalation phase.
 - If a Patient Effort is detected, the maneuver will be terminated and the appropriate breath will be given.
 - **DISC/SENSE** and **HIGH PRES** alarms will terminate the maneuver.
- 3) Continue holding the button until **P Exp** with a numeric value is displayed, or the next breath is scheduled to begin, either due to Breath Rate or a Manual Breath button push. During the maneuver:
 - The exhalation valve will be closed.
 - Flow will be set to 0 LPM.
 - **P Exp xxx** will be displayed in the display window, where xxx is the real time circuit pressure¹⁸.
 - The breath will remain in expiration phase.
 - **DISC/SENSE** and **HIGH PRES** alarms will terminate the maneuver.
 - If a Patient Effort is detected, the maneuver will be terminated and the appropriate breath will be given.
- 4) Release the button (or when 6.0 seconds elapse, whichever comes first):
 - A normal inspiration phase will begin.
 - **AutoPEEP xxx** will be displayed where xxx is the autoPEEP¹⁸.
 - Any machine breath starts or apnea alarms that were held off will resume.

NOTE

Breath period timing and apnea timing will be suspended while the maneuver is performed. As a result, the apnea alarm will not alarm during the maneuver.

REMARQUE

La synchronisation de la période de respiration et la synchronisation de l'apnée sont interrompues pendant la manœuvre. Ainsi, l'alarme d'apnée ne se déclenche pas au cours de la manœuvre.

Range:	P Exp	0 - 100 cmH ₂ O
	AutoPEEP	0 - 100 cmH ₂ O

¹⁸ AutoPEEP is calculated as P Exp at end of Expiratory Hold maneuver minus P Exp at end of normal exhalation (monitored PEEP).

NOTE

The ventilator will not perform an Expiratory Hold maneuver during Pressure Support or Spontaneous breaths.

If the button is held during inspiration or during Pressure Support or spontaneous exhalation:

- The associated LED will be blinking.
- All buttons that are not lockable will operate normally.
- All buttons that are lockable will be ignored.

If the button is released before the expiration is complete, the display will return to **EXP HOLD**.

Once the maneuver is completed, if any buttons are touched or an alarm occurs, the **AutoPEEP** display will be cleared.

After 60 seconds, the **AutoPEEP** display will be cleared.

REMARQUE

Le ventilateur n'effectue pas une manœuvre de maintien de l'expiration au cours du soutien de pression ou de ventilations spontanées.

Lorsque le bouton est maintenu pendant l'inspiration, le soutien de pression ou des ventilations spontanées:

- Le LED correspondant demeure allumé en continu.
- Tous les boutons non verrouillables fonctionnent normalement.
- Tous les boutons verrouillables sont ignorés.

Lorsque le bouton est relâché avant la fin de l'expiration, l'affichage indique **EXP HOLD**.

Au terme de la manœuvre, l'actionnement d'un bouton ou le déclenchement d'une alarme entraînent l'effacement de l'affichage **AutoPEEP**.

L'affichage **AutoPEEP** est effacée après 60 secondes.

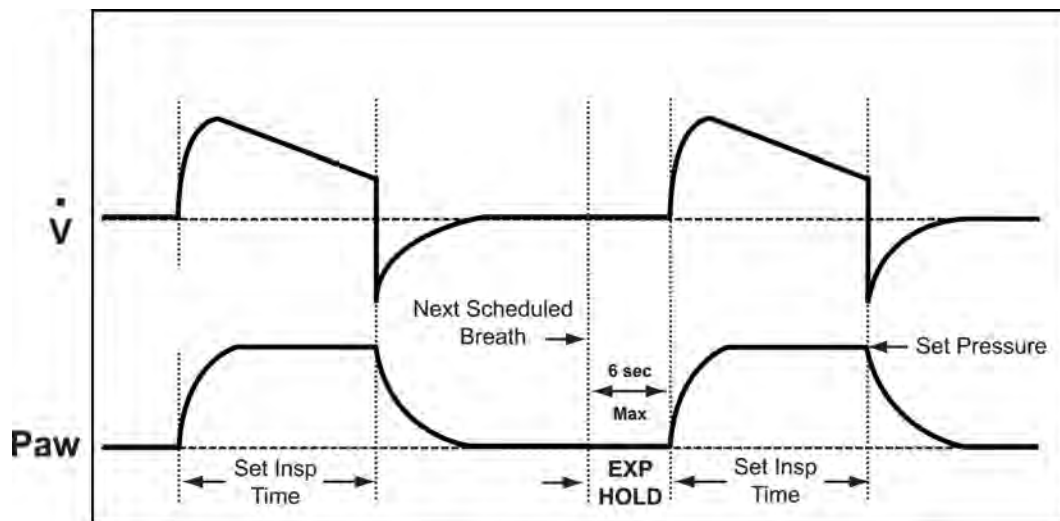

Expiratory Hold on Pressure Control Breath

Inspiratory Time

This control sets the length of the inspiratory period for Volume Controlled and Pressure Controlled breaths.

The Inspiratory Time setting, along with the Volume Control setting are used to determine the peak flow for Volume controlled breaths. While the Inspiratory Time is being updated, the Calculated Peak Flow will be displayed in the display window.

To set the Inspiratory Time:

- 1) Push the **Inspiratory Time** button.
- 2) Change the setting using the Set Value knob.

Range: 0.3 - 9.9 sec

Low Minute Volume

The Low Minute Volume alarm sets the minimum expected exhaled Minute Volume. The exhaled Minute Volume is recalculated after every breath. If the Minute Volume does not meet or exceed the Low Minute Volume setting:

- A **LOW MIN VOL** alarm is displayed
- The audible alarm is sounded

The Low Minute Volume alarm is not active in **NPPV** mode.

To set the Low Minute Volume alarm:

- 1) Push the **Low Minute Volume** button.
- 2) Change the setting using the Set Value knob.

Range: Off, 0.1 - 99 L

WARNING

Low Minute Volume Control Settings - The Low Minute Volume control should be set to its highest clinically appropriate value. If there is a clinical need to set the Low Minute Volume alarm to lower values or off ("- - -"), perform a clinical assessment to determine if an alternative monitor (i.e. a Pulse Oxymeter with an audible alarm, or a Cardio Respiratory Monitor) should be used.

AVERTISSEMENT

Réglages du contrôle de volume bas par minute - Le contrôle du volume bas par minute doit être ajusté à la plus haute valeur clinique appropriée. Si l'alarme de volume bas par minute doit être ajustée à des valeurs inférieures ou mise à l'arrêt ("- - -") pour satisfaire aux besoins cliniques, effectuer une évaluation clinique afin de déterminer si l'utilisation d'un autre moniteur (c.-à-d., sphymno-oxymètre muni d'une alarme sonore ou un moniteur cardio-respiratoire) s'avère pertinente.

Low Pressure

The Low Pressure alarm can be set to apply to All breaths or to Volume Control and Pressure Control breaths only. (For information on selecting breath types, see *Chapter 10 - Extended Features, Low Peak Pressure Alarm*.) The Low Pressure alarm establishes the minimum expected circuit pressure for the selected breath types. If the circuit pressure does not meet or exceed the Low Pressure setting:

- A **LOW PRES** alarm is displayed
- The audible alarm is sounded

The Low Pressure alarm is not active in NPPV mode.

To set the Low Pressure alarm:

- 1) Push the **Low Pressure** button.
- 2) Change the setting using the Set Value knob.

Range: “- -”, 1 - 60 cmH₂O

WARNING

Patient Circuit Accessories - The use of accessories such as Speaking Valves, Heat-Moisture Exchangers and Filters create additional patient circuit resistance and in the event of a disconnection, may impede the generation of a Low Pressure Alarm. Ensure that the Low Pressure Alarm settings accommodate these types of accessories when used in combination with patient circuits.

AVERTISSEMENT

Accessoires du circuit du patient - L'utilisation d'accessoires tels que les membranes vocales, les échangeurs thermohydriques et les filtres, produit une résistance additionnelle dans le circuit de patient et en cas de débranchement, elle risque d'empêcher la génération de l'alarme de basse pression. S'assurer que les paramètres de l'alarme de basse pression s'adaptent à ces types d'accessoires lorsqu'ils sont utilisés avec les circuits du patient.

Low Pressure O₂ Source (LTV® 1000 Only)

When selected, this option allows oxygen to be supplied from a low pressure / low flow oxygen source such as an oxygen concentrator or line mounted flow meter. Oxygen from the low pressure source is mixed with air inside the ventilator. The O₂ percent delivered to the patient is determined by the O₂ inlet flow and the total minute volume and is not regulated by the ventilator. Use the Input O₂ Flow chart (page 6-15) to determine the correct O₂ flow for the desired FIO₂.

- When the Low Pressure O₂ Source option is selected and a high O₂ pressure source is attached to the ventilator, an Automatic High O₂ Switch Over safety response¹⁹ generates a **HIGH O₂ PRES** alarm, switches the ventilator to High Pressure O₂ Source mode and sets the percentage of oxygen to be delivered in the gas flow to 21%.

When the Low Pressure O₂ Source option is not selected, a high pressure oxygen source is expected, and oxygen blending is done within the ventilator. The ventilator expects an oxygen source with a pressure of 40 - 80 PSIG. The O₂ percent delivered to the patient is determined by the O₂ % (O₂ Flush) setting on the ventilator front panel.

To toggle the state of the Low Pressure O₂ Source:

- 1) Push the **Low Pressure O₂ Source** button.
 - While the Low Pressure O₂ Source is selected, the associated LED will be on.

While Low Pressure O₂ Source is on:

- The O₂ Inlet Pressure Low alarm is inactive.
- The O₂ Pressure High alarm is set to activate at > 10 PSIG.
- The O₂ % (O₂ Flush) display will display dimmed dashes and O₂ % cannot be set.
- Oxygen inlet flow must be set to obtain the desired oxygen percentage.

WARNING

Inspired Oxygen (FIO₂) Concentration – If the patient has a variable respiratory rate, his/her minute ventilation will fluctuate. If exact concentrations of inspired oxygen (FIO₂) are required to be delivered to the patient, it is recommended that an accurate oxygen analyzer with alarms be used.

AVERTISSEMENT

Concentration d'oxygène inspiré (FIO₂) – Si la fréquence respiratoire du patient est variable, sa ventilation-minute va fluctuer. Lorsqu'une concentration exacte d'oxygène inspiré (FIO₂) est nécessaire pour une transmission au patient, il est recommandé d'utiliser un analyseur de niveau d'oxygène² précis, comportant des alarmes.

¹⁹ The Automatic High O₂ Switch Over safety response is only available on LTV®1000 ventilators.

Low Pressure O₂ Source (cont.)

NOTE

The Oxygen Inlet High Pressure Alarm at 10 PSIG is only active when Low Pressure O₂ Source is on.

REMARQUE

L'alarme de haute pression d'entrée de l'oxygène réglée sur 10 PSIG ne sera active que lorsque la source de basse pression O₂ est activée.

While Low Pressure O₂ Source is off:

- The O₂ Inlet Pressure Low alarm is set to activate at less than 35 PSIG.
- The O₂ Pressure High alarm is set to activate at greater than 85 PSIG.
- The O₂ % (O₂ Flush) may be used to set the desired percentage of oxygen.

NOTE

The Oxygen Inlet High Pressure Alarm at 85 PSIG and Oxygen Inlet Low Pressure Alarm at 35 PSIG are only active when Low Pressure O₂ Source is off and the O₂ % (O₂ Flush) setting is greater than 21%.

REMARQUE

L'alarme de haute pression d'entrée de l'oxygène réglée sur 85 PSIG, et l'alarme de basse pression d'entrée de l'oxygène réglée sur 35 PSIG ne seront actives que lorsque la source de basse pression O₂ est désactivée et que le réglage du O₂ % (Flush O₂) est supérieur à 21%.

When the Oxygen Blending option is not installed:

The Low Pressure O₂ Source button is only active when the oxygen blending option is installed. Oxygen may still be supplied through the low pressure, low flow inlet, but the Low Pressure O₂ Source button, O₂ % (O₂ Flush) control, and the Oxygen Inlet Pressure alarms are inactive.



WARNING

Disabled Oxygen Inlet Pressure Alarms - When the oxygen blending option is not installed, the Oxygen Inlet Pressure Alarms are disabled.



AVERTISSEMENT

Alarmes de pression d'entrée de l'oxygène désactivées - Lorsque l'option de mélange d'oxygène n'est pas activée, les alarmes de pression d'entrée de l'oxygène sont désactivées.

Low Pressure O₂ Source (cont)

Low Pressure O₂ Blending:

Oxygen will be applied through the low pressure, low flow inlet. Use this chart to determine the approximate O₂ flow required to deliver the desired FIO₂.

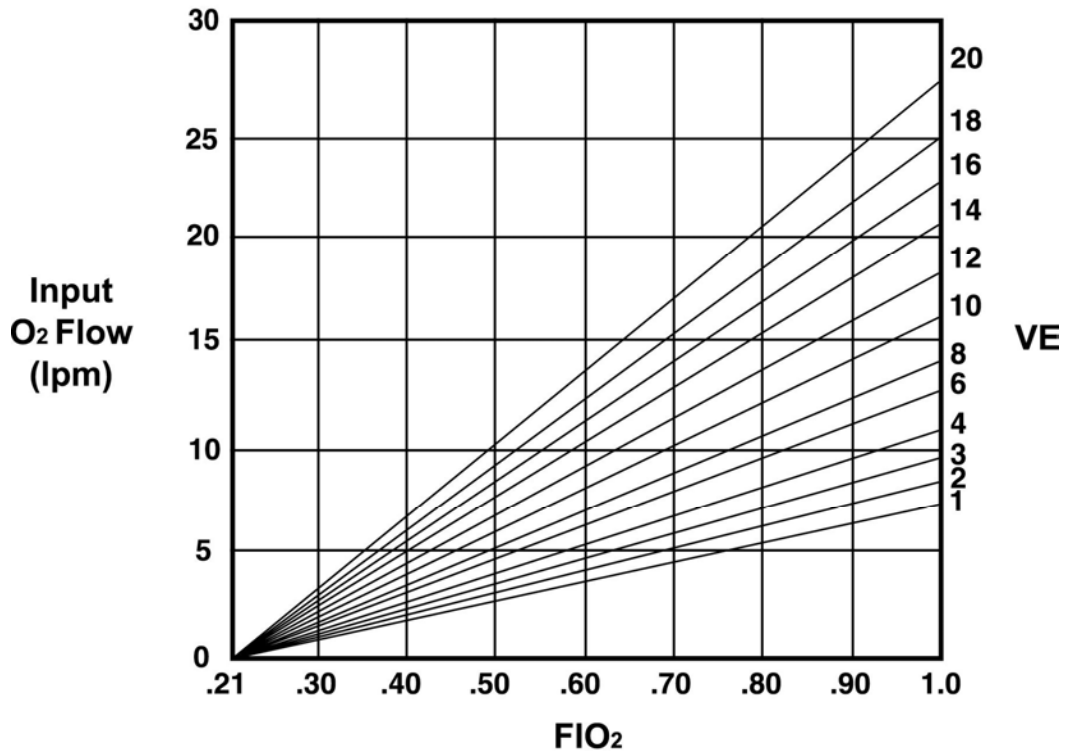

WARNING

Inspired Oxygen (FIO₂) Concentration – If the patient has a variable respiratory rate, his/her minute ventilation will fluctuate. If exact concentrations of inspired oxygen (FIO₂) are required to be delivered to the patient, it is recommended that an accurate oxygen analyzer with alarms be used.

AVERTISSEMENT

Concentration d'oxygène inspiré (FIO₂) – Si la fréquence respiratoire du patient est variable, sa ventilation-minute va fluctuer. Lorsqu'une concentration exacte d'oxygène inspiré (FIO₂) est nécessaire pour une transmission au patient, il est recommandé d'utiliser un analyseur de niveau d'oxygène précis, comportant des alarmes.

Low Pressure O₂ Source (cont.)

To determine the required O₂ input flow:

- 1) Find the desired FIO₂ (bottom of chart).
- 2) Calculate the patient's minute ventilation rate by using the following formula: Tidal volume x breath rate.
- 3) Follow the FIO₂ up to the applicable slanted VE (minute volume) line (right side of chart).
- 4) Read across horizontally to the left side of chart to the required Input O₂ Flow (lpm).

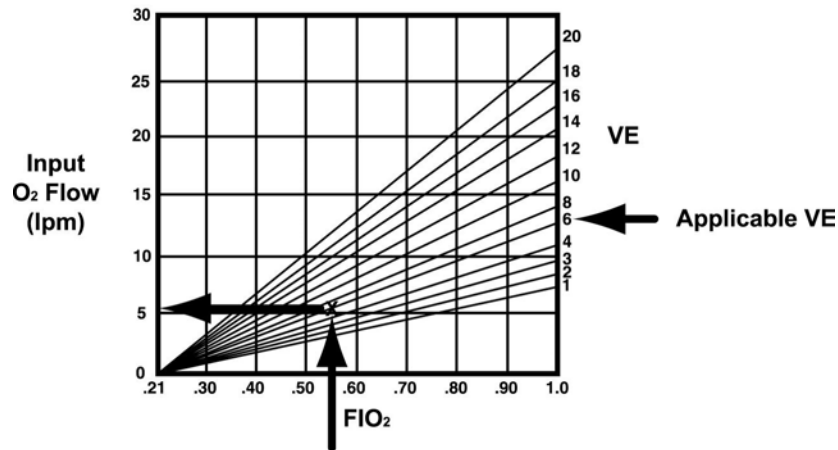

Example - To determine the required O₂ input flow

To determine the delivered O₂ concentration:

- 1) Find the Input O₂ Flow (left side of chart).
- 2) Follow the Input O₂ Flow across horizontally to the right to the applicable slanted VE (minute volume) line.
- 3) Read down to the FIO₂ (bottom of chart).

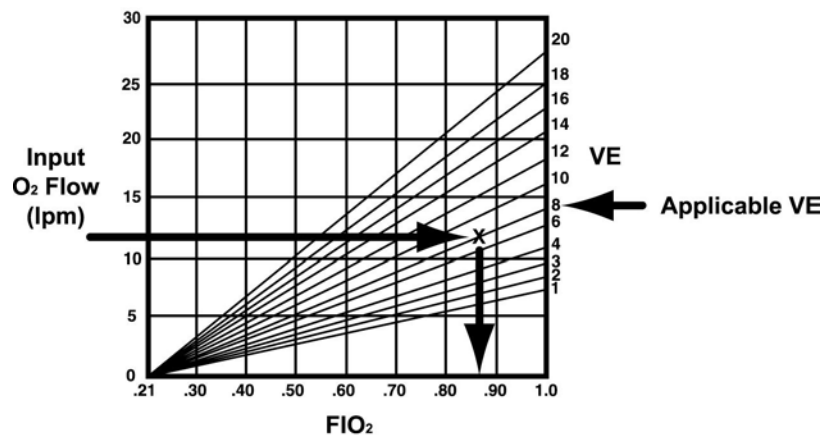

Example - To determine the delivered O₂ concentration

Manual Breath

Use the Manual Breath button to deliver one (1) Machine breath. The breath will be a Volume Control or Pressure Control breath as defined by the current ventilator settings. The Manual Breath LED is on during the Manual Breath inspiration.

To deliver a Manual breath:

- 1) Push the **Manual Breath** button.

The **Manual Breath** button is only active during exhalation.

O₂ % (O₂ Flush) (LTV® 1000 Only)

The O₂ % (O₂ Flush) button is a dual function control (O₂ % and O₂ Flush).

- When being used to set the percentage of oxygen delivered by the ventilator through the oxygen blending system (O₂%), push and release the O₂ % (O₂ Flush) button, as described below.
- When being used to elevate the delivered FIO₂ to 100% for a preset period of time (O₂ Flush), push and hold the O₂ % (O₂ Flush) button for 3 seconds, as described in *Chapter 10 - Extended Features, O₂ Flush*.

The **O₂% control** establishes the percentage of oxygen to be delivered through the oxygen blending system. Oxygen blending requires a high pressure oxygen source and is active only when Low Pressure O₂ Source is not selected²⁰. When Low Pressure O₂ Source is selected, this control is displayed as dashes “---” and may not be modified.

To set the percentage of oxygen delivered by the ventilator:

- 1) Push and release the O₂ % (O₂ Flush) button.
- 2) Change the setting using the Set Value knob.

Range: 21 - 100 %

WARNING

Inspired Oxygen (FIO₂) Concentration – If the patient has a variable respiratory rate, his/her minute ventilation will fluctuate. If exact concentrations of inspired oxygen (FIO₂) are required to be delivered to the patient, it is recommended that an accurate oxygen analyzer with alarms be used.

AVERTISSEMENT

Concentration d'oxygène inspiré (FIO₂) – Si la fréquence respiratoire du patient est variable, sa ventilation-minute va fluctuer. Lorsqu'une concentration exacte d'oxygène inspiré (FIO₂) est nécessaire pour une transmission au patient, il est recommandé d'utiliser un analyseur de niveau d'oxygène² précis, comportant des alarmes.

CAUTION

Oxygen Supply Contamination - The accuracy of the oxygen delivery capabilities of LTV® ventilators can be compromised by foreign debris contamination in the oxygen supply system. To reduce the risk of airborne contaminants entering the ventilator, ensure that any oxygen supply connected to the ventilator is clean, properly filtered²¹ and that the ventilator's O₂ Inlet Port Cap is securely installed on the O₂ Inlet Port whenever the ventilator is not connected to an external oxygen supply.

²⁰ For information on using a low pressure, low flow source, see *Low pressure O₂ source* in this section.

²¹ In addition to the existing internal O₂ Inlet filter, P/N 14313, an External, In-Line Oxygen Filter (P/N 14470) is available from Pulmonetic Systems, Inc.

ATTENTION

Contamination de la réserve d'oxygène — La précision de la capacité d'alimentation en oxygène des ventilateurs LTV[®] peut être compromise par la présence de corps étrangers dans le système d'alimentation en oxygène. Afin de diminuer le risque de présence d'agents contaminants atmosphériques dans le ventilateur, assurez-vous que la réserve d'oxygène reliée au ventilateur est propre et filtrée de manière adéquate²¹, et que le bouchon de l'orifice d'alimentation en oxygène est correctement installé à chaque fois que le ventilateur n'est pas relié à une source d'oxygène externe.

NOTE

The Oxygen Inlet High Pressure Alarm at 85 PSIG and Oxygen Inlet Low Pressure Alarm at 35 PSIG are only active when Low Pressure O₂ Source is off and the O₂ % (O₂ Flush) setting is greater than 21%.

REMARQUE

L'alarme de haute pression d'entrée de l'oxygène réglée sur 85 PSIG, et l'alarme de basse pression d'entrée de l'oxygène réglée sur 35 PSIG ne seront actives que lorsque la source de basse pression O₂ est désactivée et que le réglage du O₂ % (O₂ Flush) est supérieur à 21%.

When the Oxygen Blending option is not installed:

O₂ % (O₂ Flush) is only available when the oxygen blending option is installed. Oxygen may still be supplied through the low pressure low flow inlet²², but the Low Pressure O₂ Source and O₂ % (O₂ Flush) controls, and the Oxygen Inlet Pressure alarms are inactive.

WARNING

Disabled Oxygen Inlet Pressure Alarms - When the oxygen blending option is not installed, the Oxygen Inlet Pressure Alarms are disabled.

AVERTISSEMENT

Alarmes de pression d'entrée de l'oxygène désactivées - Lorsque l'option de mélange d'oxygène n'est pas activée, les alarmes de pression d'entrée de l'oxygène sont désactivées.

²² See *Low Pressure O₂ Source* in this chapter for more information.

On / Standby

This button switches the LTV® Series ventilator between Standby and On.

When the ventilator is on, the **On / Standby** LED will be on. The ventilator will operate on external power if it is available, or internal battery, if there is no external power or the external power source is depleted. The internal battery will be charged from the external power source while the ventilator is operating on external power.

When the ventilator is in Standby, the **On / Standby** LED will be off, however, the internal battery will continue to charge.

To turn the ventilator on from the Standby state:

- 1) Push the On / Standby button.

To put the ventilator into Standby:

- 1) Push and hold the On / Standby button for 3 seconds.
- 2) An **Inop** alarm will occur. To cancel the Inop alarm, push the **Silence/Reset** button.
 - For ventilators with an audio sound symbol (🎵) on the back panel label, verify a confirming audible chirp occurs after the alarm is silenced.
- 3) The **VENT INOP** LED will remain lit for a minimum of 5 minutes.

PEEP Valve

The PEEP Valve establishes the Positive End Expiratory Pressure. The PEEP Valve is located on the exhalation valve assembly. PEEP should be set according to a physician's direction.

To set the PEEP Valve:

- 1) Use the Select button to display the PEEP monitor in the display window.
- 2) Push and hold the PEEP Valve Lock, then rotate the PEEP valve clockwise to increase the pressure or counter-clockwise to decrease the pressure. (See below)

WARNING

Accuracy of PEEP setting - Variations in the patient's breathing pattern and/or leaks in the patient circuit (including leaks around the tracheostomy tube cuff) can affect PEEP. PSI recommends that the clinician set the PEEP to the prescribed level on a test lung while observing the PEEP value in the LTV display window. The clinician should also periodically monitor the PEEP value in the LTV display window. Using an inaccurate PEEP setting due to a patient leak can result in less than prescribed PEEP or undesirable increases in patient circuit pressure when the patient circuit leak changes.

AVERTISSEMENT

Exactitude du paramètre PEP – Les écarts dans le mode de respiration du patient et/ou les fuites du circuit du patient (y compris les fuites autour du ballonnet pour canule de trachéostomie) peuvent affecter le PEP. Des études et investigations préliminaires recommandent que le clinicien définisse le PEP au niveau prescrit sur un poumon d'essai tout en observant la valeur PEP de l'écran graphique LTV. Le clinicien doit par ailleurs surveiller de façon périodique la valeur PEP de l'écran graphique LTV. L'utilisation d'un paramètre PEP inapproprié en raison d'une fuite de patient peut potentiellement résulter en un paramètre inférieur au paramètre PEP prescrit ou en une augmentation indésirable de la pression du circuit du patient lorsque la fuite du circuit du patient change

WARNING

PEEP Valve Rotation – Attempting to adjust the PEEP valve counterclockwise past zero (0) may damage the PEEP valve assembly or cause circuit leaks.

AVERTISSEMENT

Rotation de la valve de pression expiratoire positive – Si vous essayez d'ajuster la valve de pression expiratoire positive en sens inverse des aiguilles d'une montre passé zéro (0), vous pourriez endommager la valve de pression expiratoire positive ou causer une fuite dans le circuit.

PEEP Valve (cont)

- 3) Using the Airway Pressure display and the monitored PEEP as guides, adjust the PEEP Valve until the desired PEEP pressure is displayed and release the PEEP Valve Lock.

Range: 0 to 20 cmH₂O

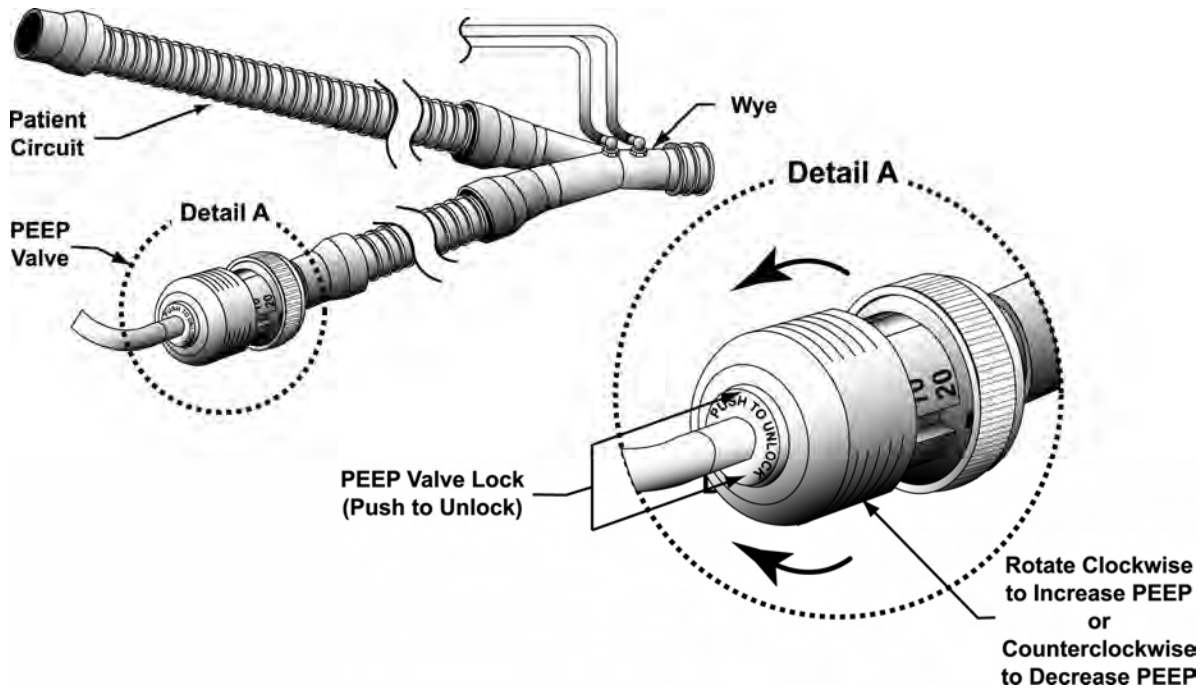

Pressure Control (LTV® 1000 & 950 Only)

This optional control establishes the target pressure above 0 cmH₂O for Pressure Control breaths²³. The inspiratory time for the Pressure Control breath is determined by the Inspiratory Time setting. The ventilator controls inspiratory flow to maintain the set circuit pressure for the set time.

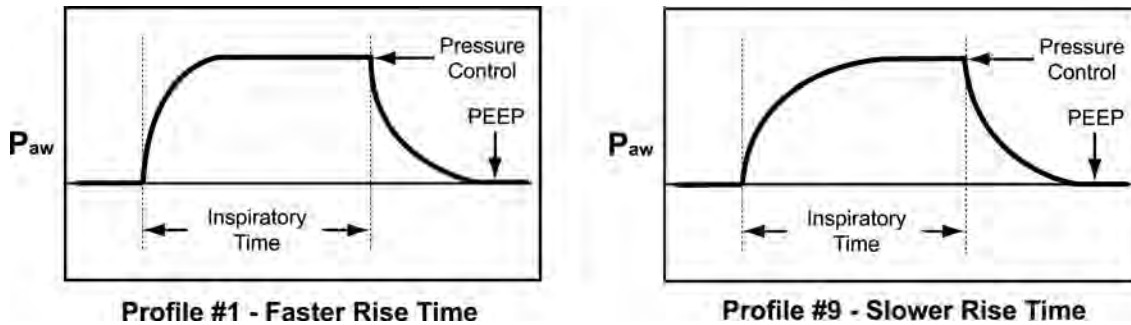

To set the Pressure Control level:

- 1) Push the Pressure Control button.
- 2) Change the setting using the Set Value knob.

To select Pressure Control:

- 1) Toggle the Volume/Pressure mode to select Pressure ventilation²⁴.

Range: 1 - 99 cmH₂O

Flow Termination for Pressure Control breaths may be enabled under Extended Features²⁵. If flow termination is enabled, the Pressure Control display will flash briefly after each flow terminated breath.

The Rise Time profile for Pressure Control breaths may be selected under Extended Features²⁶.

²³ Pressure Control and Pressure Support breaths do not compensate for PEEP. Delivered pressure is controlled by the Pressure Control setting and is not affected by the PEEP setting. i.e.; A Pressure Control setting of 20cmH₂O and a PEEP setting of 10cmH₂O results in a maximum delivered pressure of 20cmH₂O.

²⁴ See *Chapter 6 - Controls* for more information on how to select Pressure ventilation.

²⁵ See *Chapter 10 - Extended Features* for how to set the Variable Flow Termination percentage and enable Flow Termination for Pressure Control breaths.

²⁶ See *Chapter 10 - Extended Features* for how to set the Flow Rise Time profile.

NOTE

Be sure that the Pressure Control setting is higher than the PEEP setting established by the mechanical PEEP valve.

Be sure that Pressure ventilation is selected.

If desired, select optional flow termination and flow termination percentage under Extended Features.

If desired, select the rise time profile under Extended Features. The default setting is Rise Time Profile 4.

REMARQUE

Assurez-vous que le contrôle de la pression est supérieur au réglage PEEP établi par la soupape mécanique PEEP.

Assurez-vous que la pression de ventilation est sélectionnée.

Si souhaité, sélectionnez le débit de terminaison optionnel et le pourcentage de débit de terminaison sous Caractéristiques étendues.

Si souhaité, sélectionnez le profil du temps de montée sous Caractéristiques étendues. Le réglage par défaut est Temps de montée à profil 4.

Pressure Support

This optional control establishes the target pressure above 0 cmH₂O for Pressure Support patient breaths. If Pressure Support is set to dashes “-”, all patient breaths will be given as Spontaneous breaths. Inspiratory flow for Pressure Support and Spontaneous breaths is controlled to meet the patient demand.

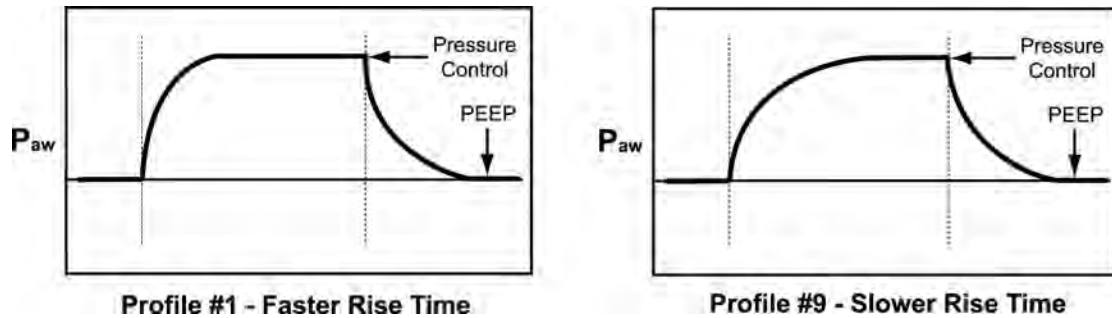

To set Pressure Support:

- 1) Push the Pressure Support button.
- 2) Change the setting using the Set Value knob.

Range: “- -”, 1 - 60 cmH₂O

Pressure Support breaths may be terminated by flow or by time.

Flow Termination: Pressure Support breaths are flow terminated when the flow decreases to a set percentage of the peak flow²⁷ delivered for that breath.

Time Termination: Pressure Support breaths are time terminated²⁸ when the inspiratory time exceeds two breath periods, or when the inspiratory time exceeds the set Time Termination Limit²⁹ before the flow termination criteria is reached. The Pressure Support display will flash briefly after each time terminated breath.

The Rise Time profile for Pressure Support breaths may be selected under Extended Features³⁰.

²⁷ See *Chapter 10 - Extended Features* for how to set the Variable Flow Termination for Pressure Support breaths. Spontaneous breaths are terminated at 10% of peak flow, or when flow drops below 3 Lpm.

²⁸ Only Pressure Support breaths are time terminated. Spontaneous breaths, where Pressure Support is set to “- -”, are not time terminated.

²⁹ See *Chapter 10 - Extended Features* for how to set the Variable Time Termination.

³⁰ See *Chapter 10 - Extended Features* for how to set the Flow Rise Time profile.

NOTE

Be sure that the Pressure Support setting is higher than the PEEP setting established by the mechanical PEEP valve.

If desired, select the flow termination percentage under Extended Features. The default setting is 25%.

If desired, select the rise time profile under Extended Features. The default setting is Rise Time Profile 4.

REMARQUE

Assurez-vous que le réglage du contrôle de la pression est supérieur au réglage PEEP établi par la soupape mécanique PEEP.

Si souhaité, sélectionnez le pourcentage du débit de terminaison optionnel sous Caractéristiques étendues. Le réglage par défaut est 25%.

Si souhaité, sélectionnez le profil du temps de montée sous Caractéristiques étendues. Le réglage par défaut est Temps de montée à profil 4.

Select

Use this button to change the monitor in the display window and to select items in the Extended Feature menus.

Monitored Data:

The monitored data displays may be automatically or manually scrolled.

To cycle through the available monitored data automatically from a halted scan:

- 1) Push the monitor Select button twice within 0.3 sec.
- 2) Pushing the Select button once while scan is active will halt scanning and the currently displayed data will remain in the display window.
- 3) Each time you push the button once, the next data item in the list will be displayed.
- 4) To resume scan, push the Select button twice.

The monitored data is displayed for 3 seconds.

Extended Features:

To enter the Extended Features menu:

- 1) Push and hold the Select button for 3 seconds.

The first Menu Item will be displayed, for example: **ALARM OP**

For more information on how to use the Extended Features menu, see *Chapter 10 - Extended Features*.

Sensitivity

Use the Sensitivity control to establish the threshold level to allow the patient to flow trigger Assist and Patient breaths.

A flow trigger occurs when:

- The sensitivity is set to any value from 1 to 9,
- *And* the ventilator is in exhalation phase,
- *And* the minimum exhalation time has expired,
- *And* the flow is greater than or equal to the Sensitivity setting.

The **LEAK** measurement displayed in the **RT XDCR DATA** menu can be used to help select an appropriate sensitivity value. Typically, the sensitivity value is set higher than the displayed **LEAK** measurement. For instance, if the **LEAK** measurement were up to 2.53, a minimum sensitivity of three (3) would be appropriate.

Backup pressure triggers are enabled when the setting is any value other than a dash "-".

A backup pressure trigger occurs when:

- The sensitivity is set to any value from 1 to 9,
- *And* the ventilator is in exhalation phase,
- *And* the minimum exhalation time has expired,
- *And* the airway pressure drops below -3 cmH₂O.

When a trigger is detected, the Patient Effort LED is illuminated briefly.

NOTE

Triggers are disabled when the Sensitivity setting is set to "-".

REMARQUE

Les amorces sont désactivées lorsque le réglage de la sensibilité est réglé sur « - ».

To set Sensitivity:

- 1) Push the Sensitivity button.
- 2) Change the setting using the Set Value knob.

Range: 1 - 9, "-", 1 is the most sensitive, 9 is the least sensitive and "-" is off.

Set Value Knob

Use the Set Value Knob to establish control values and navigate extended features menus.

Variable Controls:

To change the setting for a variable control:

- 1) Push the button for the control to be modified.
- 2) Turn the Set Value knob clockwise to increase the value, or
- 3) Turn the Set Value knob counter-clockwise to decrease the value.

To change the setting by small increments, turn the knob slowly. To change the setting by larger increments, turn the knob more quickly.

Extended Features:

To navigate through a list of items in an Extended Features menu:

- 1) Turn the Set Value knob clockwise to display the next menu item, or
- 2) Turn the Set Value knob counter-clockwise to display the previous menu item.

Silence / Reset

Use this button to silence an alarm for 60 seconds, to reset an alarm, to start a 60 second preemptive silence period, and to permanently silence the **Vent Inop** and **Standby** alarms. Two important definitions for understanding how the Silence / Reset button works:

- **Active alarm:** An alarm for which the condition currently exists.
- **Inactive alarm:** An alarm that has occurred, but for which the condition no longer exists.

Silencing and Clearing Alarms:

To silence an active alarm for 60 seconds:

- 1) Push the Silence / Reset button. The audible alarm will be silenced for 60 seconds. Once the silence period expires, the audible alarm will resume sounding.

To clear an inactive alarm:

- 1) Push the Silence / Reset button. The visual alarm displays will be cleared.

To cancel an active alarm:

- 1) Push the Silence / Reset button twice. The audible alarm will be silenced and the visual alarm displays will be cleared and the silence period will be terminated.

Preemptive Silence Period

To start a preemptive silence period:

- 1) Push the Silence / Reset button. A 60 second silence period will begin. For any alarms that occur during the silence period, the visual displays will flash, but the audible alarm will remain silenced until the end of the silence period.

Vent Inop and Standby alarms:

To silence the Vent Inop or Standby alarm:

- 1) Push the Silence / Reset button. The audible alarm will be permanently silenced, but the **Vent Inop** LED will remain lit for a minimum of 5 minutes. This does not adversely affect battery life.

Tidal Volume

Use the Tidal Volume Control to establish the volume of gas which the ventilator will produce and deliver during Volume Controlled breaths. Flow is delivered in a taper waveform over the set Inspiratory Time. The peak flow is calculated based on the Tidal Volume and Inspiratory Time with a maximum flow of 100 lpm and a minimum flow of 10 lpm. Flow is decelerated from the calculated peak flow to 50% of the calculated peak flow.

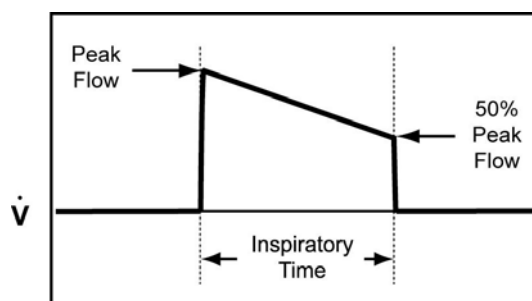

Taper Waveform

While the Tidal Volume is being updated, the Calculated Peak Flow is displayed in the display window.

To set the Tidal Volume:

- 1) Push the Tidal Volume button.
- 2) Change the setting using the Set Value knob.
- 3) Push the Tidal Volume button again to deselect the setting and accept the new value.

Range: 50 - 2000 ml

NOTE

Be sure that **Volume** ventilation is selected.

REMARQUE

Assurez-vous que le **volume** de ventilation est sélectionné.

Volume / Pressure Mode (LTV® 1000 & 950 Only)

Use this button to toggle between **Pressure Control** and **Volume Control** modes of ventilation.

To toggle between the modes:

- 1) Push the mode button once. The associated LED will flash for 5 seconds.
 - 2) To confirm the mode change, push the mode button again while the LED is flashing.
- The ventilator will begin operating in the new mode as soon as the mode change is complete.

Chapter 7 - DISPLAYS AND INDICATORS

This section describes each of the LTV® Series ventilator front panel displays.

Airway Pressure

The Airway Pressure display is a bar of 60 LEDs that is used to display the real-time airway circuit pressure. The displayed pressures range from -10 cmH₂O to 108 cmH₂O in increments of 2 cmH₂O. In addition to displaying the real-time airway pressure, a single LED is lit showing the Peak Inspiratory Pressure of the previous breath.

Display Window

The display window is a 12 character, 5x7 dot matrix array that is used to display alarms, monitored data, and Extended Features menu items. Messages are displayed with the following priorities (highest to lowest):

- Alarm Messages³¹
- Extended Features Menu Items³²
- Monitored Data³³

Indicators

The following section describes the purpose of the LED indicators on the front panel that do not have associated front panel controls.

³¹ See *Chapter 9 - Ventilator Alarms* and *Chapter 6 - Controls, Silence / Reset* for more information on how to clear alarm displays.

³² See *Chapter 10 - Extended Features* for more information on how to use the Extended Features Menus.

³³ See *Chapter 8 - Monitored Data* and *Chapter 6 - Controls, Select* for more information on displaying monitors.

Battery Level

The Battery Level indicator shows the level of available internal battery power while running from the internal battery. When the ventilator is running from an external power source, the Battery Level indicator is off. When running from the internal battery at the nominal settings shown below, the indicator shows the following levels:

Alarm	LED Color	Battery Level	Approximate Battery Time (Total time: 60 mins)
--	Green	Internal battery level is acceptable	45 minutes
BAT LOW	Amber	Internal battery level is low	10 minutes
BAT EMPTY	Red	Internal battery level is critically low	5 minutes

Nominal Settings

Mode	Assist/Control, Volume	Peep	5 cmH ₂ O
Breath Rate	15 bpm	O ₂ %	21%
Tidal Volume	800 ml	Lung Compliance	50 ml/cmH ₂ O
Inspiratory Time	1.5 sec	ET Tube Resistance	5.87 cmH ₂ O/L/s
Sensitivity	2 lpm	Battery Temperature	25° C

When an LTV[®] Series ventilator is operated on its internal battery to the point that the internal battery is completely depleted, the ventilator will shut down. If the ventilator remains in this state, the internal battery may recharge slightly within a few seconds / minutes and cause the ventilator to automatically restart and operate for a short period of time. This cycle may repeat several times, depending on the condition of the internal battery.

 **WARNING**

Battery run time - When the battery reaches the **BAT LOW** level, the ventilator will only run for approximately 10 minutes before generating a battery empty alarm (**BAT EMPTY**). The approximate times shown here are based on tests using the **nominal settings, a new battery and a full 8- hour charge cycle** as specified in *Appendix A - Ventilator Specifications*. Actual run time may be more or less depending on ventilator settings, patient demand, and battery age or condition. It is highly recommended that an alternate power source is secured **PRIOR** to the ventilator reaching the **BAT EMPTY** alarm condition to ensure continuous, uninterrupted patient ventilation.

 **AVERTISSEMENT**

Durée d'utilisation de la batterie – Lorsque la batterie atteint le niveau **BAT INT BASS**, le ventilateur fonctionne pendant environ 10 minutes avant d'émettre une alarme de batterie faible (**BAT INT VIDE**). Cette durée approximative est basée sur des tests avec des paramètres nominaux, une nouvelle batterie et un cycle de chargement complet de 8 heures, tel que spécifié dans l'*Annexe A – Spécifications du ventilateur*. La durée d'utilisation réelle pourrait être supérieure ou inférieure, selon les paramètres du ventilateur, la demande du patient et l'âge ou l'état de la batterie. Il est fortement recommandé qu'une source d'alimentation alternative soit connectée **AVANT** que le ventilateur n'atteigne l'état d'alarme **BAT INT VIDE** afin d'assurer une ventilation continue et ininterrompue au patient.

Charge Status

The **Charge Status** indicator shows the charge state of the internal battery. This LED is on when the ventilator is supplied with external power and the internal battery is being charged. The charge status is indicated as follows:

LED Color	Charge Status
Flashing Amber	The ventilator is performing pre-charge testing of the battery before starting the charge process. This occurs when external power is first connected. The process normally takes a few seconds but may take up to an hour on a deeply discharged battery.
Green	The internal battery is charged to full level. While in this state, the charger will continue to trickle charge the battery.
Amber	The internal battery is being bulk charged. The battery has not reached a full charge level yet.
Red	The ventilator has detected a charge internal battery fault. The internal battery cannot be charged.

CAUTION

Charge Fault - If the Charge Status LED indicates a charge fault, contact a certified Pulmonetic Systems' service technician immediately.

Internal Battery Use: The internal battery is intended for use during short periods while switching between external power supplies, in emergencies or for short duration transports. The length of time the ventilator will operate on internal power is a function of factors such as settings, charge level and condition of the battery; therefore, the use of the internal battery as a standard operating practice is not recommended.

ATTENTION

Erreur de charge - Si le DEL de l'état de charge indique une erreur de charge, veuillez contacter immédiatement un technicien de service certifié Pulmonetic Systems.

Utilisation de la batterie interne: La batterie interne est conçue pour être utilisée sur de courtes périodes pendant la commutation entre des connexions d'alimentation externe, les situations d'urgence ou les transports de courte durée. La durée pendant laquelle le ventilateur fonctionnera sur l'alimentation interne dépend de facteurs tels, la configuration, le niveau de la charge et la condition de la batterie; l'utilisation de la batterie interne pour l'opération normale n'est donc pas recommandée.

External Power

The **External Power** indicator shows the level of external power while the ventilator is operating from an external power source. When the ventilator is running from the internal battery, the **External Power** indicator is off. When running from external power, the indicator shows the following levels: (See *Chapter 7 - Battery Level* for approximate battery time.)

LED Color	Power Level
Green	External Power level is acceptable
Amber	External Power level is low

External power may be provided by connecting the ventilator to an external DC power source, external battery or to the LTV® AC Power Adapter.

CAUTION

AC Power Source - When connecting the ventilator to an AC power source, use only the approved LTV® AC Power Adapter.

External DC Power Source or External Battery - When connecting the LTV® Series ventilator to an external DC power source or external battery, use only the approved method and connectors specified in *Chapter 14 - Power and Battery Operation*.

Internal Battery Use: The internal battery is intended for use during short periods while switching between external power supply connections, emergency situations or short duration transports. The length of time the ventilator will operate on internal power is a function of many factors such as settings, charge level and condition or age of the battery; therefore, the use of the internal battery as a standard operating practice is not recommended.

ATTENTION

Source d'alimentation c.a. - Lorsque vous branchez le ventilateur sur une source d'alimentation c.a., utilisez l'adaptateur c.a. LTV® approuvé.

Source de courant continu ou pile externe - Lorsque vous branchez les ventilateurs de la série LTV® sur une source de courant continu ou sur une pile externe, utilisez seulement les méthodes et les connecteurs approuvés spécifiés au chapitre 14 - Alimentation et opération avec pile.

Utilisation de la batterie interne: La batterie interne est conçue pour être utilisée sur de courtes périodes pendant la commutation entre des connexions d'alimentation externe, les situations d'urgence ou les transports de courte durée. La durée pendant laquelle le ventilateur fonctionnera sur l'alimentation interne dépend de plusieurs facteurs tels, la configuration, le niveau de la charge et la condition ou l'âge de la batterie; l'utilisation de la batterie interne pour l'opération normale n'est donc pas recommandée.

NPPV

The NPPV³⁴ indicator LED is lit when NPPV mode is selected. NPPV mode is selected under the Extended Features. For more information on NPPV mode, see *Chapter 4 - Ventilation Modes*, NPPV and *Chapter 10 - Extended Features*.

Patient Effort

This LED is lit briefly each time a patient trigger is detected. See *Chapter 6 - Controls, Sensitivity* for more information on patient triggers.

Vent Inop

The **Vent Inop** LED is lit any time the ventilator is in the Inop state. This occurs when:

- The ventilator is put into Standby using the On / Standby button.
- The ventilator power sources, both external and internal, are insufficient to operate the ventilator.
- A **Vent Inop** alarm sounds.

An audible alarm sounds continuously when the ventilator enters the Vent Inop state, and may be silenced by pushing the Silence / Reset button.

While in the Vent Inop state, the ventilator is set to a safe state, allowing the patient to breathe spontaneously from room air.

³⁴ Non-Invasive Positive Pressure Ventilation

Chapter 8 - MONITORED DATA

This section describes each of the monitored data displays and how the data is calculated. Monitored data is shown in the Display Window and is actively updated whenever alarms and extended features are not displayed.

NOTE

Some monitored data depends on valid transducer calibrations. If valid calibration data is not available, the monitored data display will be replaced with the message **NO CAL**.

REMARQUE

Certaines données surveillées dépendent de la validité du calibrage du transducteur. Si des données de calibrage valides ne sont pas disponibles, les données surveillées affichées seront remplacées par le message **NO CAL**.



WARNING

NO CAL Condition - Operation of the LTV® Series ventilator under a **NO CAL** condition may result in inaccurate pressure and volume measurements. Should this condition occur, disconnect the patient from the ventilator, provide an alternative method of ventilation and immediately contact a certified Pulmonetic Systems' service technician or Pulmonetic Systems, Inc.



AVERTISSEMENT

Condition NO CAL - L'opération continue du ventilateur de la série LTV® sous condition **NO CAL** peut résulter en mesures de pression et de volume erronées. Si cette condition se présente, le ventilateur doit être retiré du service, et vous devez immédiatement contacter votre technicien de service certifié de Pulmonetic Systems ou Pulmonetic Systems Inc.

Automatic or Manual Data Display Scrolling

The monitored data displays may be automatically or manually scrolled.

To cycle through the available monitored data automatically from a halted scan:

- 1) Push the monitor Select button twice within 0.3 seconds.
- 2) Pushing the Select button once while scan is active will halt scanning and the currently displayed data will remain in the display window.
- 3) Each time you push the button once, the next data item in the list will be displayed.
- 4) To resume scan, push the Select button twice.

The monitored data is displayed for 3 seconds, in the following order:

Display	Monitored Data	Units
PIP	Peak Inspiratory Pressure	cmH ₂ O
MAP	Mean Airway Pressure	cmH ₂ O
PEEP	Positive End Expiratory Pressure	cmH ₂ O
f	Total Breath Rate	Breaths Per Minute
Vte	Exhaled Tidal Volume	Milliliters
VE	Minute Volume	Liters
I:E	I:E Ratio	Smaller unit normalized to 1
I:Ecalc	Calculated I:E ratio based on Breath Rate and Inspiratory Time	Smaller unit normalized to 1
Vcalc	Calculated Peak Flow for Volume Breaths	Liters Per Minute

Following the displayed monitored data, the Alarm Informational Messages listed below (when applicable) will be displayed for 3 seconds.

NOTE

While automatic scrolling is active and when applicable, the following messages³⁵ will also be displayed along with the monitored data:

- * LMV OFF
- * LPPS OFF
- * LMV LPPS OFF
- * HIGH f OFF
- * HI PEEP OFF
- * f PEEP OFF

REMARQUE

Lorsque le défilement automatique est actif, et en fonction du contexte, les messages suivants seront également affichés avec les données surveillées :

- * Vmin ARRET
- * PminAI ARRET
- * Vm-Pmin NON
- * f HTE ARRET
- * PEPmax ARRET
- * f PEP ARRET

³⁵ See Chapter 9 - Ventilator Alarms, Alarm Status Messages for additional information.

PIP xxx cmH₂O

The Peak Inspiratory Pressure (PIP) monitor displays the greatest pressure measured during the inspiratory phase and the first 300 ms of exhalation³⁶.

Monitored PIP data is measured and displayed at the completion of inspiration.

MAP xx cmH₂O

The Mean Airway Pressure (MAP) monitor displays a running average of the airway pressure for the last 60 seconds. MAP data is recalculated and displayed in 10 second intervals.

PEEP xx cmH₂O

The Positive End Expiratory Pressure (PEEP) monitor displays the pressure in the patient circuit at the completion of exhalation. PEEP data is displayed at the completion of exhalation.

WARNING

Accuracy of PEEP setting - Variations in the patient's breathing pattern and/or leaks in the patient circuit (including leaks around the tracheostomy tube cuff) can affect PEEP. PSI recommends that the clinician set the PEEP to the prescribed level on a test lung while observing the PEEP value in the LTV display window. The clinician should also periodically monitor the PEEP value in the LTV display window. Using an inaccurate PEEP setting due to a patient leak can result in less than prescribed PEEP or undesirable increases in patient circuit pressure when the patient circuit leak changes.

AVERTISSEMENT

Exactitude du paramètre PEP – Les écarts dans le mode de respiration du patient et/ou les fuites du circuit du patient (y compris les fuites autour du ballonnet pour canule de trachéostomie) peuvent affecter le PEP. Des études et investigations préliminaires recommandent que le clinicien définisse le PEP au niveau prescrit sur un poumon d'essai tout en observant la valeur PEP de l'écran graphique LTV. Le clinicien doit par ailleurs surveiller de façon périodique la valeur PEP de l'écran graphique LTV. L'utilisation d'un paramètre PEP inapproprié en raison d'une fuite de patient peut potentiellement résulter en un paramètre inférieur au paramètre PEP prescrit ou en une augmentation indésirable de la pression du circuit du patient lorsque la fuite du circuit du patient change

f xxx bpm

The Total Breath Rate displays the breaths per minute based on the last 8 breaths, and includes all breath types. Total Breath Rate is recalculated and updated at the end of each exhalation or every 20 seconds.

³⁶ This is done to protect the patient, since often the highest pressure is obtained at the beginning of the exhalation phase.

Vte xxx ml

The Exhaled Tidal Volume (Vte) monitor displays the tidal volume as measured at the patient wye. Vte data is recalculated and displayed at the completion of every exhalation.

VE xx.x L

The Minute Volume (VE) monitor displays the exhaled tidal volume for the last 60 seconds as calculated from the last 8 breaths. VE data is recalculated and displayed at the completion of every exhalation or every 20 seconds, whichever occurs first.

I:E xx:xx

The I:E Ratio displays the unitless ratio between measured inspiratory time and measured exhalation time. The smaller of the inspiratory and exhalation times is normalized to one. Both normal and inverse I:E Ratios are displayed.

NOTE

In normal ventilation, I:Ecalc (calculated I:E ratio) is displayed while changes are being made to the Inspiratory Time or the Breath rate values.

REMARQUE

En mode de ventilation normale, IEcalc (ratio I:E calculé) est affiché pendant que des changements sont apportés aux valeurs Durée inspiratoire ou Rythme respiratoire.

I:Ecalc xx:xx

The Calculated I:E ratio (I:Ecalc) display is based on the set Breath Rate and Inspiratory Time. The display is updated in real-time while either setting is being changed. In modes where Vcalc is displayed during Inspiratory Time changes, the display can be toggled between **Vcalc** and **I:E calc** using the **Select** button.

Vcalc xxx Lpm

The Calculated Peak Flow is based on the Tidal Volume and Inspiratory Time settings. Vcalc is included in the list of monitored values when Volume ventilation is selected, and is not included when pressure ventilation is selected. Vcalc is automatically displayed when Tidal Volume or Inspiratory Time³⁷ is selected for change. When both controls are deselected, the previously displayed monitored data will be restored to the display window.

³⁷ Vcalc is only displayed while Inspiratory Time is selected if Volume Mode is selected. Vcalc is displayed any time Tidal Volume is selected regardless of the current ventilation mode.

Chapter 9 - VENTILATOR ALARMS

When conditions requiring immediate operator interaction are detected by the LTV[®] Series ventilator, an alarm is generated. Some alarms can reset themselves, for instance, a high pressure alarm that is caused by a cough. Other alarms require some action from the operator and the audible and visual alarms will continue until the problem is corrected.

When an alarm occurs:

- A flashing alarm message appears in the display window.
- An audible alarm sounds.
- Any associated control displays flash.
- Depending on the alarm, other actions may be taken, such as terminating an inspiration or opening the exhalation valve.

When an alarm condition clears:

- The audible alarm is silenced.
- The alarm message continues to flash in the display window.
- Any associated control displays continue to flash.



WARNING

Adjustable and Critical Alarms – For safety purposes, all adjustable alarms and all critical alarms must be checked to insure proper operation.

Audible Alarms - Failure to immediately identify and correct audible alarm situations may result in serious patient injury.



AVERTISSEMENT

Alarmes ajustables et critiques - Afin d'assurer l'opération sécuritaire des ventilateurs de la série LTV[®], toutes les alarmes ajustables doivent être réglées avant l'opération. De plus, toutes les alarmes critiques (par exemple, alarme de basse pression), doivent être inspectées avant de laisser le patient seul.

Alarmes sonores - L'échec à identifier et à corriger dans l'immédiat les situations d'alarmes sonores peut causer des blessures au patient.

The following sections describe what alarms can occur on the LTV[®] Series ventilator and how to correct them.

APNEA, APNEA xx bpm

When the time since the start of the last breath is longer than the set Apnea Interval, the **APNEA** alarm is generated. When an Apnea alarm occurs, the ventilator will enter Apnea Backup ventilation mode. For more information on Apnea Backup mode, see *Chapter 4 - Ventilation Modes, Apnea Backup*. For more information on the variable Apnea Interval, see *Chapter 10 - Extended Features*.

When an APNEA alarm occurs:

- Any inspiration in progress is terminated.
- The ventilator changes to Apnea Backup ventilation.
- The **APNEA xx bpm** backup ventilation breath rate is displayed.
- Control displays used while in Apnea Backup mode are illuminated and all other control displays are dimmed.
- The audible alarm is sounded.

While in Apnea Backup mode, the alarm will continue to sound and the alarm message and breath rate will be flashed in the display window. Apnea backup mode will continue until the operator resets the alarm or the patient triggers 2 consecutive breaths.

When the APNEA alarm is reset by 2 consecutive triggered breaths:

- Apnea Backup Ventilation terminates and the ventilator returns to the previous mode.
- The **APNEA** alarm message remains flashing in the window but the breath rate is no longer displayed.
- Control displays used in the selected ventilation mode are illuminated and all other control displays are dimmed.
- The audible alarm is silenced.

To reset the APNEA alarm and exit Apnea Backup ventilation:

- 1) Push the Silence / Reset button twice.

BAT EMPTY

When the ventilator is operating on internal battery power and the battery charge level falls below the empty threshold, the **BAT EMPTY** alarm is generated. For patient safety, this alarm can only be silenced once for 30 seconds and cannot be silenced preemptively. After the 30 seconds has elapsed, the alarm cannot be silenced again and will continue to sound and display until an alternate power source is provided or the battery is depleted and the ventilator goes INOP. This alarm will always sound at maximum volume (85 dbA)

WARNING

BAT EMPTY alarm - A **BAT EMPTY** alarm indicates the internal battery is almost depleted. Connect the ventilator to an external power source immediately.

AVERTISSEMENT

Alarme BAT EMPTY - Une alarme **BAT EMPTY** indique que la pile interne est pratiquement à plat. Branchez immédiatement le ventilateur à une source d'alimentation externe.

When a BAT EMPTY alarm occurs:

- The **Battery Level** LED displays red.
- The **BAT EMPTY** message is displayed.
- The audible alarm is sounded.

NOTE

Volume of the **BAT EMPTY** alarm cannot be lowered. For patient safety, this alarm will always sound at full volume

REMARQUE

Le volume de l'alarme batterie faible ne peut être réduit. Pour la sécurité des patients, le volume de l'émission de cette alarme est toujours fort.

To temporarily silence the BAT EMPTY alarm:

- 1) Push the Silence / Reset button once to silence the audible alarm for 30 seconds only.

The **BAT EMPTY** alarm can only be silenced once and cannot be reset until the battery is recharged or external power is applied.

NOTE

When the battery reaches empty, the ventilator may run for approximately 5 minutes before shutdown, based on the nominal settings, a new battery and a full 8 - hour charge cycle as specified in *Appendix A - Ventilator Specifications*. Actual run time may be more or less depending on ventilator settings, patient demand, and battery age.

Internal Battery Use: The internal battery is intended for use during short periods while switching between external power supply connections, emergency situations or short duration transports. The length of time the ventilator will operate on internal power is a function of many factors such as settings, charge level and condition or age of the battery; therefore, the use of the internal battery as a standard operating practice is not recommended.

REMARQUE

Lorsque la batterie atteint le niveau Vide, le ventilateur continuera de fonctionner pendant environ cinq minutes avant de s'éteindre, dans le cas de réglages nominaux, d'une nouvelle batterie et d'un cycle de charge complet de huit heures, tel que spécifié dans *l'annexe A, Ventilator Specifications*. La durée de fonctionnement réelle peut être inférieure ou supérieure, suivant les réglages du ventilateur, les besoins du patient et l'âge de la batterie.

Utilisation de la batterie interne: La batterie interne est conçue pour être utilisée sur de courtes périodes pendant la commutation entre des connexions d'alimentation externe, les situations d'urgence ou les transports de courte durée. La durée pendant laquelle le ventilateur fonctionnera sur l'alimentation interne dépend de plusieurs facteurs tels, la configuration, le niveau de la charge et la condition ou l'âge de la batterie; l'utilisation de la batterie interne pour l'opération normale n'est donc pas recommandée.

When an LTV® Series ventilator is operated on its internal battery to the point that the internal battery is completely depleted, the ventilator will shut down. If the ventilator remains in this state, the internal battery may recharge slightly within a few seconds / minutes and cause the ventilator to automatically restart and operate for a short period of time. This cycle may repeat several times, depending on the condition of the internal battery.

BAT LOW

When the ventilator is operating on internal battery power and the battery charge level falls below the low threshold, a **BAT LOW** alarm is generated.

When a **BAT LOW** alarm occurs:

- The **Battery Level** LED is displayed Amber.
- The **BAT LOW** message is displayed.
- The audible alarm is sounded.

To reset the **BAT LOW** alarm:

- 1) Push the Silence / Reset button twice.

WARNING

Battery run time: When the battery reaches the **BAT LOW** level, the ventilator will only run for approximately 10 minutes before generating a battery empty alarm (**BAT EMPTY**). This approximate time is based on tests using the **nominal settings, a new battery and a full 8 hour charge cycle** as specified in *Appendix A - Ventilator Specifications*. Actual run time may be more or less depending on ventilator settings, patient demand, and battery age or condition. It is highly recommended that an alternate power source is connected **PRIOR** to the ventilator reaching the **BAT EMPTY** alarm condition to ensure continuous, uninterrupted patient ventilation

AVERTISSEMENT

Durée d'utilisation de la batterie – Lorsque la batterie atteint le niveau **BAT INT BASS**, le ventilateur fonctionne pendant environ 10 minutes avant d'émettre une alarme de batterie faible (**BAT INT VIDE**). Cette durée approximative est basée sur des tests avec des paramètres nominaux, une nouvelle batterie et un cycle de chargement complet de 8 heures, tel que spécifié dans l'*Annexe A – Spécifications du ventilateur*. La durée d'utilisation réelle pourrait être supérieure ou inférieure, selon les paramètres du ventilateur, la demande du patient et l'âge ou l'état de la batterie. Il est fortement recommandé qu'une source d'alimentation alternative soit connectée **AVANT** que le ventilateur n'atteigne l'état d'alarme **BAT INT VIDE** afin d'assurer une ventilation continue et ininterrompue au patient

NOTE

Internal Battery Use: The internal battery is intended for use during short periods while switching between external power supply connections, emergency situations or short duration transports. The length of time the ventilator will operate on internal power is a function of factors such as settings, charge level and condition or age of the battery; therefore, the use of the internal battery as a standard operating practice is not recommended.

REMARQUE

Utilisation de la batterie interne: La batterie interne est conçue pour être utilisée sur de courtes périodes pendant la commutation entre des connexions d'alimentation externe, les situations d'urgence ou les transports de courte durée. La durée pendant laquelle le ventilateur fonctionnera sur l'alimentation interne dépend de plusieurs facteurs tels, la configuration, le niveau de la charge et la condition ou l'âge de la batterie; l'utilisation de la batterie interne pour l'opération normale n'est donc pas recommandée.

When an LTV® Series ventilator is operated on its internal battery to the point that the internal battery is completely depleted, the ventilator will shut down. If the ventilator remains in this state, the internal battery may recharge slightly within a few seconds / minutes and cause the ventilator to automatically restart and operate for a short period of time. This cycle may repeat several times, depending on the condition of the internal battery.

DEFAULTS

All controls and extended features on the LTV[®] Series ventilator have factory-set default values. When the operator makes changes to the controls or extended features settings, the ventilator stores the new settings in non-volatile memory³⁸. During POST, the ventilator checks the stored settings. If the ventilator detects an invalid stored setting, the **DEFAULTS** alarm occurs and the affected settings are set to the default values.

When a DEFAULTS alarm is generated:

- An audible alarm is sounded.
- The **DEFAULTS** message is flashed in the display window.
- All affected controls or features are set to their default values.

To reset the DEFAULTS alarm:

- 1) Push the Silence / Reset button twice.
- 2) Select and return the control(s) or features to the desired settings.

NOTE

Be sure to check all Controls, Alarms and Extended Features options and return them to the desired settings.

Repeated occurrences of the **DEFAULTS** alarm may indicate a problem with the ventilator's non-volatile memory. Please immediately contact a certified Pulmonetic Systems' service technician.

Control values are re-set to default values each time the ventilator is turned on, **only** if an invalid stored setting is detected during POST.

REMARQUE

Assurez-vous de procéder à la vérification de toutes les options de contrôles, d'alarmes et de caractéristiques étendues, et de les retourner aux réglages souhaités.

L'occurrence répétitive des alarmes **PAR DÉFAUT** peut indiquer un problème avec la mémoire non volatile du ventilateur. Veuillez contacter immédiatement un technicien de service certifié de Pulmonetic Systems.

Les valeurs de contrôle sont rétablies à leurs valeurs par défaut chaque fois que le ventilateur est allumé, **seulement** si un paramètre en mémoire non valable est détecté au moment du diagnostic automatique de mise sous tension.

³⁸ Non-volatile memory is memory that is not erased when the ventilator is turned off or disconnected.

DEFAULTS (cont.)

The factory-set default Control settings are:

- Some Controls are not applicable to all LTV[®] ventilators; see *Chapter 6 - Controls*, for detailed information concerning specific Controls.

<u>Control</u> - <u>Default</u>	<u>Control</u> - <u>Default</u>
Breath Rate - 12 bpm	Low Pressure O ₂ Source - Off
Control Lock - On	Pressure Control - 1 cmH ₂ O
Data Display Scrolling - Auto-On	Pressure Support - 1 cmH ₂ O
High Pressure Limit - 20 cmH ₂ O	Sensitivity - 2 Lpm
Inspiratory/Expiratory Hold - Off	Tidal Volume - 500 ml
Inspiratory Time - 1.5 sec	Ventilation Mode - Assist / Control
Low Minute Volume - 2.5 Lpm	Volume / Pressure Mode - Volume
Low Pressure - 5 cmH ₂ O	O ₂ % (O ₂ Flush) - 21%

The factory-set default Extended Features settings are:

- Some Extended Features are not applicable to all LTV[®] ventilators; see *Chapter 10 - Extended Features*, for detailed information concerning specific Features.

<u>Feature</u> - <u>Default</u>	<u>Feature</u> - <u>Default</u>
O ₂ Flush Period - 3 min	Leak Compensation - On
Alarm Volume - 85 dBA	LPP Alarm - All Breaths
Apnea Interval - 20 sec	NPPV Mode - Off
Com Setting ³⁹ - Data	O ₂ Duration Cylinder Press - 2000 psi or 138 bar
Control Unlock - Easy	O ₂ Duration Cylinder Size - 622 liters
Date Format ³⁹ - mm/dd/yyyy	PC Flow Termination - Off
High f Alarm - High f Off	PIP LED - On
High f Alarm Delay - 30 sec	PNT Assist - Normal
High PEEP Alarm - High PEEP Off	Rise Time Profile - 4
HP Alarm Delay - No Delay	Variable Flow Termination - 25%
Language ³⁹ - English	Variable Time Termination - 1.5 sec

³⁹ This feature is not reset to default values when the **SET DEFAULTS** option is used in Extended Features.

DEFAULTS SET

The **DEFAULTS SET** alarm is generated when the LTV® Ventilator is first powered up after the **SET DEFAULTS**⁴⁰ option has been used to reset all controls and extended features settings to their factory-set default values⁴¹.

- Language, Time/Date Format and Com settings are not reset to default values when the SET DEFAULTS option is used in Extended Features.

When a DEFAULTS SET alarm is generated:

- The **DEFAULTS SET** message is flashed in the display window.
- The audible alarm is sounded.

To reset the DEFAULTS SET alarm:

- 1) Push the Silence / Reset button twice.
- 2) Select and return the control(s) and extended features settings to the desired settings.

NOTE

Be sure to check all Controls, Alarms and Extended Features options and return them to the desired settings.

REMARQUE

Assurez-vous de procéder à la vérification de toutes les options de contrôles, d'alarmes et de caractéristiques étendues, et de les retourner aux réglages souhaités.

⁴⁰ See *Chapter 10 - Extended Features, Set Defaults* for additional information.

⁴¹ See *Chapter 9 - Ventilator Alarms, DEFAULTS* for factory-set default values.

DISC/SENSE

When the ventilator detects one of the following conditions, the **DISC/SENSE** alarm is generated:

- When a sense line is pinched or blocked.
- When a sense line has become disconnected.
- When a sense line is occluded (e.g., excessive condensation in the line).

The ventilator detects circuit pressure during the beginning of each inspiration. If an appropriate pressure change is not detected, a **DISC/SENSE** alarm occurs. While the **DISC/SENSE** alarm is active, the ventilator cannot sense the circuit pressure so the breath is terminated.

When a DISC/SENSE alarm occurs:

- Inspiration is immediately terminated and exhalation begins.
- The **DISC/SENSE** message is flashed in the display window.
- The audible alarm is sounded.

To reset the DISC/SENSE alarm:

- 1) Push the Silence / Reset button to silence the alarm.
- 2) Push the Silence / Reset button to reset the alarm.

HIGH f

When the Total Breath Rate (f) exceeds the high breath rate and time period alarm values, the **HIGH f** alarm is generated.

- To prevent nuisance alarms, the **HIGH f** alarm is suspended for the first 60 seconds of ventilator operation after power up and passing the Power On Self Tests.

When a HIGH f alarm occurs:

- The **HIGH f** message is flashed in the display window.
- The audible alarm is sounded.

To reset the HIGH f alarm:

- 1) Push the Silence / Reset button once to silence the audible alarm.
- 2) Push the Silence / Reset button twice to reset the alarm (silences the audible alarm and clears the flashing display).
 - When the **HIGH f** alarm is reset (Silence / Reset button pushed twice), the alarm is suspended for the next 60 seconds.
 - The 60-second suspension of the **HIGH f** alarm is only enabled when the alarm is manually silenced/reset by pushing the Silence / Reset button twice. It is not enabled when the **HIGH f** alarm is automatically silenced/reset because the patient's breath rate no longer exceeds the set **HIGH f** alarm value.

HIGH O₂ PRES (LTV® 1000 Only)

When the average oxygen inlet pressure exceeds the acceptable limit for the type of oxygen source, the **HIGH O₂ PRES** alarm is generated.

- If Low Pressure O₂ Source is selected, the inlet pressure is >10 PSIG.
- If Low Pressure O₂ Source is not selected and the oxygen concentration is set to greater than 21%, the inlet pressure is >85 PSIG.

When the Low Pressure O₂ Source option is selected and a high O₂ pressure source is attached to the ventilator, an Automatic High O₂ Switch Over safety response generates a **HIGH O₂ PRES** alarm, switches the ventilator to High Pressure O₂ Source mode and sets the percentage of oxygen to be delivered in the gas flow to 21%.

When a HIGH O₂ PRES alarm occurs:

- The **HIGH O₂ PRES** message is flashed in the display window.
- The O₂ % (O₂ Flush) control display is flashed.
- The audible alarm is sounded.

To reset the HIGH O₂ PRES alarm:

- 1) Push the Silence / Reset button to silence the alarm.
- 2) Adjust the oxygen inlet pressure.
- 3) Push the Silence / Reset button to reset the alarm.

This alarm is not available in NPPV mode.

WARNING

Disabled Oxygen Inlet Pressure Alarms - When the oxygen blending option is not installed, the Oxygen Inlet Pressure Alarms are disabled.

AVERTISSEMENT

Alarmes de pression d'entrée de l'oxygène désactivées - Lorsque l'option de mélange d'oxygène n'est pas activée, les alarmes de pression d'entrée de l'oxygène sont désactivées.

HIGH PEEP

When the patient circuit positive end expiratory pressure (PEEP) exceeds the High PEEP alarm setting, the **HIGH PEEP** alarm is generated.

When a HIGH PEEP alarm occurs:

- The **HIGH PEEP** message is flashed in the display window.
- The audible alarm is sounded.

To reset the HIGH PEEP alarm:

- 1) Push the Silence / Reset button once to silence the audible alarm.
- 2) Push the Silence / Reset button twice to reset the alarm (silences the audible alarm and clears the flashing display).

High PRES

When the pressure in the patient circuit is greater than the High Pressure Limit setting, the **HIGH PRES** alarm is generated. When this alarm occurs, any inspiration in progress is terminated and the exhalation valve is opened. The turbine is stopped to allow the circuit pressure to evacuate when the high pressure condition persists for more than four times the set inspiratory time or more than 3.0 seconds, whichever is less.

WARNING

Sustained HIGH PRES Alarm - During a sustained High Pressure alarm condition (**HIGH PRES**), the ventilator's turbine is stopped and gas is not delivered to the patient. Disconnect the patient from the ventilator and ventilate the patient using an alternative method. See *Chapter 15 - Troubleshooting, Alarms* for additional information concerning the **HIGH PRES** alarm.

AVERTISSEMENT

Alarme ALARME PMAX continue — Dans des conditions d'alarme de haute pression prolongées (**ALARME PMAX**), la turbine du ventilateur s'arrête et le gaz n'est plus transmis au patient. Débranchez le patient du ventilateur et utilisez une autre méthode de ventilation. Pour plus de détails sur l'état **ALARME PMAX**, reportez-vous au *chapitre 15, Troubleshooting, Alarms*.

Immediate or delayed audible alarms for high pressure conditions can be selected using the Extended Features⁴². If immediate notification is selected, the audible alarm will sound on every high pressure occurrence. If Delayed notification is selected, the audible alarm will sound on the second or third consecutive breath terminated by the **HIGH PRES** alarm. The audible alarm will sound anytime a high pressure condition persists which stops the turbine.

NOTE

The High Pressure alarm output signal is generated by the ventilator's Patient Assist Port for use with Remote Alarm systems. This signal is dependent on the selected setting (**NORMAL** or **PULSE**) in the Extended Features, **PNT ASSIST** menu. See *Chapter 10 - Extended Features, Alarm Operations*, for instructions on setting the Patient Assist Port output signal for use with single or dual tone Remote Alarm systems.

REMARQUE

Le signal de sortie correspondant à l'alarme de pression élevée est généré sur le port d'assistance au patient pour une utilisation avec des systèmes d'alarme à distance. Ce signal dépend du réglage choisi (**NORMAL** ou **IMPULSION**) dans le menu Fonctions avancées, **PNT ASSIST**. Reportez-vous au *chapitre 10, Extended Features, Alarm Operations* pour plus de détails sur le réglage du signal de sortie sur le port d'assistance au patient et sur son utilisation avec des systèmes d'alarme à distance à fréquence simple ou double.

⁴² For more information on selecting the High Pressure Alarm Delay, see *Chapter 10 - Extended Features*.

HIGH PRES (cont.)

The **HIGH PRES** alarm becomes inactive and is automatically silenced using the following criteria:

High Pressure Limit Setting	Circuit Pressure at which HIGH PRES alarm is silenced
31 to 100 cmH ₂ O	Less than 25 cmH ₂ O
8 to 30 cmH ₂ O	More than 5 cmH ₂ O lower than current High Pressure Limit Setting
5 to 7 cmH ₂ O	Less than 2 cmH ₂ O

When a HIGH PRES alarm occurs:

- Inspiration is immediately terminated and exhalation begins.
- The **HIGH PRES** message is flashed in the display window.
- The High Pressure Limit control display is flashed.
- The audible alarm is sounded.

To reset the HIGH PRES alarm:

- 1) Push the Silence / Reset button to silence the alarm.
- 2) Resolve the high pressure problem.
- 3) Push the Silence / Reset button to reset the alarm.

HW FAULT

When the ventilator detects one of the following hardware faults, the **HW FAULT** alarm is generated:

- The cooling fan is not operating, or the fan filter may be blocking the fan (see page 13-2 for cleaning and installation instructions).
- A problem is detected with the analog to digital converters.
- A problem is detected with the flow valve.
- A problem is detected with the processor.
- A problem is detected with the EEPROM memory.
- A problem is detected writing data to the EEPROM during system shutdown.
- A problem is detected with the audible alarm circuitry.
- A problem is detected with the alarm sounder.

The **HW FAULT** alarm may occur as a result of ESD⁴³ or other transient causes. If the problem is temporary, the alarm will automatically silence when the condition clears. If the problem persists, or you experience repeated **HW FAULT** alarms, immediately contact a certified Pulmonetic Systems' service technician or Pulmonetic Systems.

- To determine the type of hardware fault detected by the ventilator, *see Appendix E - Event Trace.*

When a HW FAULT alarm occurs:

- The **HW FAULT** message is flashed in the display window.
- The audible alarm is sounded.

To reset the HW FAULT alarm:

- 1) Push the Silence / Reset button twice.
- 2) If the alarm occurs again, immediately contact a certified Pulmonetic Systems' service technician or Pulmonetic Systems.

This alarm is not available in NPPV mode.

NOTE

Repeated or continuous **HW FAULT** alarms may indicate a hardware failure that could prevent the ventilator from performing within its specifications. Remove the ventilator from service and immediately contact a certified Pulmonetic Systems' service technician or Pulmonetic Systems.

REMARQUE

Des erreurs **HW FAULT** répétitives ou continues peuvent indiquer une panne matérielle qui pourrait empêcher le ventilateur de fonctionner à l'intérieur des limites spécifiées. Retirez le ventilateur du service, et contactez immédiatement un technicien de service certifié de Pulmonetic Systems ou Pulmonetic Systems.

⁴³ Electrostatic Discharge.

INOP

An **INOP** alarm is generated when:

- The ventilator is switched from **On** to **Standby**.
- The ventilator detects any condition that is deemed to make the ventilator unsafe.

When an **INOP** occurs, the ventilator shuts down and sets the hardware to a safe state so the patient can breathe from room air.

When an INOP alarm occurs:

- Inspiratory flow is stopped and the exhalation valve is opened, allowing the patient to breathe spontaneously from room air.
- The oxygen blending solenoids are closed.
- The **INOP** LED is illuminated red.
- The audible alarm is sounded continuously.

To silence the INOP alarm:

- 1) Push the Silence / Reset button to silence the alarm. For ventilators with an audio sound symbol (🔊) on the back panel label, verify a confirming audible chirp occurs after the alarm is silenced⁴⁴.



WARNING

Alternative Ventilation - It is recommended that an alternative means of ventilating the patient be available at all times and that all ventilator operators be fully familiar with emergency ventilation procedures.

INOP Alarm - If an **INOP** alarm occurs during operation, ventilate the patient using an alternative method, disconnect the ventilator, and immediately contact a certified Pulmonetic Systems' service technician or Pulmonetic Systems, Inc.



AVERTISSEMENT

Ventilation alternative - Il est recommandé qu'un moyen alternatif de ventilation soit disponible en tout temps, et que tous les opérateurs de ventilateur soient pleinement familiers avec les procédures de ventilation d'urgence.

Alarme INOP - Si une alarme **INOP** survient au cours de l'opération, ventilez le patient à l'aide de la méthode alternative, retirez immédiatement le ventilateur du service, et contactez immédiatement votre technicien de service certifié de Pulmonetic Systems ou Pulmonetic Systems Inc.

NOTE

An **INOP** alarm is generated as a part of the normal process of switching the ventilator from On to the Standby state and does not indicate a problem with the ventilator. The **INOP** LED will remain lit for a minimum of 5 minutes and does not affect battery life.

REMARQUE

Une alarme **INOP** est générée au cours du processus normal de commutation du ventilateur de la position On (Marche) à la position Standby State (État d'attente), et n'indique pas un problème de fonctionnement du ventilateur. La DEL **INOP** restera allumée durant au moins 5 minutes et n'affecte en rien la durée de vie de la batterie.

⁴⁴ The audible chirp occurs after the Inop Alarm sounds for longer than 0.8 seconds and is then silenced.

LOW MIN VOL

When the exhaled minute volume (VE) is less than the Low Minute Volume setting, the **LOW MIN VOL** alarm is generated.

- To prevent nuisance alarms, the **LOW MIN VOL** alarm is suspended for the first 20 seconds of ventilator operation after power up and passing the Power On Self Tests.

When a **LOW MIN VOL** alarm occurs:

- The **LOW MIN VOL** message is flashed in the display window.
- The Low Minute Volume Control display is flashed.
- The audible alarm is sounded.

To reset the **LOW MIN VOL** alarm:

- 1) Push the Silence / Reset button twice.

This alarm is not available in NPPV mode.

WARNING

Low Minute Volume Control Settings - The Low Minute Volume control should be set to its highest clinically appropriate value. If there is a clinical need to set the Low Minute Volume alarm to lower values or off (" - -"), perform a clinical assessment to determine if an alternative monitor (i.e. a Pulse Oxymeter with an audible alarm, or a Cardio Respiratory Monitor) should be used.

AVERTISSEMENT

Réglages du contrôle de volume bas par minute - Le contrôle du volume bas par minute doit être ajusté à la plus haute valeur clinique appropriée. Si l'alarme de volume bas par minute doit être ajustée à des valeurs inférieures ou mise à l'arrêt (" - -") pour satisfaire aux besoins cliniques, effectuer une évaluation clinique afin de déterminer si l'utilisation d'un autre moniteur (c.-à-d., sphygmo-oxymètre muni d'une alarme sonore ou un moniteur cardio-respiratoire) s'avère pertinente.

LOW O₂ PRES (LTV® 1000 Only)

When the average oxygen inlet pressure is less than the minimum inlet pressure of 35 PSIG, the **LOW O₂ PRES** alarm is generated. This alarm is only active when Low Pressure O₂ Source is not selected and the oxygen concentration is set to greater than 21%.

NOTE

The LTV1000 features an enhanced Low O₂ Pressure Alarm algorithm which allows for a brief, temporary drop out of the low O₂ pressure supply while maintaining delivered O₂ %.

REMARQUE

Le LTV est caractérisé par un algorithme amélioré «alarme de pression d'oxygène basse», lequel permet la chute brève et temporaire de l'approvisionnement de pression d'oxygène basse tout en maintenant le % d'oxygène administré.

When a LOW O₂ PRES alarm occurs:

- The **LOW O₂ PRES** message is flashed in the display window.
- The O₂ % (O₂ Flush) control display is flashed.
- The audible alarm is sounded.

To reset the LOW O₂ PRES alarm:

- 1) Push the Silence / Reset button to silence the alarm.
- 2) Reset the ventilator's oxygen inlet pressure.
- 3) Push the Silence / Reset button to reset the alarm.

This alarm is not available in NPPV mode.

WARNING

Disabled Oxygen Inlet Pressure Alarms - When the oxygen blending option is not installed, the Oxygen Inlet Pressure Alarms are disabled.

AVERTISSEMENT

Alarmes de pression d'entrée de l'oxygène désactivées - Lorsque l'option de mélange d'oxygène n'est pas activée, les alarmes de pression d'entrée de l'oxygène sont désactivées.

LOW PRES

When the peak inspiratory pressure for a selected breath is less than the Low Pressure setting, the **LOW PRES** alarm is generated. The Low Pressure alarm can be set to apply to all breaths (**ALL BREATHS**) or to Volume Control (**VC**) and Pressure Control (**PC**) breaths only. (For information on selecting breath types, see *Chapter 10 - Extended Features, Low Peak Pressure Alarm.*)

When a LOW PRES alarm occurs:

- The **LOW PRES** message is flashed in the display window.
- The Low Pressure Control display is flashed.
- The audible alarm is sounded.

To reset the LOW PRES alarm:

- 1) Push the Silence / Reset button twice.

This alarm is not available in NPPV mode.



WARNING

Patient Circuit Accessories - The use of accessories such as Speaking Valves, Heat-Moisture Exchangers and Filters create additional patient circuit resistance and in the event of a disconnection, may impede the generation of a Low Pressure Alarm. Ensure that the Low Pressure Alarm settings accommodate these types of accessories when used in combination with patient circuits.



AVERTISSEMENT

Accessoires du circuit du patient - L'utilisation d'accessoires tels que les membranes vocales, les échangeurs thermohydriques et les filtres, produit une résistance additionnelle dans le circuit de patient et en cas de débranchement, elle risque d'empêcher la génération de l'alarme de basse pression. S'assurer que les paramètres de l'alarme de basse pression s'adaptent à ces types d'accessoires lorsqu'ils sont utilisés avec les circuits du patient.

NO CAL DATA, NO CAL Monitor Display

When the ventilator detects invalid or missing calibration records on power up, the **NO CAL DATA** alarm is generated. When this happens, default calibration values are used, and although the ventilator will continue to operate, the accuracy of volumes and pressures may be reduced.

A **NO CAL** message is posted in place of affected monitored values when the ventilator is operating without valid transducer calibration data.

When the NO CAL DATA alarm occurs:

- The **NO CAL DATA** message is flashed in the display window.
- The audible alarm is sounded.
- The ventilator continues to operate.
- Default transducer data is used.
- Vte, PIP, MAP, PEEP, and VE monitored values are displayed as **NO CAL**.

To clear the NO CAL DATA alarm:

- 1) Push the Silence / Reset button twice. This will clear the alarm and the ventilator will continue to operate; however, the **NO CAL** message will still be displayed in place of affected monitored values.
- 2) Take the unit out of service and perform the Calibration procedure⁴⁵.

To clear the NO CAL message:

- 1) Take the unit out of service and perform the Calibration procedure⁴⁵.

WARNING

NO CAL Condition - Operation of the LTV[®] Series ventilator under a **NO CAL** condition may result in inaccurate pressure and volume measurements. Should this condition occur, disconnect the patient from the ventilator, provide an alternative method of ventilation and immediately contact a certified Pulmonetic Systems' service technician or Pulmonetic Systems, Inc.

AVERTISSEMENT

Condition NO CAL - L'opération continue du ventilateur de la série LTV[®] sous condition **NO CAL** peut résulter en mesures de pression et de volume erronées. Si cette condition se présente, le ventilateur doit être retiré du service, et vous devez immédiatement contacter votre technicien de service certifié de Pulmonetic Systems ou Pulmonetic Systems Inc.

⁴⁵ For more information on the Calibration procedure, see the *LTV[®] Series ventilator Service Manual*.

POWER LOST

When the ventilator operates on external power and switches to the internal battery, the **POWER LOST** alarm is generated. The change to internal battery is made when the external power voltage drops below the usable level. There is no interruption in ventilation.

When a POWER LOST alarm occurs:

- The **POWER LOST** message is flashed in the display window.
- The **External Power** and **Charge Status** LEDs are turned off.
- The **Battery Level** LED is lit showing the internal battery charge level.
- The ventilator begins operating from the internal battery.
- The audible alarm is sounded.
- After 60 seconds, the displays are turned off to conserve battery power.⁴⁶

To reset the POWER LOST alarm:

- 1) Push the Silence / Reset button twice.

⁴⁶ To turn the displays on, push any button or turn the Set Value knob.

POWER LOW

When the ventilator is operating on external power and the voltage drops to the low level, the **POWER LOW** alarm is generated.

When a POWER LOW alarm occurs:

- The **POWER LOW** message is flashed in the display window.
- The **External Power** LED is displayed amber.
- The audible alarm is sounded.

To reset the POWER LOW alarm:

- 1) Push the Silence / Reset button twice.

This alarm is not available in NPPV mode.

REMOVE PTNT

When the ventilator is powered up in the Ventilator Checkout or Ventilator Maintenance modes, the **REMOVE PTNT** alarm is generated to remind you to remove the patient from the ventilator before proceeding. Use the Ventilator Checkout mode to check for correct operation of the displays and controls and to check the patient circuit for leaks. Ventilator Maintenance mode is used by technical personnel to perform maintenance or calibration.

WARNING

Ventilator Checkout and Maintenance Modes - The LTV[®] Series ventilator does not deliver gas during the Ventilator Checkout mode (**VENT CHECK**) or Ventilator Maintenance mode (**VENT MTNCE**) and should not be used to ventilate a patient during these tests.

AVERTISSEMENT

Modes Vérification et Entretien du ventilateur - Le ventilateur de la série LTV[®] ne transmet pas le mélange de gaz en mode Vérification du ventilateur (**VENT CHECK**) ou en mode Entretien du ventilateur (**VENT MTNCE**), il ne devrait donc pas être utilisé pour ventiler un patient durant l'exécution de ces tests.

When you enter Ventilator Checkout mode or Ventilator Maintenance mode, a REMOVE PTNT alarm occurs:

- The **REMOVE PTNT** message is displayed.
- The audible alarm is sounded.

To reset the REMOVE PTNT alarm:

- 1) Push the Silence / Reset button twice.

RESET

A **RESET** alarm occurs if the ventilator restarts following a condition other than being shut down by pressing the On/Standby button.

The ventilator runs an ongoing set of self-tests to verify that it is operating correctly. If the ventilator detects a condition that makes safe ventilator operation uncertain, it reinitializes itself to allow the more sophisticated Power On Self Tests (POST) to be performed. If the POST does not detect any further problems, the ventilator will resume operation and a **RESET** alarm is posted. If the POST detects a problem that could cause continued operation to be unsafe, a ventilator **INOP** will occur.

Conditions that could cause a RESET alarm:

- Operating the ventilator on the internal battery until it is fully depleted.
- Electrostatic Discharge (ESD)
- Other transient causes.

When a RESET alarm is generated:

- An error code is written to the Event Trace indicating the type of problem detected.
- The ventilator resets itself and performs the Power On Self Tests (POST).
- If no further problems are detected, the ventilator resumes operation.
- The RESET message is flashed in the display window.
- The audible alarm is sounded.

To reset the RESET alarm:

- 1) Push the Silence / Reset button twice.

This alarm is not available in NPPV mode.

NOTE

When a **RESET** alarm has occurred, check the Event Trace for more information about the problem. See *Appendix E - Event Trace* for more information about events.

Repeated occurrences of the **RESET** alarm may indicate a problem with the ventilator's hardware. Please immediately contact a certified Pulmonetic Systems' service technician.

REMARQUE

Lorsqu'une alarme **Remise à zéro** se produit, vérifiez le suivi de l'événement pour obtenir plus d'informations sur le problème. Consultez l'Annexe E - Suivi de l'événement, pour plus d'informations à propos de l'événement.

Des occurrences répétitives de l'alarme **Remise à zéro** peuvent indiquer un problème matériel avec le ventilateur. Veuillez contacter immédiatement un technicien de service certifié de Pulmonetic Systems.

XDCR FAULT

When a transducer autozero test fails, the **XDCR FAULT** alarm is generated. Transducer autozeros are scheduled at periodic intervals during ventilator operation. This allows the ventilator to adjust the zero pressure readings as the ventilator warms up and environmental conditions change. If an autozero test fails, it will be automatically rescheduled to run again on the next breath. The **XDCR FAULT** alarm will remain active until a valid autozero can be done. If the **XDCR FAULT** persists, remove the ventilator from service and immediately contact a certified Pulmonetic Systems' service technician or Pulmonetic Systems.

When a XDCR FAULT alarm occurs:

- The autozero for the transducer is rescheduled to run again on the next breath.
- The **XDCR FAULT** message is flashed in the display window.
- The audible alarm is sounded.

To reset the XDCR FAULT alarm:

- 1) Push the Silence / Reset button twice.

This alarm is not available in NPPV mode.

WARNING

XDCR FAULT alarm - Continued operation of the LTV® Series ventilator with an activated **XDCR FAULT** alarm may result in inaccurate flow and volume measurements. Should this condition occur, disconnect the patient from the ventilator, provide an alternative method of ventilation and immediately contact a certified Pulmonetic Systems' service technician or Pulmonetic Systems, Inc.

AVERTISSEMENT

Alarme XDCR FAULT - L'opération continue du ventilateur de la série LTV® avec une alarme **XDCR FAULT** activée peut résulter en mesures de débit et de volume erronées. Si cette condition se présente, le ventilateur doit être retiré du service, et vous devez immédiatement contacter votre technicien de service certifié de Pulmonetic Systems ou Pulmonetic Systems Inc.

NOTE

Repeated or continuous **XDCR FAULT** alarms may indicate a problem with the ventilator that could prevent the ventilator from performing within its specifications. Discontinue use of the ventilator and immediately contact a certified Pulmonetic Systems' service technician.

REMARQUE

Des alarmes **XDCR FAULT** répétitives ou continues peuvent indiquer un problème qui pourrait empêcher le ventilateur de fonctionner à l'intérieur des limites spécifiées. Retirer le ventilateur du service, et contactez immédiatement un technicien de service certifié de Pulmonetic Systems.

Alarm Status Messages

f PEEP OFF

The **f PEEP OFF** message is displayed when;

- The High Breath Rate alarm is turned off by being set to HIGH f OFF and,
- The High PEEP alarm is turned off by being set to HI PEEP OFF.

This is an informational message only. The message is displayed at power up, when monitored data is being scrolled automatically, and when no front panel activity is detected for 60 seconds.

To clear the f PEEP OFF message:

- 1) Push any front panel button or turn the Set Value knob.

HI PEEP OFF

The **HI PEEP OFF** message is displayed when;

- The High PEEP alarm is turned off by being set to HI PEEP OFF and,
- The High Breath Rate alarm (HIGH f) is turned on.

This is an informational message only. The message is displayed at power up, when monitored data is being scrolled automatically, and when no front panel activity is detected for 60 seconds.

To clear the HI PEEP OFF message:

- 1) Push any front panel button or turn the Set Value knob.



WARNING

Accuracy of PEEP setting - Variations in the patient's breathing pattern and/or leaks in the patient circuit (including leaks around the tracheostomy tube cuff) can affect PEEP. PSI recommends that the clinician set the PEEP to the prescribed level on a test lung while observing the PEEP value in the LTV display window. The clinician should also periodically monitor the PEEP value in the LTV display window. Using an inaccurate PEEP setting due to a patient leak can result in less than prescribed PEEP or undesirable increases in patient circuit pressure when the patient circuit leak changes.



AVERTISSEMENT

Exactitude du paramètre PEP – Les écarts dans le mode de respiration du patient et/ou les fuites du circuit du patient (y compris les fuites autour du ballonnet pour canule de trachéostomie) peuvent affecter le PEP. Des études et investigations préliminaires recommandent que le clinicien définisse le PEP au niveau prescrit sur un poumon d'essai tout en observant la valeur PEP de l'écran graphique LTV. Le clinicien doit par ailleurs surveiller de façon périodique la valeur PEP de l'écran graphique LTV. L'utilisation d'un paramètre PEP inapproprié en raison d'une fuite de patient peut potentiellement résulter en un paramètre inférieur au paramètre PEP prescrit ou en une augmentation indésirable de la pression du circuit du patient lorsque la fuite du circuit du patient change

HIGH f OFF

The **HIGH f OFF** message is displayed when;

- The High Breath Rate alarm is turned off by being set to HIGH f OFF and,
- The High PEEP alarm (HIGH PEEP) is turned on.

This is an informational message only. The message is displayed at power up, when monitored data is being scrolled automatically, and when no front panel activity is detected for 60 seconds.

To clear the HIGH f OFF message:

- 1) Push any front panel button or turn the Set Value knob.

LMV LPPS OFF

The **LMV LPPS OFF** message is displayed when;

- The Low Minute Volume alarm is turned off by being set to dashes and,
- The LPP alarm is set to VC/PC ONLY. When this setting is selected, the Low Pressure alarm applies only to Volume Control and Pressure Control breaths.

This is an informational message only. The message is displayed at power up, when monitored data is being scrolled automatically, and when no front panel activity is detected for 60 seconds.

To clear the LMV LPPS OFF message:

- 1) Push any front panel button or turn the Set Value knob.

This message is not displayed in NPPV mode.

LMV OFF

The **LMV OFF** message is displayed when;

- The Low Minute Volume alarm is turned off by being set to dashes and,
- The LPP alarm is set to ALL BREATHS.

This is an informational message only. The message is displayed at power up, when monitored data is being scrolled automatically, and when no front panel activity is detected for 60 seconds.

To clear the LMV OFF message:

- 1) Push any front panel button or turn the Set Value knob.

This message is not displayed in NPPV mode.

LOCKED

The **LOCKED** message is displayed when a button is pushed while the controls are locked. No audible alarm is given.

When a LOCKED message is displayed:

- The **LOCKED** message is flashed in the display window for 5 seconds or until the controls are unlocked.
- Control settings may not be changed.

There are two methods for unlocking the controls: EASY and HARD. The unlock method is selected under the Extended Features menus⁴⁷.

To unlock the controls with EASY unlocking:

- 1) Push the Control Lock button.

To unlock the controls with HARD unlocking:

- 1) Push and hold the Control Lock button for 3 seconds.

LPPS OFF

The **LPPS OFF** message is displayed when;

- The LPPS alarm is set to VC/PC ONLY (when this setting is selected, the Low Pressure alarm applies only to Volume Control and Pressure Control breaths), and,
- The LMV alarm is not set to dashes “- -”.

This is an informational message only. The message is displayed at power up, when monitored data is being scrolled automatically, and when no front panel activity is detected for 60 seconds.

To clear the LPPS OFF message:

- 1) Push any front panel button or turn the Set Value knob.

This message is not displayed in NPPV mode.

⁴⁷ See *Chapter 10 - Extended Features, Control Unlock* for more information.

WARMUP xx

When the ventilator is first powered up, the transducers require up to 60 seconds of warm-up time before they will operate within their normal tolerances. During this warm-up period, the ventilator will not allow you to run the leak test or calibration. If you select an option that is not available during the warm-up period, the **WARMUP xx** message is displayed. When the warm-up period has expired, the message is removed.

When a WARMUP message occurs:

- The **WARMUP** message and the remaining warm-up time are displayed in the window.
- The ventilator does not allow the restricted functions to be performed.

To reset the WARMUP message:

- 1) The WARMUP message will automatically reset when the warm-up period has expired.

Chapter 10 - EXTENDED FEATURES

This section describes the options and features available under the Extended Features Menu and how to access them.

The Extended Features shown below are representative of an LTV® 1000 ventilator. Refer to the descriptions of specific options or features contained in this chapter for their applicability to other LTV® ventilator models.

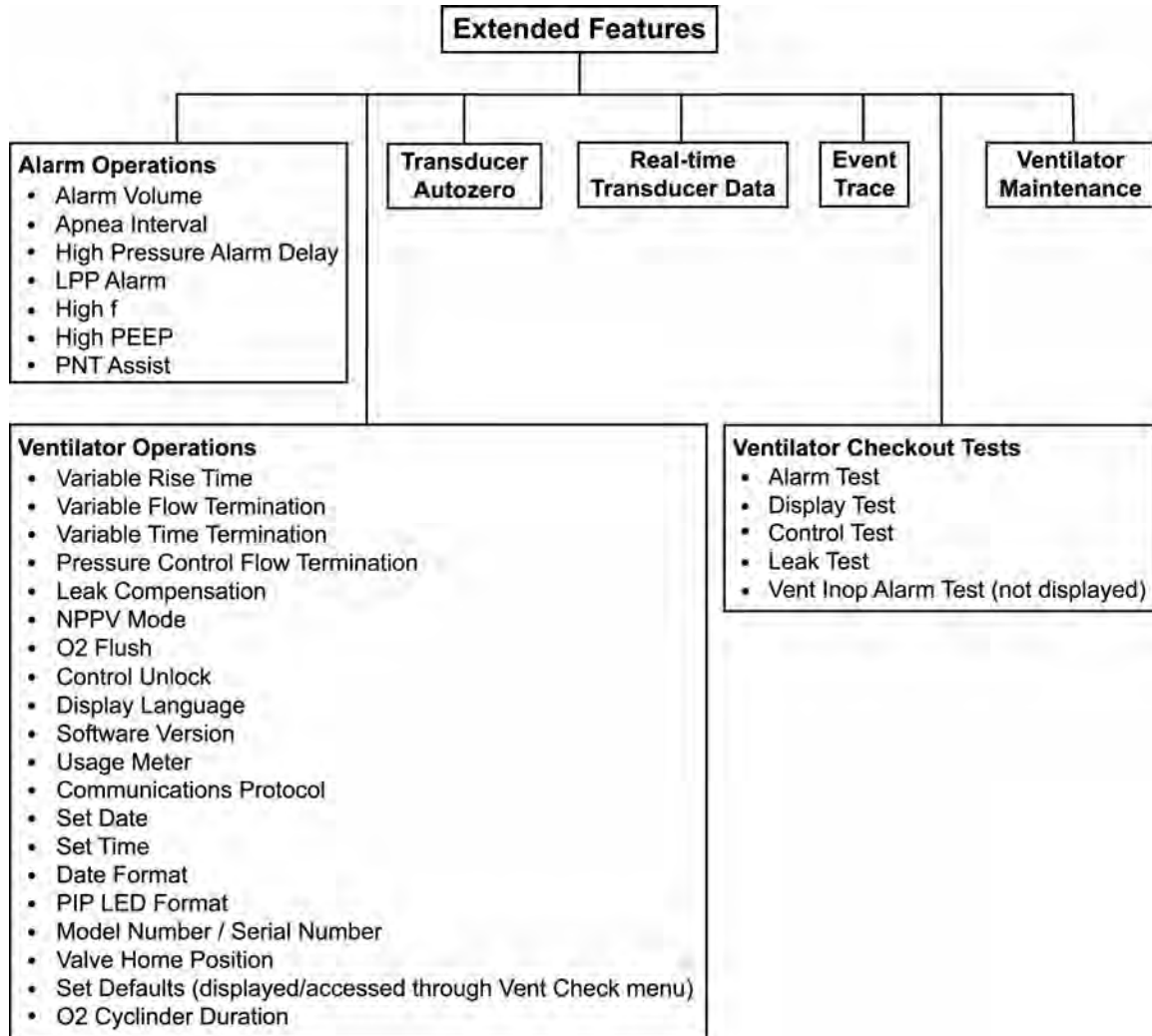

Alarm Operations, Ventilator Operations, Transducer Autozero and Real-time Transducers are covered in this chapter. The other items are covered in *Chapter 11 - Ventilator Checkout Tests*, *Appendix E - Event Trace*, and in the LTV® Series ventilator *Service Manual* (P/N 10665).

Navigating the Extended Features Menus

To enter the Extended Features menu (in normal ventilation mode):

Push and hold the Select button for three seconds.

To view the next item in a menu:

Turn the Set Value knob clockwise.

To view the previous item:

Turn the Set Value knob counterclockwise.

To enter a menu item or select a setting:

Push the Select button.

To exit a menu:

Turn the Set Value knob until the **EXIT** option is displayed, then push the Select button.

To toggle the state of an option on or off:

Push the Select button.

NOTE

You cannot enter the Extended Features menu when the controls are locked.

REMARQUE

Vous ne pouvez pas accéder au menu Fonctions avancées lorsque le verrouillage est activé.

Alarm Operations

Use the Alarm Operations menu to set up alarm conditions that are not available directly from front panel controls. The menu is set up as follows:

ALARM OP

ALARM VOL

APNEA INT

HP DELAY

LPP ALARM

HIGH f

HIGH PEEP

PNT ASSIST

EXIT

Alarm Volume

Use this menu item to set the loudness of the audible alarm.

To modify the Alarm Volume:

- 1) Push the Select button while **ALARM VOL** is displayed.
- 2) **VOL xx dBA** is displayed.
- 3) Turn the Set Value knob until the desired setting is displayed.
- 4) Push the Select button.

Range: 60 - 85 dBA at one meter

NOTE

Fixed Volume Alarms – The volume of the Battery Empty alarm cannot be lowered. For patient safety, this alarm always sounds at full volume.

If the battery depletes to point that the ventilator goes INOP, the Vent INOP audible alarm sounds at maximum volume for a minimum of 5 minutes. The Vent INOP audible alarm is capacitor driven and the volume is therefore not user modifiable.

REMARQUE

Alarmes à volume fixe - Le volume de l'alarme de batterie faible ne peut être réduit. Pour la sécurité des patients, le volume de cette alarme est toujours fort.

Si la batterie est suffisamment déchargée pour que le voyant INOP du ventilateur s'active, l'alarme sonore Vent INOP opérera à son maximum de volume pendant 5 minutes au moins. L'alarme sonore Vent INOP est contrôlée par un condensateur et son volume ne peut donc pas être modifié par l'utilisateur..

Apnea Interval

Use this menu item to establish the apnea interval. The apnea interval is the maximum time allowed between the beginning of one breath and the beginning of the next breath.

To modify the Apnea Interval:

- 1) Push the Select button while **APNEA INT** is displayed.
- 2) **APNEA xx sec** is displayed.
- 3) Turn the Set Value knob until the desired setting is displayed.
- 4) Push the Select button.

Range: 10 - 60 sec

High Pressure Alarm Delay

Use this menu item to select immediate or delayed audible notification for High Pressure Alarms.

When **NO DELAY** is selected, the audible alarm is sounded for all High Pressure alarms.

When **DELAY 1 BRTH** or **DELAY 2 BRTH** is selected and a high pressure condition occurs, the breath is terminated and the **HIGH PRES** message is posted. The audible alarm is not sounded until the number of consecutive breaths with a high pressure condition meets the delay setting, (two breaths for **DELAY 1**, three breaths for **DELAY 2**).

Any time a high pressure condition persists for more than 3 seconds, the audible alarm will be sounded, regardless of the delay setting.

To modify the High Pressure Alarm Display:

- 1) Push the Select button while **HP DELAY** is displayed.
- 2) **NO DELAY, DELAY 1 BRTH, or DELAY 2 BRTH** is displayed.
- 3) Turn the Set Value knob until the desired setting is displayed.
- 4) Push the Select button.

Options: NO DELAY, DELAY 1 BRTH, DELAY 2 BRTH

Low Peak Pressure Alarm

Use the **LPP ALARM** item to select the type of breaths that the Low Pressure alarm applies to.

When **ALL BREATHS** is selected, the Low Pressure alarm setting applies to all breath types: Volume Control, Pressure Control, Pressure Support, and Spontaneous. When the peak pressure during any breath does not exceed the Low Pressure setting, the **LOW PRES** alarm will occur.

When **VC/PC ONLY** is selected, the Low Pressure alarm setting applies only to Volume Control and Pressure Control breaths. It does not apply to Pressure Support and Spontaneous breaths. When the peak pressure during any Volume Control or Pressure Control breath does not exceed the Low Pressure setting, the **LOW PRES** alarm will occur.

Options: ALL BREATHS, VC/PC ONLY

High f

Use this menu item to set the high breath rate and time period alarm values. When the Total Breath Rate (f) exceeds the set high breath rate and time period alarm values, an audible alarm will be sounded and a flashing **HIGH f** message will be displayed.

To set the high breath rate and time period alarm values:

- 1) Push the Select button while **HIGH f** is displayed and **f** is displayed.
- 2) Push the Select button while **f** is displayed and **HIGH f OFF** or **f xx bpm** is displayed.
- 3) Turn the Set Value knob until the desired setting is displayed, push the Select button and the high breath rate alarm value is set.
 - **Range:** 5 - 80 bpm (in increments of 1) - HIGH f OFF
- 4) Turn the Set Value knob until **TIME** is displayed, push the Select button and **xx sec** is displayed.
- 5) Turn the Set Value knob until the desired setting is displayed and push the Select button. The high breath rate time period alarm value is set.
 - **Range:** 0 - 60 seconds, in increments of 10

High PEEP

Use this menu item to set a high PEEP alarm value. When the current PEEP value exceeds the set high PEEP alarm value, an audible alarm will be sounded and a flashing **HIGH PEEP** message will be displayed.

To set the high PEEP alarm value:

- 1) Push the Select button while **HIGH PEEP** is displayed.
- 2) **HI PEEP OFF** or **PEEP xx cmH₂O** is displayed.
 - **HI PEEP OFF** is the factory set default setting.
- 3) Turn the Set Value knob until the desired setting is displayed.
- 4) Push the Select button.

Range: 3 - 40 cmH₂O (in increments of 1) - HI PEEP OFF

Patient Assist

Use the **PNT ASSIST** menu item to configure the Patient Assist port output signal to be generated for use with remote alarm systems.

- Allows for the changing of the patient assist alarm output signal used with remote alarm systems, which in turn will allow users a means of distinguishing the high pressure alarm (**HIGH PRES**) from other alarms.

To select the Patient Assist output signal:

- 1) Push the Select button while **PNT ASSIST** is displayed.
- 2) **NORMAL** or **PULSE** is displayed.
 - When **NORMAL** is selected, the ventilator sets the Patient Assist Port output signal continuously on for all alarms and is for use with single tone remote alarm and patient assist call systems. **NORMAL** is the factory set default setting.
 - When **PULSE** is selected, the ventilator sets the Patient Assist Port output signal continuous on for the **HIGH PRES** alarm, cycles the Patient Assist output signal on / off for all other alarms and is for use with dual tone remote alarm systems.
- 3) Turn the Set Value knob until the desired setting is displayed.
- 4) Push the Select button.

Range: PULSE or NORMAL

Exit

To return to the top of the ALARM OP menu:

- 1) Push the Select button while **EXIT** is displayed.

Vent Operations

Use the Vent Operations menu to set up ventilator controls and options that are not available directly from front panel controls. The menu is set up as follows:

VENT OP

RISE TIME

FLOW TERM

TIME TERM

PC FLOW TERM

LEAK COMP

NPPV MODE

O₂ FLUSH⁴⁸

CTRL UNLOCK

LANGUAGE

VER xx.xx X

USAGE xxxxx.x

COM SETTING

SET DATE

SET TIME

DATE FORMAT

PIP LED

LTV xxxx / xxxxxx

VHome xxx

SET DEFAULTS (accessed through Vent Check menu)

O₂ CYL DUR⁴⁸

EXIT

⁴⁸ O₂ Flush and O₂ Cylinder Duration options are only available on LTV®1000 ventilators.

Variable Rise Time

Use the Variable Rise Time option to select the rise time profile for Pressure Control and Pressure Support breaths. The rise time profiles are numbered 1 through 9 where 1 is the fastest rise time and 9 is the slowest rise time. Starting with the fastest rise time, each time is 33% longer than the previous one.

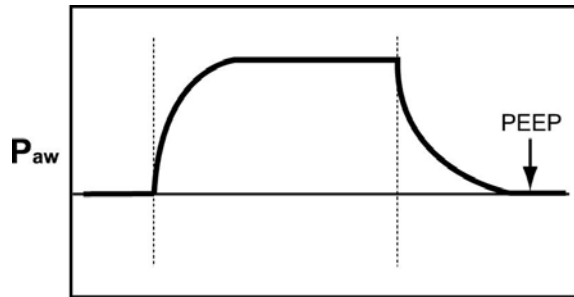

Profile #1 - Faster Rise Time

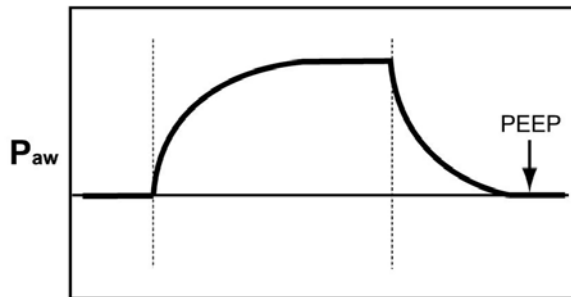

Profile #9 - Slower Rise Time

To modify the Rise Time Profile:

- 1) Push the Select button while **RISE TIME** is displayed.
- 2) **PROFILE x** is displayed.
- 3) Turn the Set Value knob until the desired Rise Time Profile is displayed.
- 4) Push the Select button.

Range: 1 to 9, where 1 is the fastest and 9 is the slowest

Variable Flow Termination

Use the Variable Flow Termination to select the percentage of peak flow used for cycling Pressure Support breaths. Pressure Support breaths are cycled from inspiration to exhalation when the flow reaches the set percentage of the peak flow, or when flow goes below 2 lpm.

When Pressure Control Flow Termination is enabled, the Variable Flow Termination setting is used for flow termination of Pressure Control breaths as well.

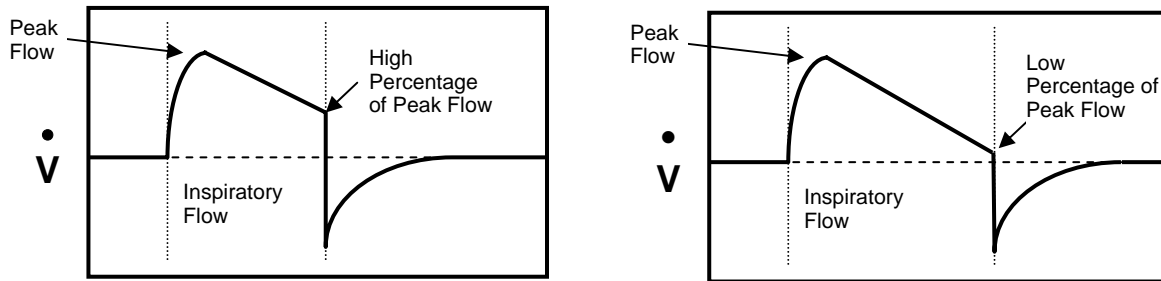

To modify the Variable Flow Termination:

- 1) Push the Select button while **FLOW TERM** is displayed.
- 2) **% OF PEAK xx** is displayed.
- 3) Turn the Set Value knob until the desired Variable Flow Termination percentage is displayed.
- 4) Push the Select button.

Range: 10% to 40%

Variable Time Termination

Use the Variable Time Termination to select the maximum inspiratory time for cycling Pressure Support breaths. Pressure Support Breaths are cycled from inspiration to exhalation if this time is reached before the flow reaches the set percentage of the peak flow. When a breath is cycled based on the time setting, the Pressure Support display is flashed briefly.

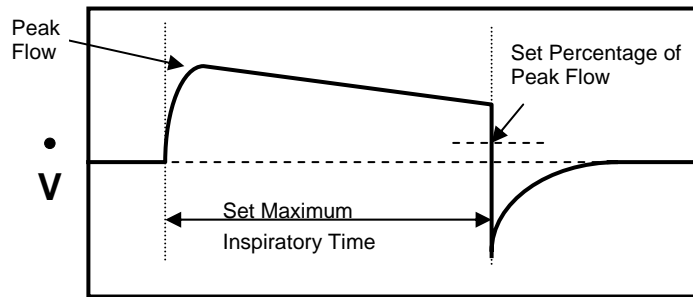

To modify the Variable Time Termination:

- 1) Push the Select button while **TIME TERM** is displayed.
- 2) **TERM x.x sec** is displayed.
- 3) Turn the Set Value knob until the desired Variable Time Termination is displayed.
- 4) Push the Select button.

Range: 0.3 to 3.0 sec

Pressure Control Flow Termination

Use the Pressure Control Flow Termination option to enable or disable flow termination for Pressure Control breaths.

When this option is ON, Pressure Control breaths are cycled at the set percentage of the peak flow if it is reached before the set Inspiratory Time elapses. The percentage of peak flow is set in the Variable Flow Termination option.

When this option is OFF, Pressure Control breaths are cycled when the set Inspiratory Time is reached.

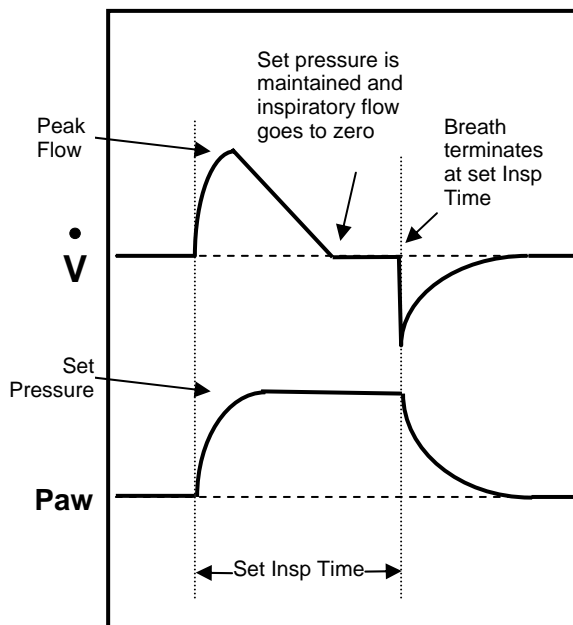

PC FLOW TERM set to OFF

Pressure Control Breath terminates normally

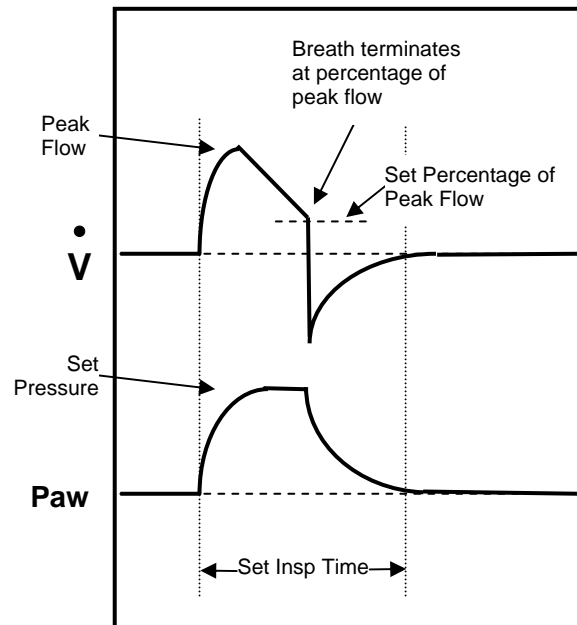

PC FLOW TERM set to ON

Pressure Control Breath terminates at the same Percentage of Peak Flow as Pressure Support breaths

To modify the Pressure Control Flow Termination setting:

- 1) Push the Select button while **PC FLOW TERM** is displayed.
- 2) **PC FLOW ON** or **PC FLOW OFF** is displayed.
- 3) Turn the Set Value knob until the desired state is displayed.
- 4) Push the Select button.

Options: ON or OFF

Leak Compensation

Use the Leak Compensation option to enable or disable tracking of the baseline flow⁴⁹ to improve triggering when a circuit leak is present.

When Leak Compensation is on, the system is gradually adjusted to maintain set sensitivity if the leak is stable and there is no autocycling.

- If a leak is unstable during exhalation, it will not be detected and will not be compensated for.
- Leak Compensation can compensate for a maximum patient circuit leak of 6 Lpm.

If autocycling is occurring, it can be manually eliminated as follows:

- 1) Set sensitivity to **OFF** (see *Chapter 6 - Sensitivity*), or higher than the leak amount (see *Chapter 10 - Real Time Transducers, LEAK xx.xx Lpm*).
- 2) Set Leak Compensation to **LEAK COMP ON** (see instructions below).
- 3) Wait for a period of 10-15 breaths.
- 4) Reset sensitivity to desired level (see *Chapter 6 - Sensitivity*).

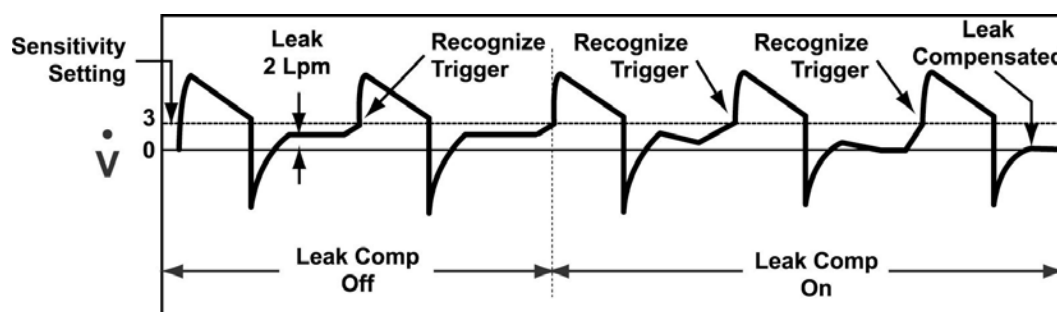

Leak Compensation - Off to On

To modify the Leak Compensation setting:

- 1) Push the Select button while **LEAK COMP** is displayed.
- 2) **LEAK COMP ON** or **LEAK COMP OFF** is displayed.
- 3) Turn the Set Value knob until the desired state is displayed.
- 4) Push the Select button.

Options: ON or OFF

⁴⁹ Baseline flow is used for flow triggering detection and Vte calculation/accumulation.

NPPV Mode

Use the NPPV Mode option to enable or disable Non-invasive Positive Pressure Ventilation (**NPPV**) mode. When NPPV Mode is selected, the **NPPV** Mode LED on the front panel is lit. For more information on NPPV mode, see *Chapter 4 - Ventilation Modes*, NPPV.

WARNING

NPPV Mode - NPPV⁵⁰ is not a life support mode and is not suitable for patients that require life support ventilation. NPPV Mode should only be used for supplemental ventilation of non-life support patients.

NPPV Mode - When operating in NPPV⁵⁰ mode, many of the standard alarms are disabled. This may result in reduced ventilation accuracy should a problem occur. Carefully read *Chapter 4 - Ventilation Modes*,

NPPV, before selecting this mode of operation.

AVERTISSEMENT

Mode NPPV – Le mode NPPV n'est pas un mode de maintien des fonctions vitales continu et il n'est pas approprié pour les patients qui ont besoin d'une ventilation continue pour le maintien des fonctions vitales. Le mode NPPV ne doit être utilisé que comme ventilation supplémentaire pour les patients qui ne nécessitent pas de maintien des fonctions vitales.

Mode NPPV – Lorsque l'appareil fonctionne en mode NPPV, bon nombre des alarmes standards sont désactivées. Par conséquent, si un problème survient, la précision de la ventilation pourrait diminuer. Assurez-vous de lire attentivement le chapitre 4 – Types de respiration et modes de ventilation, mode NPPV avant de choisir ce mode de fonctionnement.

To modify the NPPV Mode setting:

- 1) Push the Select button while **NPPV MODE** is displayed.
- 2) **NPPV MODE ON** or **NPPV MODE OFF** is displayed.
- 3) Turn the Set Value knob until the desired state is displayed.
- 4) Push the Select button.

Options: ON or OFF

⁵⁰ Non-Invasive Positive Pressure Ventilation.

O₂ Flush (LTV® 1000 Only)

Use the O₂ Flush option to elevate the delivered FIO₂ to 100% for a preset period of time.

To initiate an O₂ Flush:

- 1) Push and hold the **O₂ % (O₂ Flush)** button (FIO₂) on the ventilator front panel for three seconds to initiate the elevation (ramp up) of delivered FIO₂ to 100% for the preset number of minutes.
 - The FIO₂ percentile displayed will change to 100 and the O₂ Flush maneuver will start immediately (regardless of the current ventilation mode, breath rate or phase).
 - O₂ Flush will not be initiated if Low O₂ Source is selected.
 - O₂ Flush will stop when the preset minutes have elapsed or the **O₂ % (O₂ Flush)** button is pushed again.
 - When stopped, the delivered FIO₂ percentile will return (ramp down) to the preset O₂ % setting.

To modify the O₂ Flush setting:

- 1) Push the Select button while **O₂ FLUSH** is displayed and **xxx min** is displayed.
- 2) Turn the Set Value knob until the desired amount of minutes is displayed, and push the Select button. The O₂ Flush time period is set.

Range: 1 to 3 minutes, in increments of 1

Control Unlock

Use the Control Unlock option to select the Easy or Hard unlocking method for unlocking the controls. The Easy unlocking method should be used when only trained personnel have access to the ventilator. The Hard method should be used when children or others may have access to the ventilator and you want to prevent accidental changes to the control settings.

When the Easy method is selected, unlock the controls by pushing the Control Lock button.

When the Hard method is selected, unlock the controls by pushing and holding the Control Lock button for 3 seconds.

To modify the Control Unlock setting:

- 1) Push the Select button while **CTRL UNLOCK** is displayed.
- 2) **UNLOCK EASY** or **UNLOCK HARD** is displayed.
- 3) Turn the Set Value knob until the desired setting is displayed.
- 4) Push the Select button.

Options: EASY or HARD

Language Selection

Use the Language Selection option to select the language used in the display window for all messages, alarms and menus.

To modify the Language setting:

- 1) Push the Select button while **LANGUAGE** is displayed.
- 2) **ENGLISH** or the currently selected language is displayed.
- 3) Turn the Set Value knob until the desired language is displayed.
- 4) Push the Select button.

Options:

ENGLISH (U.S.)	DANSK (Danish)	DEUTCH (German)	ESPAÑOL (Spanish)	FRANCAIS (French)
ITALIANO (Italian)	NORSK (Norwegian)	PORTUGUES (Portuguese)	SVENSKA (Swedish)	РУССКОЕ (Russian)

Software Version

Use the Software Version option to verify the software version installed in the ventilator. The software version number is displayed as: **VER xx.xx X**

Usage Meter

Use the Usage Meter to view the time the ventilator has been in use. It is updated every 1/10th hour up to 139,000.0 hours and is displayed as: **USAGE xxxxxx.x**

Communications Setting

The ventilator may be connected to a printer, a graphics monitor, or a modem, or may be set up to output system diagnostic data. Use the Communications Setting option⁵¹ to select the communications protocol for data transmission.

- For LTM™ Compatible LTV® 900, 950 and 1000 Ventilators⁵², use the **MONITOR** setting to communicate with an LTM Graphics Monitor. If the **MONITOR** setting is not available, the LTV® ventilator being used requires upgrades before it can support the LTM Graphics Monitor. Contact your Pulmonetic Systems Service Representative for additional information.

To modify the Communications Setting:

- 1) Push the Select button while **COM SETTING** is displayed.
- 2) **DATA** or the currently selected protocol is displayed.
- 3) Turn the Set Value knob until the desired protocol is displayed.
- 4) Push the Select button.

Options: DATA, MONITOR, PRINTER, and MODEM

⁵¹ Only **DATA** and **MONITOR** (for LTM Graphic Monitors compatible LTV® Ventilators) are available at this time.

⁵² LTM Graphics Monitor compatibility can be verified by pushing the Select button when the **LTV Model Number** is displayed in the Extended Features menu. The message **LTM** will be displayed if the ventilator was originally manufactured or upgraded by Pulmonetic Systems to accommodate the LTM Graphics Monitor.

Set Date

Use the Set Date option to view or set the current date stored in the ventilator.

To view the Date:

- 1) Push the Select button while **SET DATE** is displayed.
- 2) The current date is displayed in the currently selected date format.
- 3) Push the Control Lock button to exit.

To modify the Date:

- 1) Push the Select button while **SET DATE** is displayed.
- 2) The current date is displayed in the currently selected date format (**MM/DD/YYYY**, **DD/MM/YYYY**, or **YYYY/MM/DD**).
- 3) Push the Select button, **YEAR xxxx** is displayed.
- 4) Turn the Set Value knob until the desired year is displayed.
- 5) Push the Select button, **MONTH xx** is displayed.
- 6) Turn the Set Value knob until the desired month is displayed.
- 7) Push the Select button, **DAY xx** is displayed.
- 8) Turn the Set Value knob until the desired day is displayed.
- 9) Push the Select button to accept the new date.

Range: 1/1/1998 - 12/31/2097

Set Time

Use the Set Time option to view or set the current time stored in the ventilator.

To view the Time:

- 1) Push the Select button while **SET TIME** is displayed.
- 2) The current time is displayed.
- 3) Push the Control Lock button to exit.

To modify the Time:

- 1) Push the Select button while **SET TIME** is displayed.
- 2) The current date is displayed as **hh:mm:ss**.
- 3) Push the Select button, **HOUR xx** is displayed.
- 4) Turn the Set Value knob until the desired hour is displayed.
- 5) Push the Select button, **MIN xx** is displayed.
- 6) Turn the Set Value knob until the desired minute is displayed.
- 7) Push the Select button to accept the new date. The seconds are automatically reset to 00.

Range: 00:00:00 - 23:59:59

Date Format

Use the Date Format option to select the display format for the current date.

To modify the Date Format:

- 1) Push the Select button while **DATE FORMAT** is displayed.
- 2) **MM/DD/YYYY** or the currently selected date format is displayed.
- 3) Turn the Set Value knob until the desired format is displayed.
- 4) Push the Select button.

Options: MM/DD/YYYY, DD/MM/YYYY, YYYY/MM/DD

PIP LED

Use the PIP LED option to turn the display of the PIP LED on the airway display on or off. When the PIP LED is on, the airway pressure display LED representing the Peak Inspiratory Pressure of the previous breath remains lit during exhalation.

To modify the PIP LED Setting:

- 1) Push the Select button while **PIP LED** is displayed.
- 2) **PIP LED ON** or **PIP LED OFF** is displayed.
- 3) Turn the Set Value knob until the desired setting is displayed.
- 4) Push the Select button.

Options: ON or OFF

Model Number / Serial Number

Use the Model Number / Serial Number option to view the LTV's model or serial number, and to verify LTM Graphics Monitor compatibility.

To view the LTV model number:

- 1) Turn the Set Value knob while in the **VENT OP** menu until **LTV xxxx** is displayed.
 - The model number is displayed as: **LTV xxxx** where **xxxx** is the model of the ventilator.
 - The model number is set when the ventilator is manufactured.
- 2) Push the Control Lock button to exit, or the Select button to display the serial number option.

To view the LTV serial number:

- 1) Push the Select button when the LTV model number (**LTV xxxx**) is displayed.
 - The serial number is displayed on the left side of the display area as: **xxxxxx** where **xxxxxx** is the serial number of the ventilator.
 - The serial number is set when the ventilator is manufactured.
- 2) Push the Control Lock button or the Select button to return to the model number option.

To verify LTM Graphics Monitor Compatibility:

- 1) Push the Select button when the LTV Model Number (**LTV xxxx**) is displayed.
 - The message **LTM** will be displayed on the right side of the display area if the ventilator was originally manufactured or upgraded by Pulmonetic Systems to accommodate the LTM Graphics Monitor.
- 2) Push the Control Lock button or the Select button to return to the model number option.

Valve Home Position

Use the Valve Home Position option to view the home position for the LTV's flow valve. The home position is displayed as: **VHome xxx** where **xxx** is the home position for the valve installed in the ventilator.

The home position is determined by the revision of the flow valve and is set when the ventilator is manufactured or when the flow valve is replaced.

Set Defaults

The SET DEFAULTS option is only displayed and accessed through the Ventilator Checkout menu (**VENT CHECK**) or Ventilator Maintenance menu (**VENT MTNCE**) and is used to reset user settable Controls and Extended Features settings to their factory-set default values. See *Chapter 9 - Ventilator Alarms, DEFAULTS* for factory-set default values.

To enable the Ventilator Checkout menu:

To enable the Ventilator Checkout menu, the patient must be disconnected from the ventilator (ventilate the patient using an alternative method of ventilation), the ventilator must be turned off, and a special power on sequence used to turn it back on. See *Chapter 11 - Ventilator Checkout Tests* for important information and instructions, prior to proceeding.

To set the default values:

- 1) When the **VENT CHECK** menu is displayed, turn the Set Values knob until **VENT OP** is displayed and push Select.
- 2) Turn the Set Values knob until **DEFAULTS** is displayed and push Select. **SET DEFAULTS** will be displayed.
- 3) Push Select while **SET DEFAULTS** is displayed. **DEFAULTS** will be displayed.
 - Except for the Language selected and the Date/Time settings and format, all user settable Controls and Extended Features options are reset to their factory-set default values.
 - A **DEFAULTS** event is recorded in the Event Trace log (see *Appendix E - Event Trace* for additional information) along with the date and time the settings were reset.

To exit the Ventilator Checkout menu and enter normal ventilation mode:

- 1) Turn the Set Values knob through the Ventilator Operations sub-menus until **EXIT** is displayed, and push the Select or Control Lock button. **VENT OP** will be displayed.
- 2) When **VENT OP** is displayed, turn the Set Values knob until **EXIT** is displayed, and push the Select or Control Lock button.
 - POST will be performed, the ventilator will begin ventilation using the factory set default settings and a **DEFAULTS SET** alarm will be generated (see *Chapter 9 - Ventilator Alarms, DEFAULTS SET* for additional information and instructions to reset the **DEFAULTS SET** alarm).

O₂ Cylinder Duration (LTV® 1000 Only)

Use the O₂ Cylinder Duration option to calculate the approximate remaining usable time (in hours and minutes) of an external O₂ cylinder.

- To obtain an accurate duration time estimate, the current cylinder pressure must be entered prior to each calculation.

WARNING

O₂ Cylinder Duration Information - The accuracy of the displayed useable amount of oxygen remaining in an external O₂ cylinder (**O2 DUR hh:mm**) is dependant on the precision of the pressure gauge used on the O₂ cylinder and the accuracy of the information provided by the operator in the **O2 CYL DUR** menu settings. The calculated/displayed useable amount of oxygen information is to be used for reference purposes only.

Ventilation Variables and O₂ Consumption - Variations in the patient's minute ventilation, I:E ratio and/or ventilator setting changes or equipment status (i.e. circuit leaks) affect the consumption rate of oxygen. When warranted by a patients condition, it is recommended that a back-up cylinder or alternative source of oxygen be available at all times.

AVERTISSEMENT

Informations sur la durée d'utilisation restante de la bouteille d'oxygène - La précision de l'affichage de la quantité d'oxygène utilisable restante dans une bouteille d'oxygène externe (**O2 DUR HH:MM**) dépend de la précision de la jauge de pression utilisée sur la bouteille et de l'exactitude des informations fournies par l'opérateur dans les paramètres du menu **DUREE CYL O2**. Les informations calculées et affichées sur la quantité d'oxygène utilisable ne doivent être utilisées qu'à titre indicatif.

Variables de ventilation et consommation d'oxygène — Les variations dans la ventilation par minute du patient et dans le rapport inspiration/expiration, la modification des paramètres ou l'état du matériel (fuite dans le circuit, par exemple) modifient le taux de consommation de l'oxygène. Lorsque la situation du patient le permet, il est recommandé qu'une bouteille d'oxygène de secours ou toute autre source alternative d'oxygène soit disponible en permanence.

To modify the O₂ Cylinder Duration settings:

- 1) Push the Select button while **O2 CYL DUR** is displayed and **CYL TYPE** is displayed.
- 2) Push the Select button while **CYL TYPE** is displayed and **SIZE xxx l** is displayed.
- 3) Turn the Set Value knob until the applicable O₂ cylinder size is displayed (volume in compressed Liters), push the Select button and the cylinder size is set.
 - **Range:** 75 - 9,900 compressed Liters, in increments of 1.
 - This setting is retained by the ventilator (through shut downs and power ups) until re-set by an operator, and used to calculate the remaining oxygen.
 - After changing this, or any ventilation setting, wait approximately 20 seconds before selecting **CALCULATE**, to allow the ventilator to monitor the oxygen flow that will be used in the calculation and display of the remaining usable time of the external O₂ cylinder.

O2 Cylinder Duration (cont)

- 4) Turn the Set Value knob until **CYL PRES** is displayed, push the Select button and **xxx psi** is displayed.
- 5) Turn the Set Value knob until the applicable cylinder pressure is displayed, push the Select button and the cylinder pressure is set.
 - **Range:** 100 - 2300 psi, in increments of 25, **or**
 - **Range:** 5 - 150 bar, in increments of 1 (if the selected language uses the bar unit of measurement)
 - This setting is not retained by the ventilator through shut downs and power ups, will be reset to the factory set default value if the Language setting is changed, and will need to be reviewed/reset by the operator each time the O₂ Cylinder Duration option is used.
 - After changing this, or any ventilation setting, wait approximately 20 seconds before selecting **CALCULATE**, to allow the ventilator to monitor the oxygen flow that will be used in the calculation and display of the remaining usable time of the external O₂ cylinder.
- 6) Turn the Set Value knob until **CALCULATE** is displayed and push the Select button.
 - To obtain an accurate duration time estimate, the current cylinder pressure must be entered prior to each calculation.
 - After changing any ventilation setting, wait approximately 20 seconds before selecting **CALCULATE**, to allow the ventilator to monitor the oxygen flow that will be used in the calculation and display of the remaining usable time of the external O₂ cylinder.
 - When **CALCULATE** is selected, the ventilator uses the current ventilation values and settings to calculate the remaining usable time of the external O₂ cylinder specified and displays **O2 DUR hh:mm** (O₂ duration in hours and minutes) for 60 seconds or until the message is acknowledged by pushing the Select or Control Lock button, or by rotating the Set Value knob on the front panel.
 - Breath to breath variations may cause slightly different results in consecutive calculations.

Exit

To return to the top of the VENT OP menu:

- 1) Push the Select button while **EXIT** is displayed.

Transducer Autozero

Use the Transducer Autozero menu to manually schedule transducer autozeros and to view previous autozero results. Autozeros are automatically scheduled at appropriate intervals during ventilator operation, so manual scheduling of autozeros is not commonly performed, but may occasionally be done.

The menu is set up as follows:

XDCR ZERO

AP xxxx P

FDb xxxx P

FDw xxxx P

FDn xxxx P

Airway Pressure Transducer Autozero

Use this item to view the Airway Pressure Transducer Autozero results and schedule the Airway Pressure Transducer Autozero to be run.

To view the Airway Pressure Transducer Autozero results:

- 1) The previous results, **AP xxxx P**, are displayed. The final P indicates the previous zero results were within the required tolerance and the previous autozero passed. If a final F is displayed, the previous zero results were outside the required tolerance and the autozero failed. An asterisk indicates that an autozero is scheduled for the next breath.
- 2) Turn the Set Value knob to display the **EXIT** option.
- 3) Push the Select button.

To schedule the Airway Pressure Transducer Autozero:

- 1) The previous results, **AP xxxx P**, are displayed.
- 2) Push the Select button. An asterisk appears, the pass / fail indicator is removed from the display and the test is scheduled for the next breath.
- 3) After the autozero is run on the next breath, the new autozero value and the pass / fail indicator are displayed.

If an autozero fails, it will be automatically rescheduled for the next breath.

Bi-directional Flow Transducer Differential Autozero

Use this item to view the Bi-directional Flow Transducer Differential Autozero results and schedule Autozeros to be run.

To view the Bi-directional Flow Transducer Differential Autozero results:

- 1) The previous results, **FDb xxxx P**, are displayed. If the results are displayed as **FDb xxxx -**, the Bi-directional Flow Transducer is not installed on your unit. The final P indicates the previous zero results were within the required tolerance and the previous autozero passed. If a final F is displayed, the previous zero results were outside the required tolerance and the autozero failed. An asterisk indicates that an autozero is scheduled for the next breath.
- 2) Turn the Set Value knob to display the **EXIT** option.
- 3) Push the Select button.

To schedule the Bi-directional Flow Transducer Differential Autozero:

- 1) The previous results, **FDb xxxx P**, are displayed.
- 2) Push the Select button. An asterisk appears, the pass / fail indicator is removed from the display and the autozero test is scheduled for the next breath.
- 3) After the autozero is run on the next breath, the new autozero value and the pass / fail indicator are displayed.

If the autozero fails, it will be automatically rescheduled for the next breath.

Exhalation Flow Transducer Differential Autozero - Narrow

Use this item to view the Exhalation Flow Transducer Differential Autozero – Narrow results and schedule the Exhalation Flow Transducer Differential Autozero - Narrow to be run.

To view the Exhalation Flow Transducer Differential Autozero – Narrow results:

- 1) The previous results, **FDn xxxx P**, are displayed. The final P indicates the previous zero results were within the required tolerance and the previous autozero passed. If a final F is displayed, the previous zero results were outside the required tolerance and the autozero failed. An asterisk indicates that an autozero is scheduled for the next breath.
- 2) Turn the Set Value knob to display the **EXIT** option.
- 3) Push the Select button.

To schedule the Exhalation Flow Transducer Differential Autozero - Narrow:

- 1) The previous results, **FDn xxxx P**, are displayed.
- 2) Push the Select button. An asterisk appears, the pass / fail indicator is removed from the display and the autozero test is scheduled for the next breath.
- 3) After the autozero is run on the next breath, the new autozero value and the pass / fail indicator are displayed.

If the autozero fails, it will be automatically rescheduled for the next breath.

Exhalation Flow Transducer Differential Autozero - Wide

Use this item to view the Exhalation Flow Transducer Differential Autozero - Wide results and schedule the Exhalation Flow Transducer Differential Autozeros - Wide to be run.

To view the Exhalation Flow Transducer Differential Autozero – Wide results:

- 1) The previous results, **FDw xxxx P**, are displayed. The final P indicates the previous zero results were within the required tolerance and the previous autozero passed. If a final F is displayed, the previous zero results were outside the required tolerance and the autozero failed. An asterisk indicates that an autozero is scheduled for the next breath.
- 2) Turn the Set Value knob to display the **EXIT** option.
- 3) Push the Select button.

To schedule the Exhalation Flow Transducer Differential Autozero - Wide:

- 1) The previous results, **FDw xxxx P**, are displayed.
- 2) Push the Select button. An asterisk appears, the pass / fail indicator is removed from the display and the autozero test is scheduled for the next breath.
- 3) After the autozero is run on the next breath, the new autozero value and the pass / fail indicator are displayed.

If the autozero fails, it will be automatically rescheduled for the next breath.

Real Time Transducers

Use the Real Time Transducer data to view the real time activity in the ventilator. The real time transducer menu is set up as follows:

RT XDCR DATA

AP xx.xx cmH_2O
FDb xx.xx cmH_2O
FDw xx.xx cmH_2O
FDn xx.xx cmH_2O
FTw or FTn xx.xx Lpm
FTb x.xx Lpm
LEAK xx.xx Lpm
FVd xx.xx cmH_2O
FV xx.xx Lpm
STEP xxxx
TS xxxx rpm
O2 xx.xx PSI
BV xx.xx VOLTS
EV xx.xx VOLTS
RT EXIT

Each item displays real time activity in the displayed units. For some items, transducer counts can also be displayed. Pushing Select while the item is displayed displays additional transducer data⁵³.

Display	Real Time Data
AP xx.xx cmH_2O	Airway pressure as measured at the patient wye using the high side proximal sense line.
FDb xx.xx cmH_2O	Flow differential pressure as measured at the patient wye using the bi-directional transducer. Differential pressure is measured between the high and low side proximal sense lines.
FDw xx.xx cmH_2O	Flow differential pressure as measured at the patient wye using the wide scale transducer. Differential pressure is measured between the high and low side proximal sense lines.
FDn xx.xx cmH_2O	Flow differential pressure as measured at the patient wye using the narrow scale transducer. Differential pressure is measured between the high and low side proximal sense lines. The narrow scale transducer is only used for differential pressures between -0.35 cmH_2O and 0.35 cmH_2O (approximately -15 Lpm to 15 Lpm).
FTb xx.xx Lpm	Flow in Lpm calculated from the differential pressure measured at the patient wye using the bi-directional transducer. Transducer count display is not available for this item.

⁵³ For more information, see the *LTV® Series ventilator Service Manual*

Display	Real Time Data
LEAK xx.xx Lpm	Leak flow calculated from the differential pressure transducer, measured at the patient wye during exhalation. This value will be approximately 0.0 when the ventilator is autocycling. Eliminate autocycling by turning the sensitivity off before reviewing this measurement.
FTw xx.xx Lpm or FTn xx.xx Lpm	Flow in Lpm calculated from the differential pressure measured at the patient wye. When the value is calculated using the wide scale differential pressure, FTw is displayed. When the value is calculated using the narrow scale differential pressure, FTn is displayed. When Leak Compensation is on, FTw xx.xx and FTn xx.xx Lpm values are offset by the value of LEAK xx.xx Lpm. Transducer count display is not available for this item.
FVd xx.xx ^c_mH₂O	Differential pressure as measured across the flow valve.
FV xx.xx Lpm	Flow valve flow in Lpm calculated from the differential pressure measured across the flow valve. Transducer count display is not available for this item.
STEP xxxx	Commanded flow valve motor step position. Transducer count display is not available for this item.
TS xxxx rpm	The monitored speed of the turbine in rpms.
O2 xx.xx PSI	Oxygen inlet pressure in PSIG as measured at the inlet pressure transducer.
BV xx.xx VOLTS	Internal battery voltage.
EV xx.xx VOLTS	External power voltage.

Chapter 11 - VENTILATOR CHECKOUT TESTS

This chapter details five test procedures accessed through the Vent Check menu and used to verify the proper operation of the LTV[®]. These tests should be performed as shown in the schedule in *Appendix B - Set Up / Maintenance* for periodic maintenance and testing of the ventilator.

The five test procedures are:

Test	Test used to:
Alarm Test	Verify that the audible alarm is working correctly.
Display Test	Verify that the ventilator displays are working correctly.
Control Test	Verify that the buttons and the Set Value knob are working correctly.
Leak Test	Test the patient circuit for leaks.
Vent Inop Alarm Test	Verify that the Inop Alarm is working correctly.

The Vent Check Menu is set up as follows:

VENT CHECK

ALARM
DISPLAY
CONTROL
LEAK
EXIT



WARNING

Ventilator Checkout Tests – Gas is not delivered to the patient during these tests. Disconnect the patient from the ventilator and ventilate using an alternative method before running the Ventilator Checkout tests.

Leak Testing the Patient Breathing Circuit – The patient circuit must be leak tested in **VENT CHECK** mode before connection to the patient. Ventilator Checkout mode should also be used to check for correct operation of the alarms, displays and controls. Harm to the patient or ineffective ventilation may result from failure to leak test the patient breathing circuit before connection to a patient. When using a heated humidifier, include it in the circuit when leak testing.



AVERTISSEMENT

Tests de vérification du ventilateur – Noter que le gaz n'est pas transmis au patient au cours de ces tests. Débrancher le patient du ventilateur et ventiler à l'aide d'une forme de ventilation alternative avant de procéder aux tests de vérification du ventilateur.

Contrôle de l'étanchéité du circuit respiratoire du patient – L'étanchéité du circuit respiratoire du patient (vérification de ventilation) doit être vérifiée en mode **VENT CHECK** avant le raccordement au patient. En outre, on doit utiliser le mode Ventilator Checkout (vérification du ventilateur) afin de s'assurer du fonctionnement adéquat de l'alarme, des affichages et des commandes du ventilateur. Le défaut de vérifier l'étanchéité du circuit respiratoire du patient avant le raccordement à un patient peut être nocif pour le patient ou provoquer une ventilation inefficace. Lorsqu'un humidificateur chauffant est employé, il convient de l'inclure dans le circuit en procédant à la vérification de l'étanchéité.

To enable the Ventilator Checkout menu:

- 1) Disconnect the patient from the ventilator and ventilate the patient using an alternative method.
- 2) Turn the ventilator off.
- 3) Ensure that the AC Adapter is connected to a valid AC power source and verify that the External Power and Charge Status LEDs are illuminated.
- 4) Push and hold the Select button. Continue to hold the Select button and press the On/Standby button. **REMOVE PTNT** should be displayed; if not, power down the ventilator and repeat steps 2 through 4.
- 5) An audible alarm (alternating on/off tone) will sound while **REMOVE PTNT** is displayed.

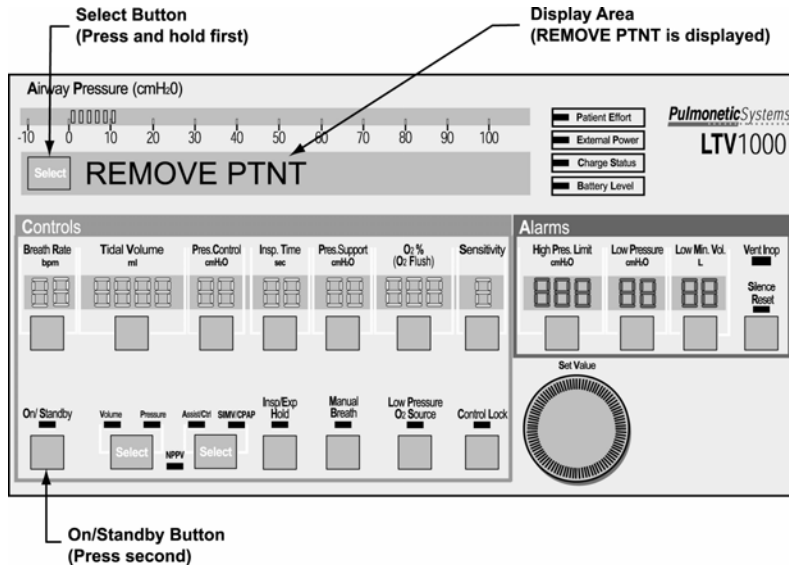

- 6) Clear the alarm by pressing the Silence/Reset button. The audible alarm silences, and the display changes to **VENT CHECK**.

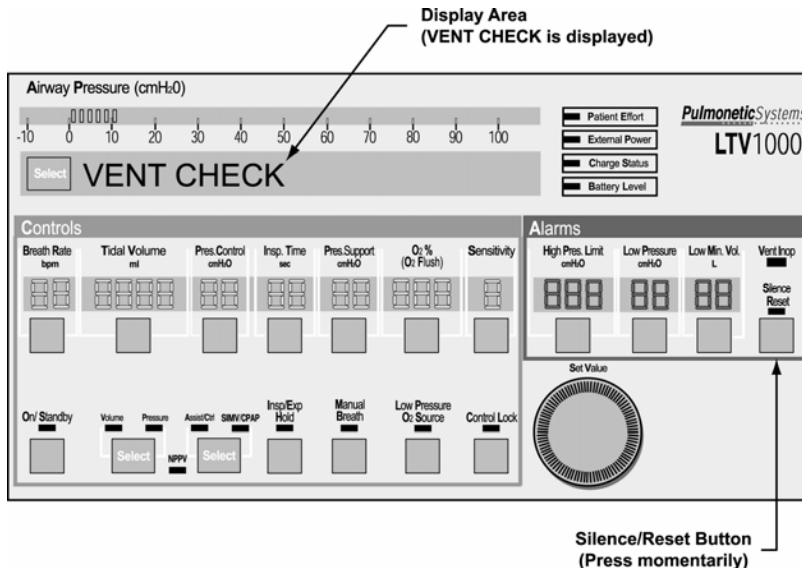

- 7) Push the Select button. The first Ventilator Checkout Test, **ALARM**, is displayed.

Alarm Test

Use the Alarm Test to verify that the audible alarm is working correctly.

To run the Alarm Test:

- 1) Push the Select button while **ALARM** is displayed.
- 2) Verify that the audible alarm is sounded.
 - If a Patient Assist Call System or Remote Alarm is connected via the ventilator's Patient Assist Port, verify the device also activates (audible/visual), as specified by its manufacturer.
- 3) When the alarm has sounded for at least 2 seconds, push the Select button again.
 - The audible alarm is silenced and the next menu item is displayed.
- 4) For ventilators with an audio sound symbol (🔊) on the back panel label, verify a confirming audible chirp occurs after the alarm is silenced.

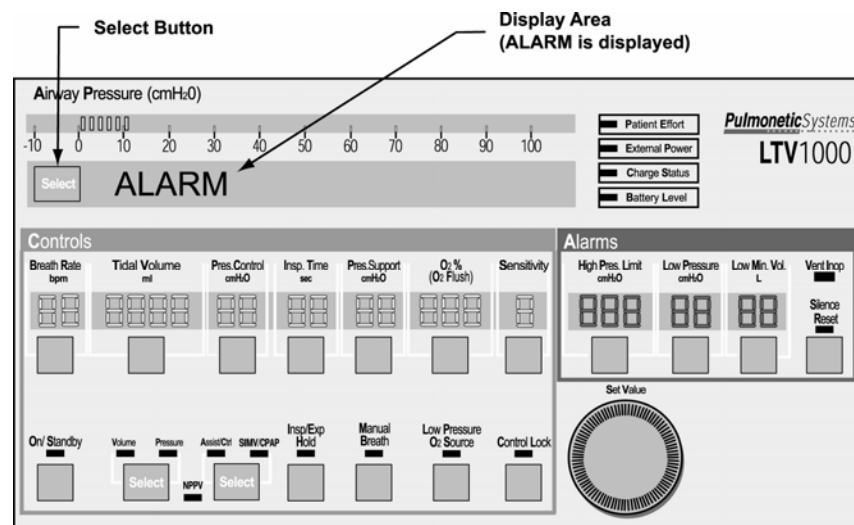

If the Alarm Test fails, see *Chapter 15 - Troubleshooting* for more information.

Display Test

Use the Display Test to verify that the ventilator displays are working correctly.

To run the Display Test:

- 1) Push the Select button while **DISPLAY** is displayed.
- 2) All segments of the 7-segment control displays, all dots of the dot-matrix window displays and all LEDs are illuminated.
 - Although the LTV[®] 1000 front panel is shown below, the test is applicable to all LTV[®] Series ventilators.

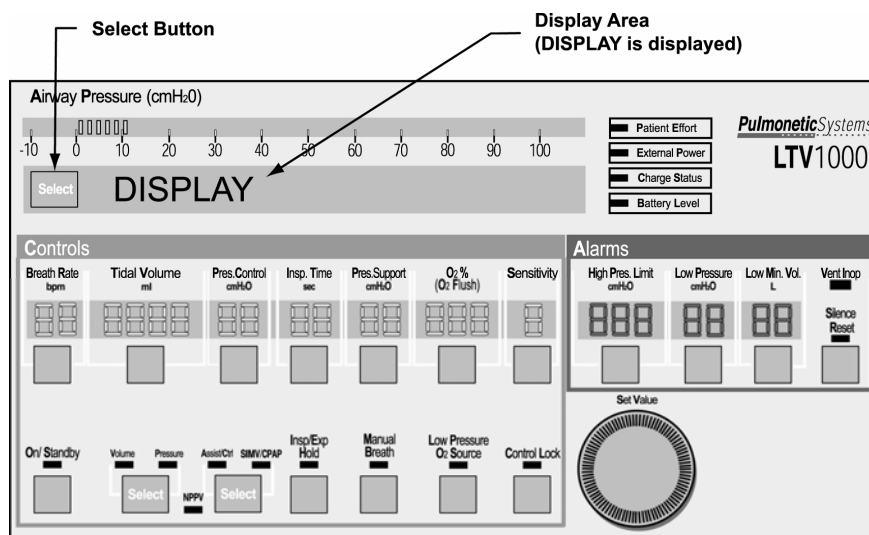

NOTE

The display states for the **External Power**, **Vent Inop**, and **Charge Status** LEDs are not tested in the Display Test.

- The **External Power** and **Charge Status** LEDs are tested and verified when the AC adapter is connected to the ventilator (see page 11-2).
- The **Vent Inop** LED is tested and verified during the Vent Inop Alarm Test (see page 11-11).

REMARQUE

Ce test d'affichage ne comprend pas l'état d'affichage des DEL **External Power**, **Vent Inop**, et **Charge Status**.

- Les DEL **External Power** et **Charge Status** sont testés et vérifiés lorsqu'on branche l'adaptateur CA au ventilateur (voir page 11-2).
- Le DEL **Vent Inop** est testé et vérifié en même temps que l'avertisseur du Vent Inop (voir page 11-11).

Display Test (cont)

Verify displays are illuminated in the following colors:

Display	Color	Display	Color
Airway Pressure Display	Green	Pressure Mode LED ⁵⁴	Green
Display Window	Red	Assist/Control Mode LED	Green
Breath Rate	Green	SIMV/CPAP Mode LED	Green
Tidal Volume	Green	NPPV Mode LED	Green
Pressure Control ⁵⁴	Green	Inspiratory / Expiratory ⁵⁵	Green
Inspiratory Time	Green	Manual Breath LED	Green
Pressure Support	Green	Low Pressure O ₂ Source LED ⁵⁵	Green
O ₂ % (O ₂ Flush) ⁵⁵	Green	Control Lock LED	Green
Sensitivity	Green	Patient Effort LED	Green
High Pressure Limit Alarm	Red	External Power LED	Not tested
Low Pressure Alarm	Red	Charge Status LED	Not tested
Low Minute Volume Alarm	Red	Battery Level LED	Amber
On/Standby LED	Green	Vent Inop LED	Not tested
Volume Mode LED ⁵⁴	Green	Silence Reset LED	Red

3) To end the display test, push the Select button again and the next menu item is displayed.

If the Display Test fails, see *Chapter 15 - Troubleshooting* for more information.

⁵⁴ Not applicable to the LTV[®] 900.

⁵⁵ Not applicable to the LTV[®] 900 and 950.

Control Test

Use the Control Test to verify that the ventilator buttons and the Set Values knob are working correctly.

To run the Control Test:

- 1) Push the Select button while **CONTROL** is displayed.

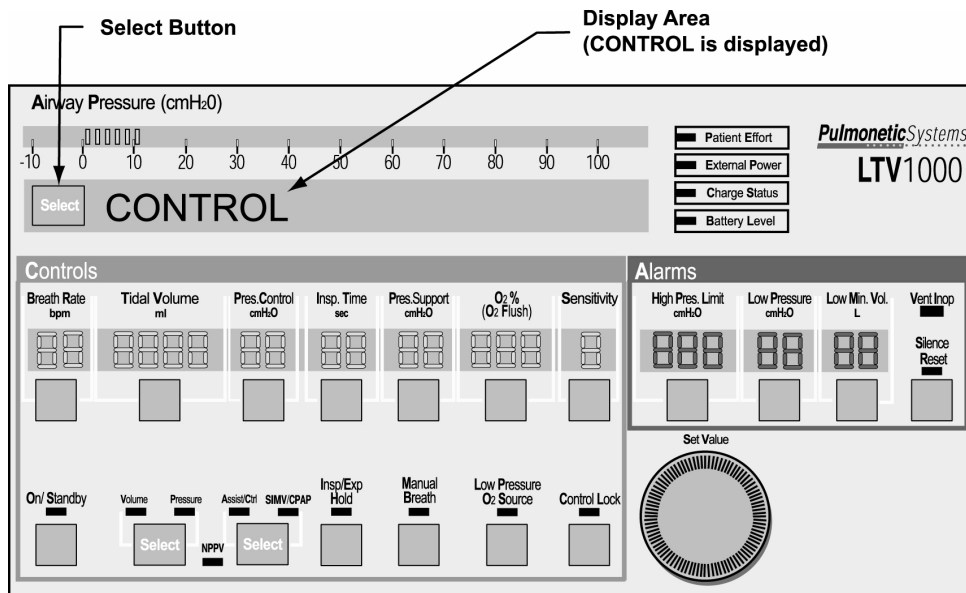

- 2) **SELECT** is displayed in the display window.

- Although the LTV[®] 1000 front panel is shown below, the test is applicable to all LTV[®] Series ventilators.

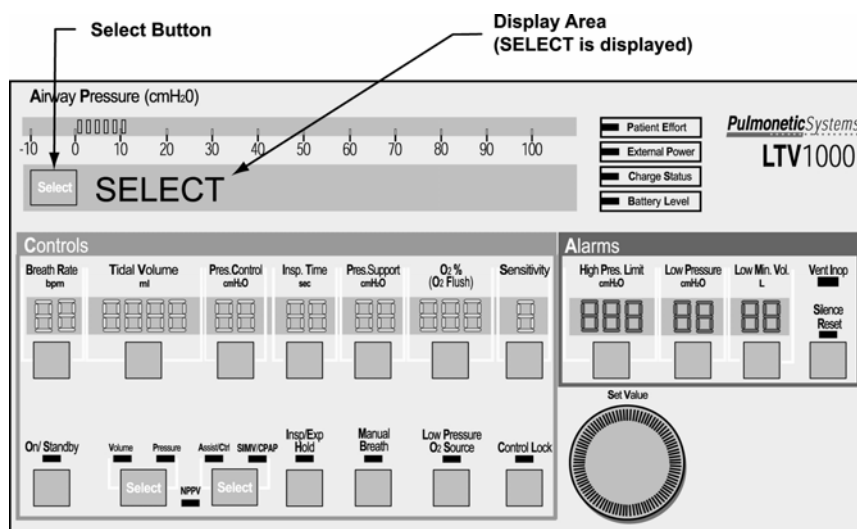

Control Test (cont)

- 3) Test each control by pressing each button, one at a time. When pressed, verify that the name of the button pressed is displayed in the display window. Control names are as shown in the table below.

Control	Display
Display Select	SELECT
Breath Rate	BREATH RATE
Tidal Volume	TIDAL VOLUME
Pressure Control ⁵⁶	PRES CONTROL
Inspiratory Time	INSP TIME
Pressure Support	PRES SUPPORT
O ₂ % (O ₂ Flush) ⁵⁷	O2%
Sensitivity	SENSITIVITY
High Pressure Alarm	HIGH PRES
Low Peak Pressure	LOW PRES
Low Minute Volume	LOW MIN VOL
Silence / Reset	SILENCE
On/Standby	ON / STNDBY
Volume & Pressure ⁵⁶	MODE VOL/PRS
Assist/Control & SIMV/CPAP	MODE A/C S/C
Inspiratory / Expiratory Hold ⁵⁷	IE HOLD
Manual Breath	MANUAL BRTH
Low Pressure O ₂ Source ⁵⁷	LOW PRES O2
Control Lock	CONTROL LOCK
Set Value Knob rotate Left	ROTATE LEFT
Set Value Knob rotate Right	ROTATE RIGHT

- 4) Test the Set Value knob by turning it clockwise and counterclockwise. Verify that the direction of rotation is displayed in the display window.
- 5) To exit the control test, push the Select button again and the next menu item is displayed.

If the Control Test fails, see *Chapter 15 - Troubleshooting* for more information.

⁵⁶ Not applicable to LTV® 900.

⁵⁷ Not applicable to LTV® 900 and 950.

Leak Test

Use the Leak Test to test the patient circuit for leaks.

To run the Leak Test:

- 1) Attach all patient circuit accessories (such as water traps, heated circuits and humidifiers) to the patient circuit.
- 2) Connect the patient circuit to the LTV[®] Series ventilator.
- 3) With a clean, gloved hand or 4"X4" gauze pad, occlude the proximal end of the patient circuit.
- 4) Push the Select button while **LEAK** is displayed.

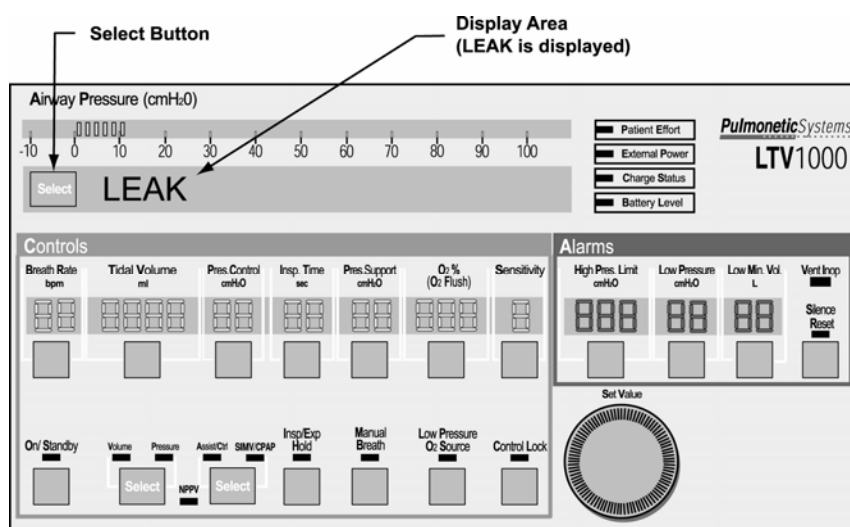

NOTE

The Leak Test cannot be run until the ventilator has been running for 60 seconds. If you attempt to run the leak test before the warm-up period has completed, a **WAITING** message will be displayed. When the warm-up period is complete, the Leak Test menu item is redisplayed.

REMARQUE

Le test de fuites ne peut s'exécuter tant que le ventilateur n'a pas fonctionné durant 60 secondes. Si vous tentez d'exécuter un test de fuites avant que la période de réchauffement ne soit complétée, un message «**PATIENTEZ** » sera affiché. Lorsque la période de réchauffement est complétée, les éléments du menu Test de fuites sont de nouveau affichés.

Leak Test (cont)

- 5) To perform the Leak Test, the ventilator does the following:
 - a) Closes the exhalation valve and sets the flow valve to a near-closed state. The display briefly shows **HOMING VALVE**.
 - b) Elevates the turbine motor speed. The display shows **SET TURBINE**. If the display shows **LEAK --- FAIL**, see *Chapter 15 - Troubleshooting* for more information.
 - c) Elevates the circuit pressure. The display shows **PRES xx.x cmH₂O** where **xx.x** is the real-time airway pressure.
 - d) Sets the flow valve to a near closed position. The display shows **FLOW xx.x Lpm** where **xx.x** is the flow through the flow valve.
 - e) After several seconds, the display shows **LEAK xx.x PASS** or **LEAK xx.x FAIL** indicating the Leak Test results. The Leak Test will fail if the flow through the flow valve is greater than 1 Lpm.
- 6) To exit the Leak Test, push the Select button again and the next menu item is displayed.

If the ventilator fails the Leak Test, see *Chapter 15 - Troubleshooting* for more information.

Vent Inop Alarm Test

Use the Vent Inop Alarm Test to verify that the Inop Alarm is working correctly.

To run the Vent Inop Alarm Test:

- 1) To run the Vent Inop Alarm Test, the ventilator must be on (running) for at least 60 seconds and the Ventilator Checkout menu must be enabled.
 - When the Ventilator Checkout menu is enabled, **VENT CHECK, ALARM, DISPLAY, CONTROL, LEAK, or EXIT** is displayed in the ventilator display area.
- 2) Turn the ventilator off by pressing and holding the On/Standby button for a minimum of 3 seconds. **DO NOT** push the Silence/Reset button.

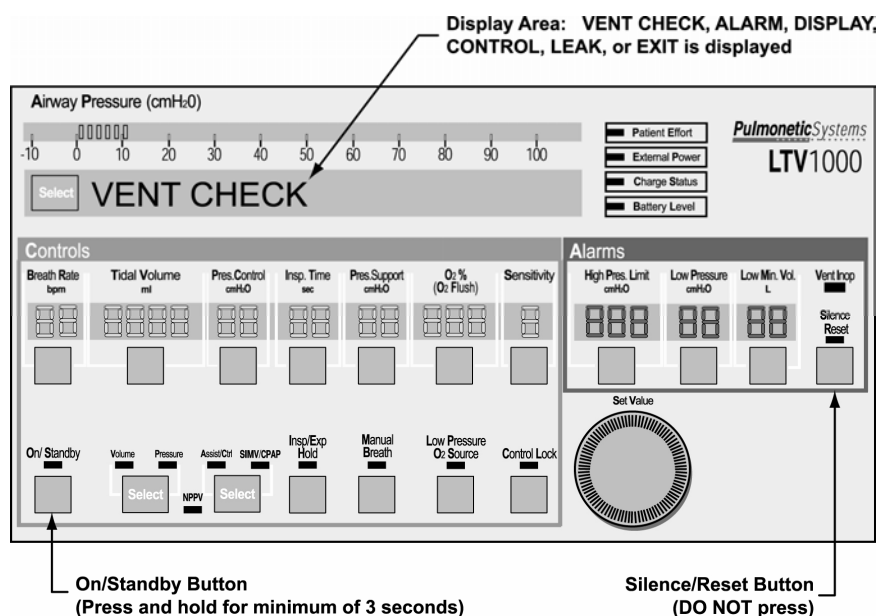

- 3) Observe the ventilator for 15 seconds.
 - Listen for the alarm tone
 - Watch the Vent Inop LED

Vent Inop Alarm Test (cont)

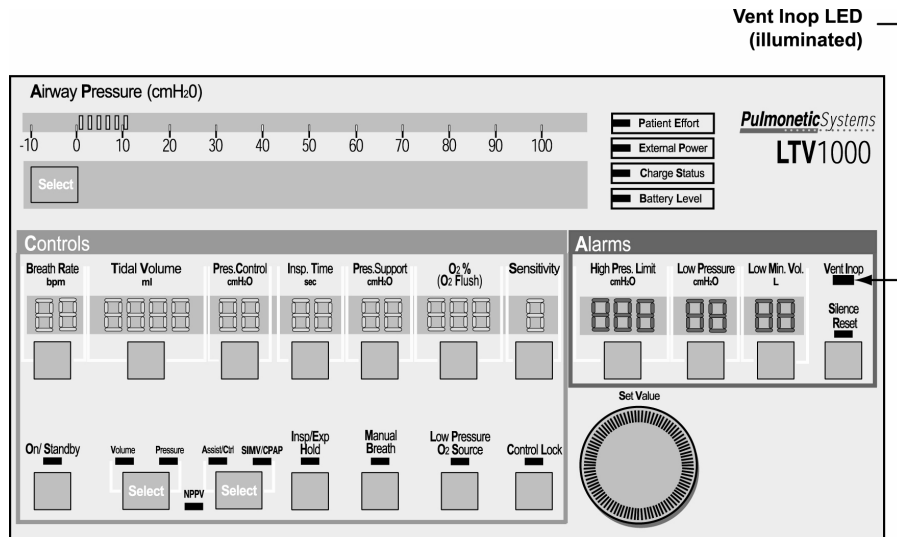

- 4) For all ventilators, verify that both of the following conditions existed;
 - The alarm tone sounded continuously for the full 15-second duration.
 - The Vent Inop LED illuminated continuously for the full 15-second duration.
- 5) If a Patient Assist Call System or Remote Alarm is connected via the ventilator's Patient Assist Port, verify the device also activates (audible/visual), as specified by its manufacturer.
- 6) Silence the alarm by pressing the Silence/Reset button.
- 7) Verify the following;
 - A confirming audible chirp occurred after the alarm was silenced.

If the Inop Alarm fails the test, discontinue use of the ventilator and immediately contact a certified Pulmonetic Systems' service technician.

Exit

To exit the vent check mode and return to normal ventilation mode at any point proceed as follows:

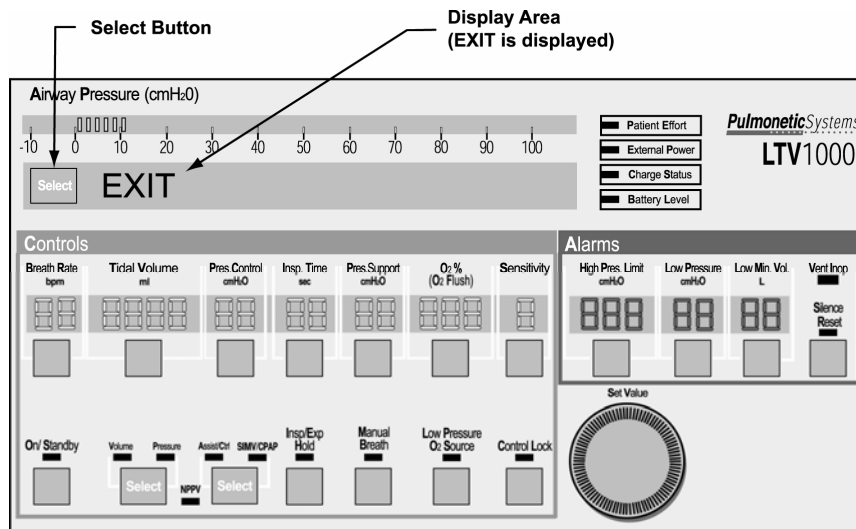

Enter normal ventilation mode:

- 1) Turn the Set Value Knob to scroll through the main menu entries (**VENT OPS**, **ALARM OPS**, **VENT CHECK**, etc.) until **EXIT** is displayed.
- 2) Push the Select button while **EXIT** is displayed.
- 3) Alternatively, push the Control Lock button until normal ventilation mode is restored.

POST will be performed and the ventilator will begin ventilation using the previously stored settings.

Chapter 12 - OPERATING PROCEDURE

This section describes how to turn the LTV[®] Series ventilator on and off, and how to set up the ventilation modes.

To Turn the Ventilator On

- 1) Connect the unit to an external source of power. The AC power adapter may be used or the ventilator may be connected to an external battery.
 - The **External Power** LED is lit to indicate the external power source voltage level.
 - The ventilator begins charging the internal battery from the external source.
 - The **Charge Status** LED is lit to indicate the charge progress.

NOTE

In the absence of an external power source, the ventilator automatically begins operation using the internal battery.

Do not operate the LTV[®] exclusively on the internal battery as a standard operating practice. The internal battery should be used for **emergency situations only** or for short periods while switching between external power supply connections.

REMARQUE

S'il n'y a pas de source d'alimentation externe, le ventilateur s'alimente automatiquement de la pile interne.

Ne pas utiliser le LTV[®] exclusivement avec la batterie interne en tant que procédure d'exploitation normale. La batterie interne doit être réservée aux **situations d'urgence seulement** ou pour de courtes périodes de temps pendant le transfert entre des sources d'alimentation externes.

- 2) Push the On / Standby button and the ventilator will commence operation:
 - The **On / Standby** LED is lit.
 - The Power On Self Tests⁵⁸ (POST) are performed:
 - The front panel displays light up.
 - The audible alarm activates for 1 second (to be verified by operator⁵⁹).
 - A confirming audible chirp sounds⁵⁹ (to be verified by operator⁵⁹).
 - POST messages (CPU, SRAM, INT VECTOR, ROM CRC and EEPROM) are flashed in the message window.

⁵⁸ Power On Self Tests - A set of self-tests the ventilator performs when turned on to verify the operational integrity of the Processor, Displays, Audible Alarm, Confirming Audible Chirp⁵⁹, SRAM, Program Memory and EEPROM (some tests require operator visual and/or audible verification).

⁵⁹ Only on ventilators with an audio sound symbol (🔊) on the back panel label.

To Turn the Ventilator On (cont.)

If the Power On Self Tests are passed successfully, the ventilator starts operation using the stored control settings, with the following exceptions;

- To prevent nuisance alarms, the **LOW MIN VOL** alarm (Low Minute Volume) is suspended for the first 20 seconds and the **HIGH f** alarm (High Breath Rate) is suspended for the first 60 seconds of operation.

If the Power On Self Tests fail, the mode of failure (**CPU, SRAM, INT VECTOR, ROM CRC** or **EEPROM**) is displayed in the message window and an audible alarm sounds continuously.

- Turn the ventilator off by pushing the On / Standby button.
- Silence the alarm by pushing the Silence / Reset button.
- Discontinue use of the ventilator and immediately contact a certified Pulmonetic Systems' service technician or Pulmonetic Systems, Inc.

Before Connecting the Ventilator to a Patient

Perform the following steps before connecting the ventilator to a patient:

- 1) If this is the initial use of the ventilator, follow the checkout procedures in *Appendix C - Installation and Checkout* before proceeding.
- 2) If desired, you may connect the ventilator to a **Patient Assist Call system**. See *Appendix C - Installation and Checkout* for details.
- 3) If required, connect a low or high pressure **oxygen source** to the ventilator. If you connect a low pressure oxygen source, make sure to select the Low Pressure O₂ Source option on the front panel. See *Appendix C - Installation and Checkout* for connection and setup details.

WARNING

Inspired Oxygen (FIO₂) Concentration – If the patient has a variable respiratory rate, his/her minute ventilation will fluctuate. If exact concentrations of inspired oxygen (FIO₂) are required to be delivered to the patient, it is recommended that an accurate oxygen analyzer with alarms be used.

AVERTISSEMENT

Concentration d'oxygène inspiré (FIO₂) – Si la fréquence respiratoire du patient est variable, sa ventilation-minute va fluctuer. Lorsqu'une concentration exacte d'oxygène inspiré (FIO₂) est nécessaire pour une transmission au patient, il est recommandé d'utiliser un analyseur de niveau d'oxygène précis, comportant des alarmes.

- 4) Connect the **Patient Circuit**.⁶⁰ To keep moisture out of the sense lines attached at the patient wye, be sure to connect the exhalation valve and circuit to the wye so the proximal sense lines are oriented up (see below). Connect a test lung to the circuit.

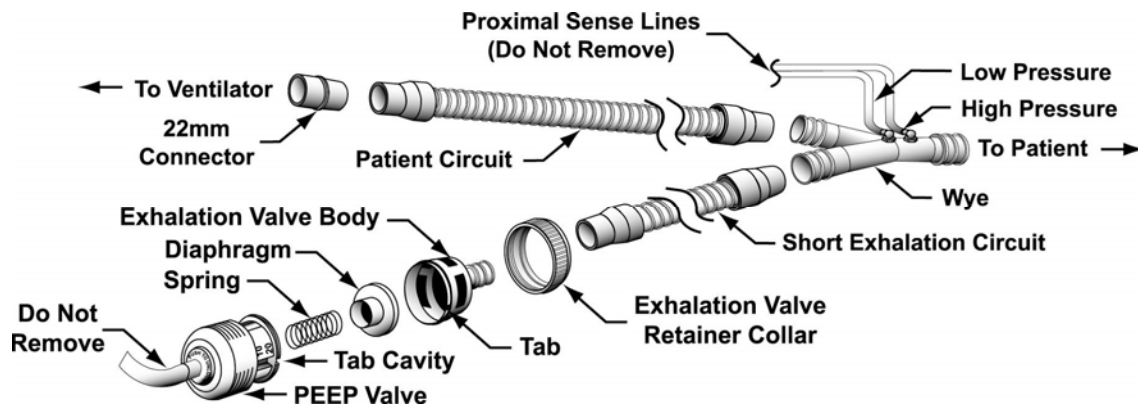

- 5) Set any desired extended features options. For a detailed list of extended features see *Chapter 10 – Extended Features*.
- 6) Select the ventilation mode and all controls, including PEEP, to prescribed values. Detailed procedures for setting each mode are included later in this chapter.

WARNING

Accuracy of PEEP setting - Variations in the patient's breathing pattern or leaks in the patient circuit (including leaks around the tracheostomy tube cuff) can affect PEEP. PSI recommends that the clinician set the PEEP to the prescribed level on a test lung while observing the PEEP value in the LTV display window. The clinician should also periodically monitor the PEEP value in the LTV display window. Using an inaccurate PEEP setting due to a patient leak can result in less than prescribed PEEP or undesirable increases in patient circuit pressure when the patient circuit leak changes.

AVERTISSEMENT

Exactitude du paramètre PEP – Les écarts dans le mode de respiration du patient et/ou les fuites du circuit du patient (y compris les fuites autour du ballonnet pour canule de trachéostomie) peuvent affecter le PEP. Des études et investigations préliminaires recommandent que le clinicien définisse le PEP au niveau prescrit sur un poumon d'essai tout en observant la valeur PEP de l'écran graphique LTV. Le clinicien doit par ailleurs surveiller de façon périodique la valeur PEP de l'écran graphique LTV. L'utilisation d'un paramètre PEP inapproprié en raison d'une fuite de patient peut potentiellement résulter en un paramètre inférieur au paramètre PEP prescrit ou en une augmentation indésirable de la pression du circuit du patient lorsque la fuite du circuit du patient change.

⁶⁰ The LTV® Patient Circuit complies with ASTM Specification F 1246.

Procedure for Control Mode Set Up

Set any desired Extended Features options and:

- 1) Push the mode Select button twice to toggle the modes between **Assist / Control** and **SIMV / CPAP**. Select the **Assist / Control** mode.
- 2) Push the mode Select button twice to toggle between Volume and Pressure ventilation. Select **Volume** or **Pressure**, as desired. (not available on LTV[®] 900)
- 3) Establish the Breath Rate.
- 4) If Volume ventilation is selected, establish the Tidal Volume. The calculated peak flow **Vcalc** is displayed in the window while Tidal Volume is being changed.
- 5) If Pressure ventilation is selected, establish the Pressure Control (Not available on LTV[®] 900).
- 6) Establish the Inspiratory Time. The calculated peak flow **Vcalc** is displayed in the window while Inspiratory Time is being changed. **Vcalc** only applies to volume ventilation.
- 7) Set the desired percentage of oxygen to be delivered by the ventilator (LTV[®] 1000 only).
- 8) Set the Sensitivity to dashes “- -”.
- 9) Set the High Pressure Limit alarm.
- 10) Set the Low Pressure alarm.
- 11) Set the Low Minute Volume alarm.
- 12) Adjust the PEEP valve to set the PEEP control (Ref. page 6-21).

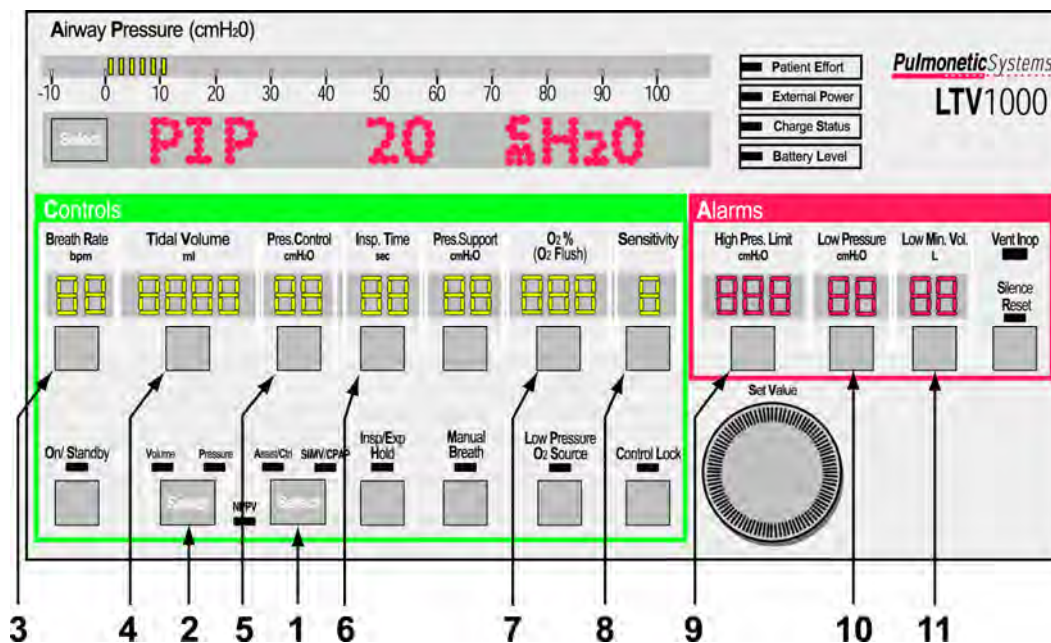

Procedure for Assist / Control Mode Set Up

Set any desired Extended Features options and:

- 1) Push the mode Select button twice to toggle the modes between **Assist / Control** and **SIMV / CPAP**. Select the **Assist / Control** mode.
- 2) Push the mode Select button twice to toggle between Volume and Pressure ventilation. Select **Volume** or **Pressure**, as desired. (not available on LTV[®] 900)
- 3) Establish the Breath Rate.
- 4) If Volume ventilation is selected, establish the Tidal Volume. The calculated peak flow **Vcalc** is displayed in the window while Tidal Volume is being changed.
- 5) If Pressure ventilation is selected, establish the Pressure Control.
- 6) Establish the Inspiratory Time. The calculated peak flow **Vcalc** is displayed in the window while Inspiratory Time is being changed. **Vcalc** only applies to volume ventilation.
- 7) Set the desired percentage of oxygen to be delivered by the ventilator (LTV[®] 1000 only).
- 8) Set the Sensitivity to a setting from 1 to 9.
- 9) Set the High Pressure Limit alarm.
- 10) Set the Low Pressure alarm.
- 11) Set the Low Minute Volume alarm.
- 12) Adjust the PEEP valve to set the PEEP control (Ref. page 6-21).

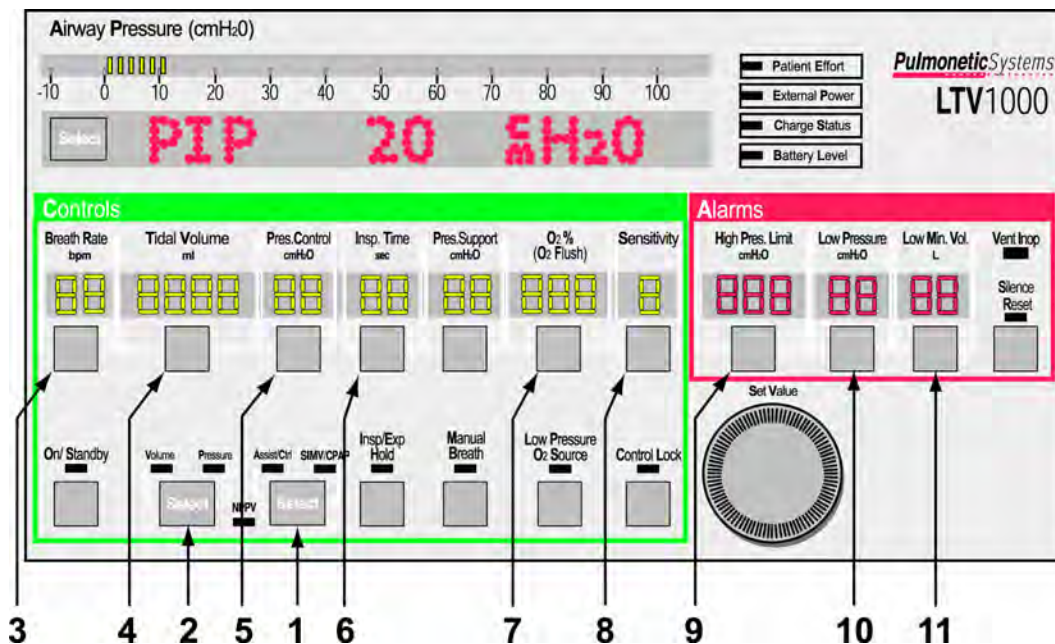

Procedure for SIMV Mode Set Up

Set any desired Extended Features options and:

- 1) Push the mode Select button twice to toggle the modes between **Assist / Control** and **SIMV / CPAP**. Select the **SIMV / CPAP** mode.
- 2) Push the mode Select button twice to toggle between Volume and Pressure ventilation. Select **Volume** or **Pressure**, as desired. (not available on LTV[®] 900)
- 3) Establish the Breath Rate.
- 4) If Volume ventilation is selected, establish the Tidal Volume. The calculated peak flow **Vcalc** is displayed in the window while Tidal Volume is being changed.
- 5) If Pressure ventilation is selected, establish the Pressure Control.
- 6) Establish the Inspiratory Time. The calculated peak flow **Vcalc** is displayed in the window while Inspiratory Time is being changed. **Vcalc** only applies to volume ventilation.
- 7) Set the Pressure Support, if desired.
- 8) Set the desired percentage of oxygen to be delivered by the ventilator (LTV[®] 1000 only).
- 9) Set the Sensitivity to a setting from 1 to 9.
- 10) Set the High Pressure Limit alarm.
- 11) Set the Low Pressure alarm.
- 12) Set the Low Minute Volume alarm.
- 13) Adjust the PEEP valve to set the PEEP control (Ref. page 6-21).

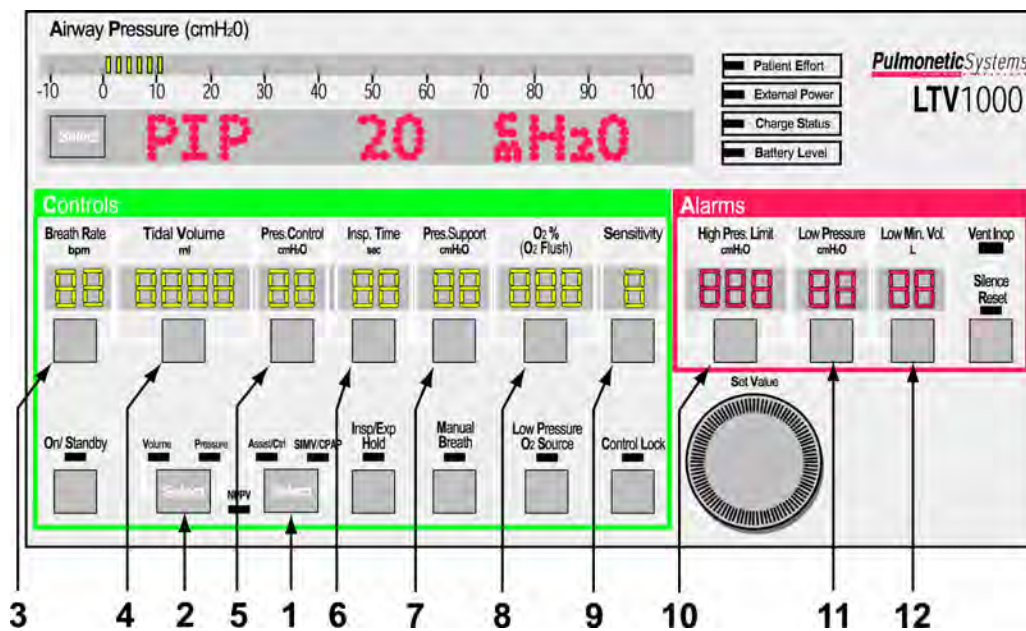

Procedure for CPAP Mode Set Up

Set any desired Extended Features options and:

- 1) Push the mode Select button twice to toggle the modes between **Assist / Control** and **SIMV / CPAP**. Select the **SIMV / CPAP** mode.
- 2) Push the mode Select button twice to toggle between Volume and Pressure ventilation for apnea backup. Select **Volume or Pressure**, as ordered (not available on LTV[®] 900).
- 3) Establish the Breath Rate to dashes “- -”.
- 4) If Volume ventilation is selected, establish the Tidal Volume for apnea backup. The calculated peak flow **Vcalc** is displayed in the window while Tidal Volume is being changed.
- 5) If Pressure ventilation is selected, establish the Pressure Control for apnea backup.
- 6) Establish the Inspiratory Time for apnea backup. The calculated peak flow **Vcalc** is displayed in the window while Inspiratory Time is being changed. **Vcalc** only applies to volume ventilation.
- 7) Set the Pressure Support, if desired.
- 8) Set the desired percentage of oxygen to be delivered by the ventilator (LTV[®] 1000 only).
- 9) Set the Sensitivity to a setting from 1 to 9.
- 10) Set the High Pressure Limit alarm.
- 11) Set the Low Pressure alarm for apnea backup.
- 12) Set the Low Minute Volume alarm.
- 13) Adjust the PEEP valve to set the PEEP control (Ref. page 6-21).

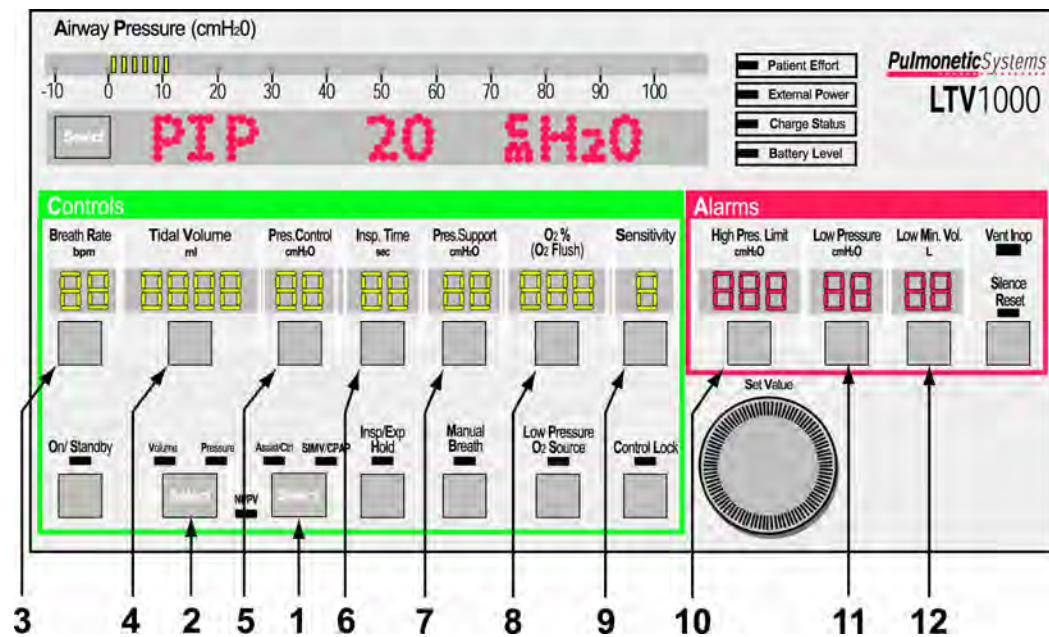

Procedure for NPPV Mode Set Up

Set any desired Extended Features options and:

- 1) Establish the ventilator controls for **Control, Assist / Control, SIMV** or **CPAP** mode as described in the preceding section.
- 2) Establish the ventilator controls for **Volume** or **Pressure** ventilation as described in the preceding section.
- 3) Set the desired percentage of oxygen to be delivered by the ventilator (LTV[®] 1000 only).
- 4) Establish the High Pressure Limit alarm.
- 5) Enter Extended Features by pushing and holding the Monitor Select key for 3 seconds.
- 6) Turn the Set Values knob until **VENT OP** is displayed.
- 7) Push Select.
- 8) Turn the Set Values knob until **NPPV** Mode is displayed.
- 9) Push Select.
- 10) Turn the Set Values knob until **NPPV ON** is displayed.
- 11) The **NPPV** LED will be illuminated.
- 12) Push Select.
- 13) Exit the Extended Features menus by turning the Set Values knob until Exit is displayed and pushing Select until monitored data is displayed in the window.

WARNING

NPPV Mode - NPPV⁶¹ is not a life support mode and is not suitable for patients that require life support ventilation. NPPV Mode should only be used for supplemental ventilation of non-life support patients.

NPPV Mode alarms - When operating in NPPV⁶¹ mode, many of the standard alarms are disabled. This may result in reduced ventilation accuracy should a problem occur. Carefully read *Chapter 4 - Ventilation Modes*, NPPV, before selecting this mode of operation.

AVERTISSEMENT

Mode NPPV – Le mode NPPV n'est pas un mode de maintien des fonctions vitales continu et il n'est pas approprié pour les patients qui ont besoin d'une ventilation continue pour le maintien des fonctions vitales. Le mode NPPV ne doit être utilisé que comme ventilation supplémentaire pour les patients qui ne nécessitent pas de maintien des fonctions vitales.

Mode NPPV, alarmes – Lorsque l'appareil fonctionne en mode NPPV, bon nombre des alarmes standards sont désactivées. Par conséquent, si un problème survient, la précision de la ventilation pourrait diminuer. Assurez-vous de lire attentivement le chapitre 4 – Types de respiration et modes de ventilation, mode NPPV avant de choisir ce mode de fonctionnement.

⁶¹ Non-Invasive Positive Pressure Ventilation.

To Turn the Ventilator Off

- 1) Disconnect the ventilator from the patient.
- 2) Push and hold the On / Standby button for 3 seconds. The ventilator ceases operating, the audible alarm sounds continuously and the **Vent Inop** LED is lit.
- 3) Stop the audible alarm from sounding by pushing the Silence / Reset button.
 - Verify a confirming audible chirp⁶² sounds immediately after the alarm is silenced⁶³
- 4) The ventilator continues to charge the internal battery as long as it is connected to an external power source.

NOTE

The **VENT INOP** LED will remain lit for a minimum of 5 minutes and does not affect battery life.

REMARQUE

La DEL **VENT INOP** restera allumée durant au moins 5 minutes et n'affecte en rien la durée de vie de la batterie.

⁶² Only on ventilators with an audio sound symbol (🎵) on the back panel label.

⁶³ The audible Chirp occurs after the Inop Alarm sounds for longer than 0.8 seconds and is then silenced.

LTV® Ventilator Settings Checklist

The LTV® Ventilator Settings Checklist may be used by caregivers as a reminder that all appropriate controls on the LTV® were properly set, adjusted and/or recorded.

Patient Name:		Ordered By:		Date:	
Controls: (Fill in (x.x), or Confirm (X))				Monthly Check-up	
Volume Mode:	- or -	Pressure Mode	By:	Date:	
Assist Control:	- or -	SIMV	By:	Date:	
Breath Rate:		bpm	By:	Date:	
Tidal Volume:		ml	By:	Date:	
Pressure Control:		cmH ₂ O	By:	Date:	
Inspiratory Time:		Seconds	By:	Date:	
Pressure Support:		cmH ₂ O	By:	Date:	
High Pressure O ₂ %: (LTV® 1000)		FIO ₂	By:	Date:	
Low Pressure O ₂ %: (LTV® 1000/950/900)		Lpm	By:	Date:	
Sensitivity:		Lpm	By:	Date:	
Alarms: (Fill in (x.x), or Confirm (X))				Monthly Check-up	
High Pressure Limit:		cmH ₂ O	By:	Date:	
Low Pressure Limit:		cmH ₂ O	By:	Date:	
Low Minute Volume:		Liters	By:	Date:	
Extended Features-Alarms: (Fill in (x.x), or Confirm (X))				Monthly Check-up	
Apnea Interval:		Seconds	By:	Date:	
High f	HIGH f OFF	- or -	bpm	By:	Date:
High PEEP	HI PEEP OFF	- or -	cmH ₂ O	By:	Date:
High Pressure Alarm Delay:	YES	- or -	NO	By:	Date:
LPP Alarm:	All Breaths	- or -	VC/PC Only	By:	Date:
Extended Features-Ventilator: (Fill in (x.x), or Confirm (X))				Monthly Check-up	
Rise Time Profile:		(1 to 9)	By:	Date:	
Flow Termination:		10-40% of Peak Flow	By:	Date:	
Pressure Support Time Termination:		Seconds	By:	Date:	
Pressure Control Flow Termination:	YES	- or -	NO	By:	Date:
Leak Compensation:	ON	- or -	OFF	By:	Date:
NPPV Mode: (ON means no audible Low Pressure or LMV alarms)	ON	- or -	OFF	By:	Date:

Chapter 13 - CLEANING, DISINFECTING AND STERILIZING

Cleaning the Ventilator

All ventilator external surfaces should be cleaned before and after each patient use, and as may be required.

To clean the ventilator:

- 1) Wipe the exterior surfaces of the ventilator with a clean, damp cloth. The use of an anti-bacterial cleaning solution is recommended. Be sure to wipe away any residual cleaner.

CAUTION

Ventilator Sterilization – To avoid irreparable damage to the LTV® Series ventilator, do not attempt to sterilize it.

Cleaning Agents – To avoid damaging the ventilator's plastic components and front panel, do not use cleaning agents containing ammonium chloride, other chloride compounds, more than 2% glutaraldehyde, phenols, or abrasive cleaners.

Ventilator Immersion - Do not immerse the ventilator in liquids.

Exhalation Valve Cleaning - Do not pour or spray liquid cleaners into the exhalation valve.

Front Panel Cleaning – Do not pour or spray liquid cleaners onto the front panel.

ATTENTION

Stérilisation du ventilateur - Afin d'éviter des dommages irréparables au ventilateur de la série LTV®, ne tentez pas de stériliser ce dernier.

Produits de nettoyage - Afin d'éviter d'endommager les composants plastiques et le panneau frontal du ventilateur, n'utilisez pas des produits de nettoyage contenant : chlorure d'ammonium, composés de chlorure, plus de 2% de glutaraldéhyde, ou phénol.

Immersion du ventilateur - Ne pas immerger le ventilateur dans des liquides, incluant les produits stérilisants.

Nettoyage de la soupape d'expiration - Ne pas asperger une solution nettoyante dans la soupape d'expiration.

Nettoyage du panneau frontal - Ne pas asperger des solutions nettoyantes ou les laisser s'écouler sur le panneau frontal.

Cleaning or replacing the Fan Filter

To clean the fan filter:

- 1) Using a small screwdriver, detach the fan filter grill from its housing.
- 2) Remove the fan filter by squeezing the foam filter gently with your fingers and pulling it out.

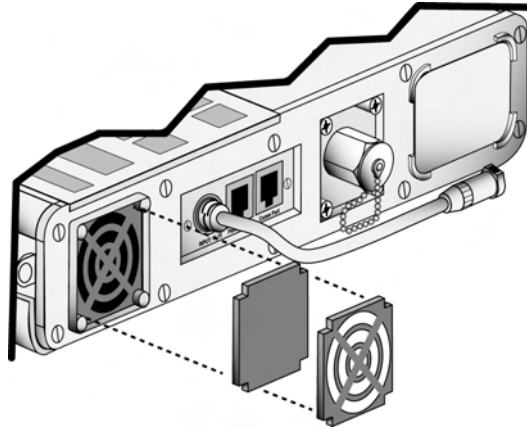

NOTE

Hardware Fault -If you touch the fan blades while removing the fan filter grill or filter, a **HW FAULT** may occur. This is normal. Clear the **HW FAULT** alarm by using the Silence / Reset button.

REMARQUE

Si vous touchez les pales du ventilateur en enlevant le grillage du filtre ou le filtre du ventilateur, une alarme **HW FAULT** se produira. C'est une situation normale. Effacez l'alarme **HW FAULT** à l'aide du bouton Silence / Remise à zéro.

- 3) Gently bathe the filter in a solution of mild detergent and warm water.
- 4) Rinse thoroughly in warm water.
- 5) Examine the filter for excessive wear or damage. Discard and replace with a new filter if necessary.
- 6) Allow the filter to thoroughly air dry ***before*** reinstallation.
- 7) Reinstall the filter.
- 8) Reposition the filter grill over the filter and apply light pressure until it fully seats ("clicks") into the filter housing.

CAUTION

Wet or Damp Filters - Do not install a wet or damp filter into the LTV® Series ventilators. This could damage the ventilator.

ATTENTION

Filtres mouillés ou humides - Ne pas installer des filtres mouillés ou humides dans les ventilateurs de la série LTV®. Cela pourrait endommager le ventilateur.

Cleaning or replacing the Inlet Filter

To clean the Inlet Filter:

- 1) Remove the Inlet Filter by squeezing the foam filter gently with your fingers and pulling it out.

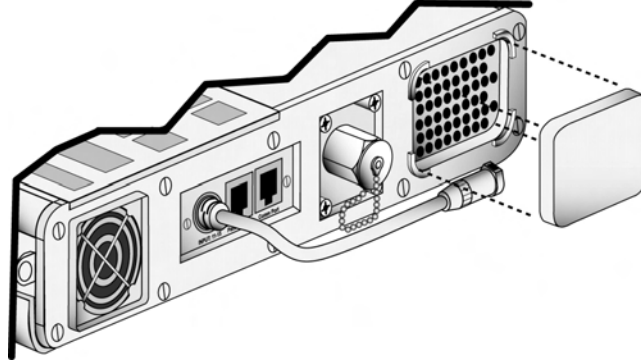

- 2) Gently bathe the filter in a solution of mild detergent and warm water.
- 3) Rinse thoroughly in warm water.
- 4) Examine the filter for excessive wear or damage. Discard and replace with a new filter if necessary.
- 5) Allow the filter to thoroughly air dry ***before*** reinstallation.
- 6) Reinstall the filter.

CAUTION

Wet or Damp Filters - Do not install a wet or damp filter into the LTV® Series ventilators. This could damage the ventilator.

ATTENTION

Filtres mouillés ou humides - Ne pas installer des filtres mouillés ou humides dans les ventilateurs de la série LTV®. Cela pourrait endommager le ventilateur.

Cleaning or Replacing the O₂ Inlet Filter

The O₂ filter should be cleaned or replaced when it becomes soiled. Failure to do this can affect ventilator performance.

CAUTION

Oxygen Supply Contamination - The accuracy of the oxygen delivery capabilities of LTV[®] ventilators can be compromised by foreign debris contamination in the oxygen supply system. To reduce the risk of airborne contaminants entering the ventilator, ensure that any oxygen supply connected to the ventilator is clean, properly filtered⁶⁴ and that the ventilator's O₂ Inlet Port Cap is securely installed on the O₂ Inlet Port whenever the ventilator is not connected to an external oxygen supply.

ATTENTION

Contamination de la réserve d'oxygène - La précision de la capacité d'alimentation en oxygène des ventilateurs LTV[®] peut être compromise par la présence de corps étrangers dans le système d'alimentation en oxygène. Afin de diminuer le risque de présence d'agents contaminants atmosphériques dans le ventilateur, assurez-vous que la réserve d'oxygène reliée au ventilateur est propre et filtrée de manière adéquate⁶⁴, et que le bouchon de l'orifice d'alimentation en oxygène est correctement installé à chaque fois que le ventilateur n'est pas relié à une source d'oxygène externe.

To clean or replace the O₂ Inlet Filter:

- 1) If a high pressure O₂ source is being used, disconnect the high pressure O₂ hose from the oxygen block on the left side of the ventilator.
- 2) If a low pressure O₂ source is being used, disconnect the O₂ line from the barbed oxygen adapter. Unscrew and remove the barbed adapter from the oxygen block on the left side of the ventilator.

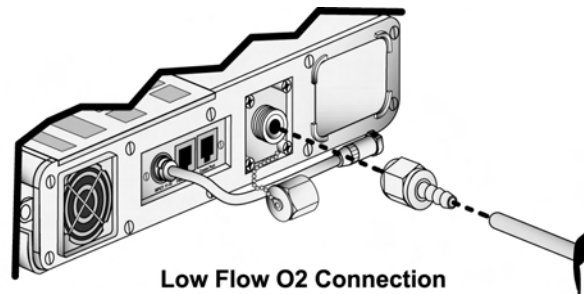
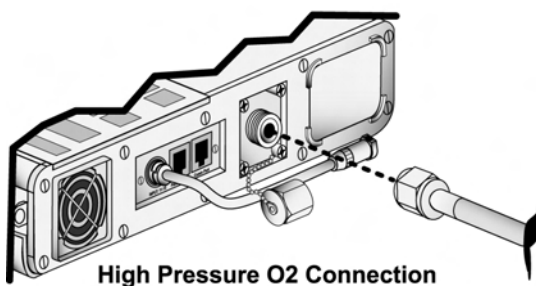

⁶⁴ In addition to the existing internal O₂ Inlet filter, P/N 14313, an External, In-Line Oxygen Filter (P/N 14470) is available from Pulmonetic Systems, Inc.

- 3) Using a pick, gently remove the rubber O-Ring from inside the O₂ inlet port. Use caution: Do not damage the O-Ring while removing it. Tip the ventilator to allow the O₂ Inlet Filter to slide out.

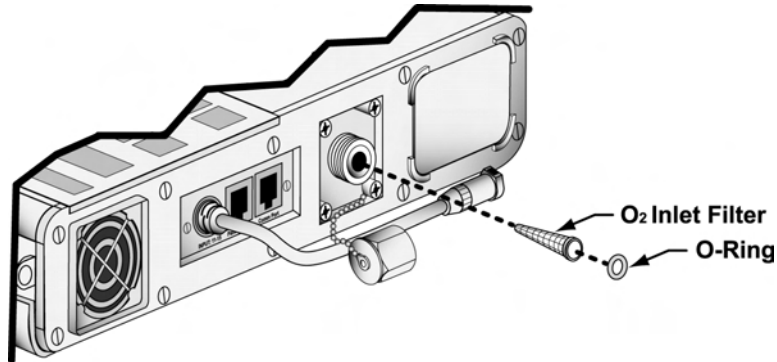

- 4) Clean the filter using a mild cleanser, warm water and a soft brush. Rinse the filter thoroughly to remove all traces of the cleanser. Allow the filter to dry completely before replacing it in the ventilator.
- 5) Inspect the filter for damage. If the filter is not intact, shows signs of damage or cannot be completely cleaned, replace it with a new O₂ Inlet Filter (P/N 14313) and O-Ring (P/N 10609), available from Pulmonetic Systems.
- 6) Replace the filter by sliding it back into the O₂ inlet port. Replace the O-Ring, making sure it is completely tucked under the retaining lip on the inside of the O₂ inlet port.
- 7) Reconnect the high pressure O₂ line or the barbed adapter and low pressure O₂ line.

CAUTION

Wet or Damp Filters - Do not install a wet or damp filter into the LTV[®] Series ventilators. This could damage the ventilator.

ATTENTION

Filtres mouillés ou humides - Ne pas installer des filtres mouillés ou humides dans les ventilateurs de la série LTV[®]. Cela pourrait endommager le ventilateur.

Cleaning the Exhalation Valve and Reusable Patient Circuit

WARNING

Patient Circuits – Pulmonetic Systems' Patient Circuits, Exhalation Valve Assemblies and Water Traps are shipped clean, not sterile.

Ultra Violet Light Sensitivity – The material used in the tubing of the "Reusable" Patient Circuits is not UV stable. Avoid exposure of the tubing to UV light.

AVERTISSEMENT

Circuits du patient – Les circuits du patient du Pulmonetic Systems, les valves expiratoires et les collecteurs d'eau sont expédiés propres, mais pas stériles.

Sensibilité à la lumière ultraviolette – Les matériaux utilisés pour la tubulure des circuits du patient ne sont pas stables sous rayons UV. Éviter d'exposer la tubulure à la lumière UV.

CAUTION

Proximal Sense Lines - Do not remove the proximal sense lines from the patient wye.

Care of the Exhalation Valve - The exhalation valve is a delicate assembly and may be damaged if;

- Care is not exercised when handling or cleaning it.
- Cleaning instruments or foreign bodies are inserted into it.
- High-pressure gas nozzles are used to dry it.

Care of Bacterial Filters – If bacterial filters are used in conjunction with the LTV® Series ventilator, comply with all procedures as specified by the filter manufacturer.

ATTENTION

Conduites de détection – N'enlevez pas les conduites de détection qui se trouvent sur les divisions en Y du circuit du patient.

Entretien de la soupape d'expiration - La soupape d'expiration est une pièce fragile et peut être endommagée si :

- Des précautions ne sont pas prises lors de sa manipulation ou de son nettoyage.
- Des instruments de nettoyage ou des corps étrangers sont insérés dans celle-ci.
- Des pistolets de gaz à haute-pression sont utilisés pour l'assécher

Entretien des filtres bactériens - Les filtres bactériens ne devraient pas être immergés dans un liquide. Un autoclave à vapeur devrait être utilisé pour le nettoyage des filtres bactériens.

To clean the exhalation valve, sense line(s), wye and reusable patient circuit:

For purposes of cleaning, the patient circuit with exhalation valve and all accessories must be detached from the ventilator.

- 1) Disassemble the exhalation valve as shown and remove the diaphragm and compression spring. If using a patient circuit with a PEEP valve; remove the exhalation valve retainer collar (rotate) and pull the PEEP valve assembly off the exhalation valve body. **USE CAUTION:** The diaphragm and spring may become dislodged.
- 2) Remove exhalation valve diaphragm and compression spring.

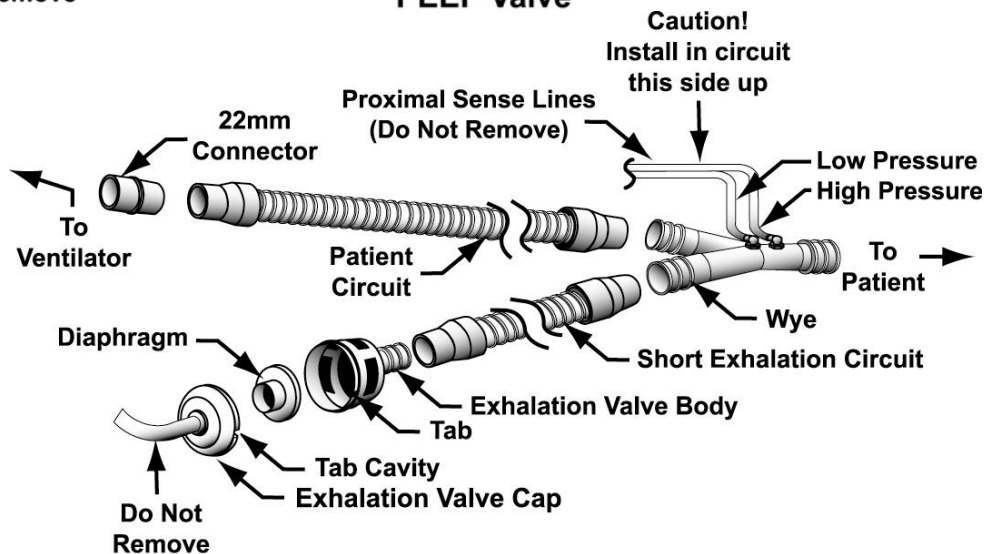
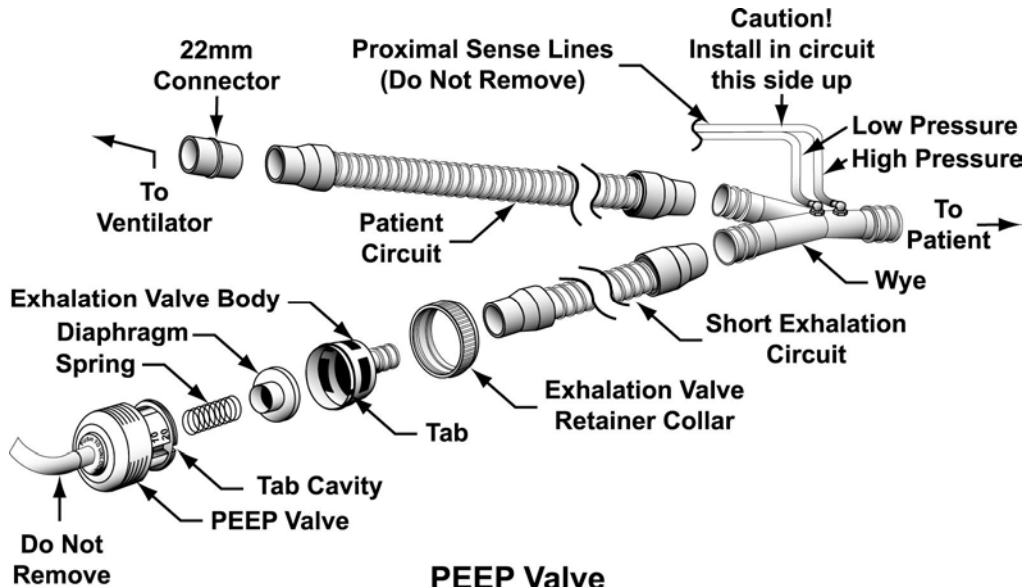

- 3) **To clean** the exhalation valve and patient circuit, remove all gross particulate matter and bathe for a minimum of 10 minutes in 50% water and 50% vinegar, KlenZyme, or another enzymatic cleaner warmed to 95°F to 150°F (35°C to 65.5°C). Rinse gently for 2 minutes and use a low flow air source to eliminate any residual fluid. Ultrasonic cleaning is not recommended. To clean the water trap use a mild detergent solution followed by rinsing and drying with a low-flow air source.

CAUTION

Cleaning the Water Trap – Do NOT use KlenZyme to clean Pulmonetic water traps. It will cause deterioration of the water trap material.

ATTENTION

Nettoyage du piège à eau – NE PAS utiliser KlenZyme pour nettoyer les pièges à eau Pulmonetic. Le cas échéant, le matériau composant le piège à eau se détériorera.

- 4) **To high level disinfect** the exhalation valve, patient circuit or water trap, remove all gross particulate matter and bathe in a glutaraldehyde solution (e.g., Cidex (2%)) for 20 minutes. Rinse gently for 2 minutes. Use a low flow air source to eliminate any residual fluid.
- 5) Exhalation valves, Patient Circuits and Water Traps are shipped clean, not sterile. **Sterilization** of the exhalation valve, reusable patient circuit and water trap should follow individual institution processes or guidelines.

CAUTION

Reusable Patient Circuit Components - To avoid degradation of the reusable patient circuit components, do not exceed the following constraints:

- 50 cleaning cycles or 1 year (whichever comes first)

Steam Autoclave:

- Pressure: 20 PSIG
- Temperature: 275°F (135°C)
- Time: 6 minutes

Liquid Sterilizing Agent:

- The use of liquid agents containing more than 2% glutaraldehyde.

Pasteurization:

- 30-minute warm water detergent and 30-minute 165°F (74°C) hot cycle.
- Drying in a sterile drier for more than 1 hour or 140°F (59°C).

Gas (ETO):

- Temperature: 131°F (55°C)

Care of the Exhalation Valve - The exhalation valve is delicate and may be damaged if;

- Care is not exercised when handling or cleaning it.
- Cleaning instruments or foreign bodies are inserted into it.
- High-pressure gas nozzles are used to dry it.

Differential Pressure Ports - A low pressure air nozzle with flow less than 10 liters per minute should be used for cleaning the differential pressure ports.

Patient Wye Installation – After cleaning, install the patient wye in the patient circuit so the proximal sense lines are oriented up while operating.

ATTENTION

Composants réutilisables du circuit du patient – Pour éviter la dégradation des composants réutilisables du circuit du patient, ne dépassez pas les limites suivantes:

- 50 cycles de nettoyage ou 1 an (le premier des deux prévalant)

Autoclave à vapeur:

- Pression : 20 lb/po²
- Température : 275°F (135°C)
- Durée : 6 minutes

Agent de stérilisation liquide:

- L'utilisation d'agents liquide contenant plus de 2% de glutaraldéhyde.

Pasteurisation:

- Un cycle avec détergent à l'eau tiède pendant 30 minutes et à l'eau chaude à 165°F (74°C) pendant 30 minutes.
- Séchage dans un séchoir stérile pendant plus de 1 heure ou à 140°F (59°C).

Gaz (ETO):

- Température : 131°F (55°C)

Entretien de la soupape d'expiration - La soupape d'expiration est une pièce fragile et peut être endommagée si :

- Des précautions ne sont pas prises lors de sa manipulation ou de son nettoyage.
- Des instruments de nettoyage ou des corps étrangers sont insérés dans celle-ci.
- Des pistolets de gaz à haute-pression sont utilisés pour l'assécher.

Ports de pression différentielle - Une source de gaz à débit faible (moins de 10 ppm) doit être utilisée pour le nettoyage des fluides et de débris des ports de pression différentielle.

Installation de la soupape d'expiration - Après le nettoyage, installez la soupape d'expiration dans le circuit du patient de sorte que les lignes de détection soient alignées vers le haut pendant l'opération.

- 6) Inspect the patient circuit, exhalation valve and all accessories. Replace any excessively worn or damaged components.

To reassemble the exhalation valve:

- 1) Depress the lock and set the PEEP valve to "0".
- 2) Insert the compression spring in the center hole of the PEEP valve. Make sure spring is securely seated inside the PEEP valve.
- 3) Push the diaphragm on top of the spring. Make sure the diaphragm is correctly oriented with the narrow lip fitting up inside the PEEP valve.
- 4) Snap the PEEP valve onto the exhalation valve body, ensuring the tab and cavity are aligned. **BE CAREFUL** not to dislodge the diaphragm when snapping the exhalation body and PEEP body together.
- 5) Slide the Exhalation Valve Retainer Collar over the Exhalation Valve and tighten (rotate) to the PEEP Valve.

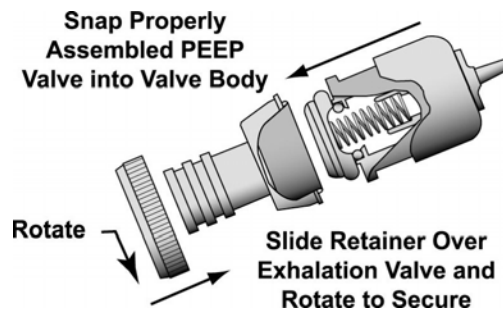
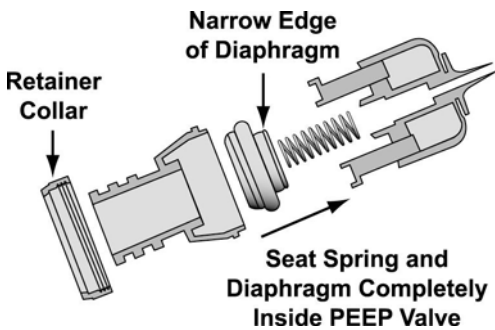

- 6) Replace the exhalation valve in the patient circuit. Reconnect the exhalation valve drive line and sense lines to the ports on the side of the ventilator.

Chapter 14 - POWER AND BATTERY OPERATION

The LTV® Series ventilator operates on Direct Current (11 to 15 VDC), supplied by an external AC to DC power adapter, an external battery or other suitable external DC power source such as the Pulmonetic Systems Universal Power Supply or Transport Battery System. The ventilator can also be powered for short periods of time by its own internal battery (see note below).

- When the ventilator is connected to an appropriate external power source, the ventilator's internal battery is continuously charged and will reach 90% charge status within 8 hours.
- If an LTV® Series ventilator is allowed to operate on its internal battery to the point that the internal battery is completely depleted, the ventilator will shut down. If the ventilator remains in this state, the internal battery may recharge slightly within a few seconds / minutes and cause the ventilator to automatically restart and operate for a short period of time. This cycle can repeat several times, depending on the condition of the internal battery.

NOTE

The **Charge Status** LED is illuminated green when the internal battery is charged to >90% of its capacity. If the **Charge Status** LED is red, is flashing amber for more than 1 hour, or does not show a green Charge Status indication after 24 hours, the battery is defective and should be replaced. Please immediately contact a certified Pulmonetic Systems' service technician.

Internal Battery Use: The internal battery is intended for use during short periods while switching between external power supply connections, emergency situations or short duration transports. The length of time the ventilator will operate on internal power is a function of many factors such as settings, charge level and condition or age of the battery; therefore, the use of the internal battery as a standard operating practice is not recommended.

REMARQUE

Le voyant du DEL **Charge Status** est vert lorsque la pile interne est chargée à plus de 90 % de sa capacité. Si le voyant du DEL **Charge Status** est rouge, qu'il est jaune et clignote pendant plus d'une heure, ou qu'il n'affiche pas un **Charge Status** vert après 24 heures, la pile est défectueuse et il faut la changer. Veuillez communiquer immédiatement avec un technicien de service certifié par Pulmonetic Systems.

Utilisation de la batterie interne: La batterie interne est conçue pour être utilisée sur de courtes périodes pendant la commutation entre des connexions d'alimentation externe, les situations d'urgence ou les transports de courte durée. La durée pendant laquelle le ventilateur fonctionnera sur l'alimentation interne dépend de plusieurs facteurs tels, la configuration, le niveau de la charge et la condition ou l'âge de la batterie; l'utilisation de la batterie interne pour l'opération normale n'est donc pas recommandée.

Using the AC Adapter

To run the ventilator from the Pulmonetic Systems AC Power Adapter:⁶⁵

- 1) Attach the power connector from the AC Adapter to the ventilator as shown here.

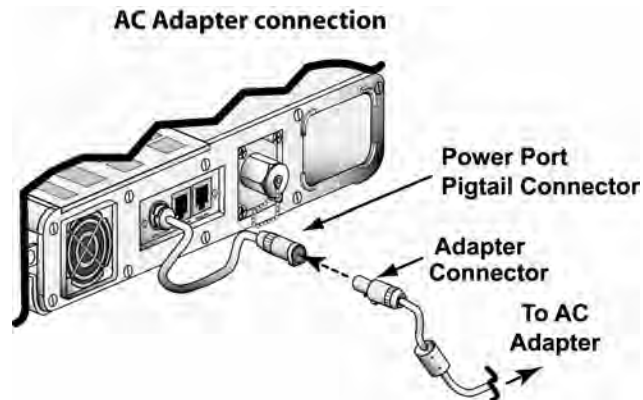

- 2) Connect the proper AC power cable (110V or 220V plug) to the AC Power Adapter.
- 3) Connect the 110V⁶⁶ or 220V power cable to a suitable power source. Verify the **EXTERNAL POWER** LED shows green or amber.

CAUTION

Release Button - To avoid damaging the ventilator or the power connector, push the release button on the connector before removing it from the ventilator power port or the power port pigtail connector.

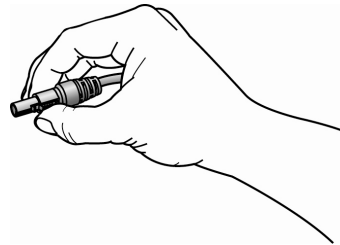

ATTENTION

Bouton de déclenchement – Pour éviter d'endommager le ventilateur ou le connecteur d'alimentation, appuyer sur le bouton de déclenchement situé sur le connecteur avant de le retirer du port d'alimentation du ventilateur ou du raccord de queue de cochon du port d'alimentation.

While the ventilator is plugged in, the internal battery is continuously charged.

⁶⁵ Pulmonetic Systems AC Adapter, P/N 10537

⁶⁶ Pulmonetic Systems Power Cord, P/N 10536

Using an External Battery

Optional External Batteries⁶⁷, Cables⁶⁸ and Charger⁶⁹ are available from Pulmonetic Systems. The Large External Battery Pack includes a large capacity battery and hard case with a fuse and power cable and is pre-wired with a locking quick-connector. The Small External Battery Pack includes a medium capacity battery, soft bag and power cable with fuse and locking quick-connector.

CAUTION

External Battery Pack - The External Battery Pack should only be connected to the LTV[®] Series ventilators using the Pulmonetic Systems External Battery Cable (PN 10802). This cable is pre-wired and properly terminated to ensure safe connection of the External Battery Pack to the ventilator.

Release Button - To avoid damaging the ventilator or the power connector, push the release button on the connector before removing it from the ventilator power port or the power port pigtail connector.

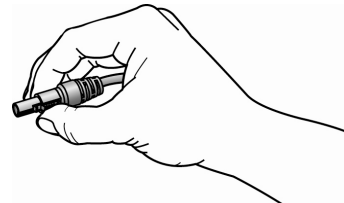

ATTENTION

Bloc-piles externe – Le bloc-piles externe ne doit être branché qu'aux ventilateurs de la série LTV[®] à l'aide du câble pour piles externes de Pulmonetic Systems (N^o pièce 10802). Ce câble est précâblé et ses terminaisons assurent une connexion sécuritaire entre le bloc-piles externe et le ventilateur.

Bouton de déclenchement – Pour éviter d'endommager le ventilateur ou le connecteur d'alimentation, appuyer sur le bouton de déclenchement situé sur le connecteur avant de le retirer du port d'alimentation du ventilateur ou du raccord de queue de cochon du port d'alimentation.

To run the ventilator from an external battery:

- 1) Connect the battery cable quick-connector to the port on the external battery hard case or the soft bag.

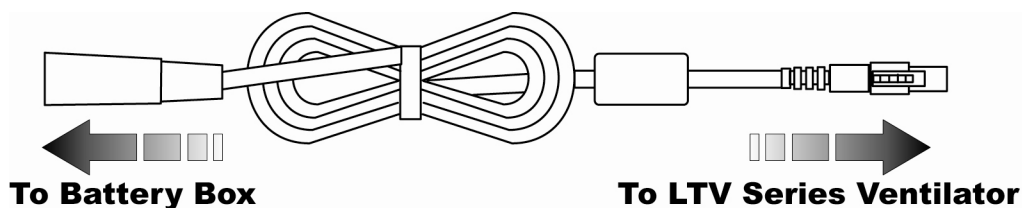

⁶⁷ Pulmonetic Systems External Battery P/N 10787 and Case P/N 10790.

⁶⁸ Pulmonetic Systems External Battery Cable P/N 10802.

⁶⁹ Pulmonetic Systems External Battery Charger P/N 10801.

- 2) Connect the power connector on the battery cable to the power port on the left side of the ventilator as shown here. Verify the **EXTERNAL POWER** LED shows green or amber.

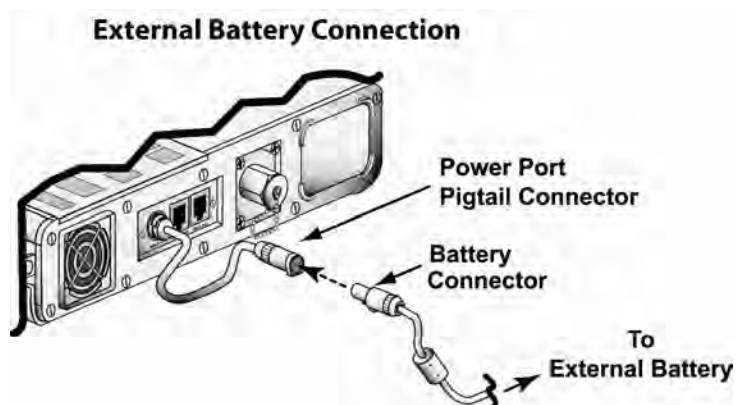

While the ventilator is connected to the external battery, the internal battery is being continuously charged.

NOTE

The External Battery Packs can only be recharged using the Pulmonetic Systems External Battery Charger. The External Battery Pack must be disconnected from the LTV[®] Series ventilator before connecting to the External Battery Charger. The External Battery Pack can be fully recharged in 8 hours. See the instruction sheet that comes with the External Battery Charger for information on how to properly configure the charger for your AC voltage and frequency.

The external battery is a sealed lead acid battery. Some states and countries require that these batteries must be disposed of through an authorized recycling or hazardous materials center. Contact the proper agency for appropriate disposal procedures.

REMARQUE

Les blocs-piles externes ne peuvent être rechargés qu'en utilisant le chargeur de piles externe Pulmonetic Systems. Le bloc-piles externe doit être débranché du ventilateur de la série LTV[®] afin d'être branché au chargeur de piles externe. Il faut 8 heures pour recharger complètement le bloc-piles externe. Consultez la feuille de directives incluse avec le chargeur de piles externe pour obtenir des renseignements sur la façon de configurer adéquatement le chargeur selon la tension alternative et la fréquence dont vous disposez.

La batterie externe est une batterie à l'acide sans entretien. Certains états et pays exigent que l'on dispose de ces piles par l'entremise d'un centre autorisé de recyclage ou de matières dangereuses. Pour connaître les procédures appropriées, communiquez avec l'agence concernée.

For more detailed information on using or charging the external batteries, or for information on replacing battery box or bag fuse, see the *LTV® Series External Battery Kit Operator's Manual*.⁷⁰

The battery may be set and operated from any position, but always secure the battery box in place and keep the battery box in a stable, accessible position near the LTV® Series ventilator. Keep all cords away from footpaths and moveable equipment, and tie them to unmoving surfaces such as the ventilator stand or bed post.

Refer to your *LTV® Series External Battery Kit Operator's Manual* (P/N 10890) for other safety information, extended operating procedures and troubleshooting techniques.

⁷⁰ LTV® Series External Battery Kit Operator's Manual P/N 10890.

Using the Automobile Cigarette Lighter Adapter

An optional Automobile Cigarette Lighter Adapter⁷¹ is available to power the LTV® Series ventilator while operating in a vehicle. This adapter is designed to connect to “high power” pre-wired +12V automobile cigarette lighter or auxiliary power outlets capable of supplying at least 20 amperes of current.

- Newer vehicles have Auxiliary Power Outlets, which typically have lower contact resistance and higher amperage ratings than Automobile Cigarette Lighter Outlets and should be used when available.
- The use of third-party-installed automobile cigarette lighter-style power outlets is not recommended (i.e. on battery boxes or wheelchairs).

WARNING

Before Using Automobile Cigarette Lighter or Power Outlets - Before using Automobile Cigarette Lighter or Power Outlets as a power source for the LTV® ventilator, assure that the ventilator's internal battery is in good condition and fully charged.

Poor cigarette lighter or power outlet connections, electrical system defects (battery, charging system, etc.), or use of vehicle accessories (air conditioner, high current lights, high power audio equipment, etc.) could result in less than the required voltage being delivered to the ventilator. If this condition occurs, the ventilator will generate a **POWER LOST** alarm and switch the ventilator's power source to the internal battery.

AVERTISSEMENT

Avant toute utilisation d'une prise d'allume-cigare ou d'une prise de courant — Avant d'utiliser un allume-cigare ou une prise de courant comme source d'alimentation du ventilateur LTV®, vérifiez que la batterie interne du ventilateur est en bon état et entièrement chargée.

L'utilisation d'un allume-cigare ou d'une prise de courant fournissant un branchement de qualité médiocre, des défauts du circuit électrique (batterie, système de charge, etc.), ou l'utilisation d'accessoires d'automobile (climatisation, phares, chaîne stéréo et haut-parleurs à forte consommation, etc.) peuvent affecter le voltage délivré au ventilateur et provoquer une sous-alimentation de celui-ci. Dans cette situation, le ventilateur déclenche une alarme **PAS ALIM SEC** et utilise la batterie interne du ventilateur comme source d'alimentation.

⁷¹ Pulmonetic Systems Automobile Cigarette Lighter Adapter P/N 10703.

CAUTION

Automobile Cigarette Lighter and Power Outlets - Automobile cigarette lighter and power outlets are normally wired for a positive center contact and ground sleeve contact. Connecting the ventilator to an improperly wired outlet will cause the adapter fuse to blow and may damage the adapter or the ventilator.

Automobile Cigarette Lighter Outlet Power Rating - Running a ventilator from an improperly rated automobile cigarette lighter outlet (less than 20 amperes) may cause a fuse in the automobile to blow, causing the ventilator and possibly other accessories in the automobile to stop operating.

Automobile Cigarette Lighter Adapter - Do not operate the ventilator from the Automobile Cigarette Lighter Adapter while starting the vehicle or when jump starting the automobile. Doing so may cause damage to the ventilator.

Automobile Cigarette Lighter Adapter Tip - Use care when disconnecting the Automobile Cigarette Lighter Adapter after use, its tip may be hot.

Automobile Cigarette Lighter Outlet – Depending on the condition of the automobile battery, whether the automobile is turned off, being started or running, automobile cigarette lighter outlets can provide varying levels of voltage (in some, the outlet only operates when the vehicle is running). Verify which power source the ventilator is using by checking the **EXTERNAL POWER** LED on the ventilator.

ATTENTION

Allume-cigare et prises de courant – L'allume-cigare et les prises de courant sont habituellement câblés de façon à obtenir un contact central positif et un contact du manchon à la terre. Le branchement du ventilateur dans une prise qui n'est pas câblée adéquatement aura pour effet de faire sauter le fusible de l'adaptateur et pourrait endommager l'adaptateur ou le ventilateur.

Puissance nominale des prises d'allume-cigare – Le branchement d'un ventilateur à une prise d'allume-cigare qui ne possède pas la tension suffisante (moins de 20 ampères) peut faire griller un fusible de l'automobile, causant ainsi l'arrêt du ventilateur et éventuellement, celui d'autres accessoires de l'automobile.

Adaptateur pour allume-cigare – Ne faites pas fonctionner le ventilateur à l'aide de l'adaptateur pour allume-cigare lorsque vous démarrez le véhicule ou lorsque vous faites une connexion provisoire de la batterie d'un véhicule. Vous pourriez ainsi endommager le ventilateur.

Embout adaptateur pour allume-cigarette d'automobile - Après l'utilisation, débrancher l'adaptateur pour allume-cigarette d'automobile avec précaution car son embout peut être chaud.

Prise d'allume-cigare d'automobile – Selon la condition de la batterie de l'automobile, si le moteur est coupé, démarré ou est en marche, les prises d'allume-cigare d'une automobile peut générer des niveaux de tension variés (sur certains modèles, la prise ne fonctionne que si le moteur est en marche). Vérifier la source d'alimentation utilisée par le ventilateur indiquée par la DEL **EXTERNAL POWER** du ventilateur.

CAUTION

Release Button - To avoid damaging the ventilator or the power connector, push the release button on the connector before removing it from the ventilator power port or the power port pigtail connector.

ATTENTION

Bouton de déclenchement – Pour éviter d'endommager le ventilateur ou le connecteur d'alimentation, appuyer sur le bouton de déclenchement situé sur le connecteur avant de le retirer du port d'alimentation du ventilateur ou du raccord de queue de cochon du port d'alimentation.

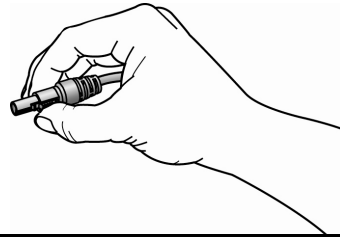

To run the ventilator from an automobile cigarette lighter:

- 1) With the ventilator **NOT** connected to the outlet, start the automobile.
- 2) Connect the Automobile Cigarette Lighter Adapter to the automobile cigarette lighter or power outlet on the vehicle and verify the LED on the adapter shows green.
 - Do not use a DC extension cord between the automobile cigarette lighter adapter and the automobile cigarette lighter or power outlet port.



- 3) Attach the power connector of the adapter to the ventilator.

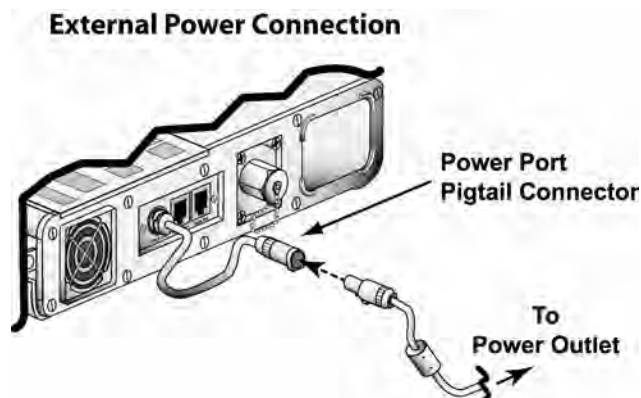

- 4) Verify the ventilator is being powered by the vehicle battery, through the Automobile Cigarette Lighter Adapter.
- The vehicle battery is powering the ventilator if the **EXTERNAL POWER** LED shows green.
 - An amber **EXTERNAL POWER** LED and/or a **POWER LOW** alarm indicates the external power level is low.
Immediately reconnect the ventilator to an alternate power source (i.e. the AC Adapter or External Battery) until the cause of the problem (Automobile Cigarette Lighter Adapter cable connection or the vehicle battery or power outlet), has been identified and corrected.

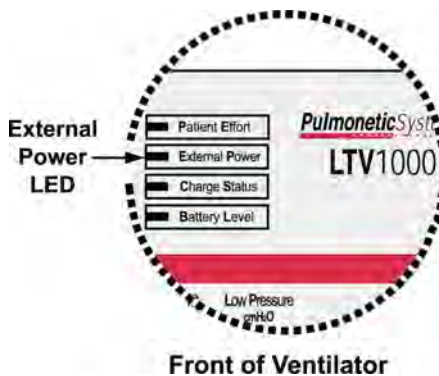

- A **POWER LOST** alarm indicates external power voltage has dropped below the usable level and the ventilator has switched to internal power.
Immediately reconnect the ventilator to an alternate power source (i.e. the AC Adapter or External Battery) until the cause of the problem (Automobile Cigarette Lighter Adapter cable connection or the vehicle battery or power outlet), has been identified and corrected.

NOTE

The Automobile Cigarette Lighter Adapter contains a fuse and is designed to protect the LTV® Series ventilators from typical automobile power transients. The green LED on the adapter indicates the adapter is connected and operating correctly. If the LED does not light, the adapter may not be properly seated in the outlet or the fuse may be blown. Try reseating or turning the adapter to create a better connection or change the fuse (see *Chapter 14 - Replacing the Automobile Adapter Fuse*).

REMARQUE

L'adaptateur pour allume-cigare contient un fusible et est conçu pour protéger les ventilateurs de la série LTV® contre les transitoires d'alimentation des automobiles. Le voyant DEL vert de l'adaptateur indique que l'adaptateur est branché et qu'il fonctionne adéquatement. Si le voyant ne s'allume pas, l'adaptateur n'est peut-être pas bien installé dans la prise ou le fusible est peut-être sauté. Essayez de replacer ou de tourner l'adaptateur de manière à obtenir un meilleur raccordement ou changer le fusible (se reporter au *Chapitre 14 – Remplacement du fusible de l'adaptateur*).

While the ventilator is connected to the Automobile Cigarette Lighter Adapter, the internal battery is being continuously charged.

Replacing the Automobile Adapter Fuse

To replace the fuse:

- 1) Unscrew the knurled nut.
- 2) Remove the contact point, nut, fuse and spring as shown below. Be careful not to lose the internal spring, as the adapter will not operate correctly without it.
- 3) Replace the spring and new fuse as shown.
- 4) Ensure that the retaining ring is properly in place.
- 5) Replace the contact point and tighten the nut.

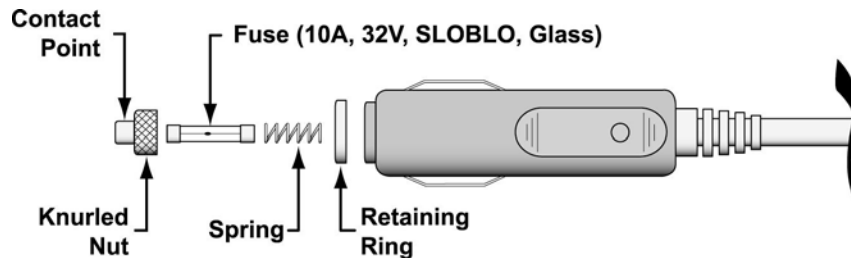

The Universal Power Supply (UPS)

The Pulmonetic Systems Universal Power Supply kit is a rechargeable external power source and backup system for Pulmonetic Systems' devices. It has the following features:

- AC/DC Converter
- Backup Battery Charger
- Power and charge status LED
- Audible and visual alarms to indicate loss of mains power

The Universal Power supply provides an AC derived DC power source which is backed up by a rechargeable 12 volt sealed lead - acid battery. It can power the ventilator and the graphics monitor. For more information refer to the UPS Operator's Manual P/N 14492

The Transport Battery System (TBS)

The TBS is a portable, re-chargeable external power source for the LTV® ventilator series. It has the following features:

- Two no-maintenance re-chargeable Lithium Ion batteries providing up to six hours of mobile power for the LTV®.
- The TBS is easy and convenient to set-up and operate and the system includes a battery charger for use when the TBS has been disconnected from the ventilator

For more information about the TBS, see the Transport Battery System Operator's Manual P/N 17216-001.

Caring for the Internal Battery

The LTV[®] Series ventilator uses a rechargeable, sealed lead acid internal battery.

To preserve maximum battery life:

- Fully recharge the battery every 2 months while the ventilator is in storage. Recharge the battery by plugging the ventilator into an AC power source for 24 hours. If the battery **Charge Status** LED is not illuminated green within 24 hours, or if it is illuminated red, immediately contact a certified Pulmonetic Systems' service technician or Pulmonetic Systems.
- Store the ventilator at temperatures less than 60°C (140°F).

CAUTION

Storage Temperature - Storing the LTV[®] Series ventilator at temperatures above 60°C (140°F) for long periods can damage the internal battery and cause expected battery duration to degrade.

Internal Battery Use: The internal battery is intended for use during short periods while switching between external power supply connections, emergency situations or short duration transports. The length of time the ventilator will operate on internal power is a function of many factors such as settings, charge level and condition or age of the battery; therefore, the use of the internal battery as a standard operating practice is not recommended.

ATTENTION

Température d'entreposage - L'entreposage du ventilateur de la série LTV[®] à des températures supérieures à 60° C (140° F) durant des périodes prolongées peut endommager la pile interne et causer l'usure prématurée de la pile.

Utilisation de la batterie interne: La batterie interne est conçue pour être utilisée sur de courtes périodes pendant la commutation entre des connexions d'alimentation externe, les situations d'urgence ou les transports de courte durée. La durée pendant laquelle le ventilateur fonctionnera sur l'alimentation interne dépend de plusieurs facteurs tels, la configuration, le niveau de la charge et la condition ou l'âge de la batterie; l'utilisation de la batterie interne pour l'opération normale n'est donc pas recommandée.

Battery Disposal

The LTV[®] Series ventilator uses sealed lead acid batteries. Some jurisdictions consider these batteries hazardous materials subject to special disposal regulations. Contact the proper agency for information on permissible methods of disposing of used batteries.

Chapter 15 - TROUBLESHOOTING

This chapter describes troubleshooting for the LTV[®] Series ventilator. Some problems can result from improper operation and can easily be corrected without any modification to the ventilator. Other problems may require that the ventilator be recalibrated or have parts replaced.

Do not attempt to repair or replace any part of the ventilator unless you are trained and authorized for service on the LTV[®] Series ventilator.

This chapter is organized into five sections:

Displays and Buttons (See page 15-2)	Includes problems with control and window displays and with setting controls.
Ventilator Performance (See page 15-5)	Includes problems with delivered or monitored pressure, volume or PEEP, accuracy, sensitivity and triggering.
Power and Battery Operation (See page 15-14)	Includes problems with turning the ventilator on, operating from external power sources, battery operation or duration, and vent inops.
Alarms (See page 15-16)	Includes problems with recurring alarms.
Checkout Test Failures (See page 15-21)	Includes problems detected while performing the VENT CHECK tests.
Test Lung Operation (See page 15-23)	Includes problems encountered when operating the ventilator with a test lung.

The troubleshooting tables are organized by symptom, then by possible causes and methods of diagnosing and resolving the problem. If you do not find the symptom you are looking for under one section, you may find it listed under another section, or you may be able to diagnose the problem by reading sections with related symptoms. For information on resolving problems that are not listed here, contact Pulmonetic Systems.

Displays and Buttons

Some of the symptoms listed in this section are part of the normal operation of the ventilator and do not indicate any problem with the ventilator. They are included here for completeness.

Symptoms	Possible Causes	What to Do
Pressure Control display flashing.	Pressure Control breath terminated by flow - PC FLOW TERM is set to on.	Pressure Control breaths are normally terminated when the set inspiratory time expires. Flow termination of Pressure Control breaths is allowed when PC FLOW TERM is set to ON (see page 10-11.) When a Pressure Control breath is terminated by flow instead of time, the Pres Control display is flashed.
Pressure Support display flashing.	Pressure support breath terminated by time - set under TIME TERM .	Pressure support breaths are normally terminated when the flow drops below the set percentage of the peak flow. Pressure support breaths may also terminate on time when the variable time limit is reached before the flow drops to the set level. (See pages 10-9 and 10-10 for an explanation of the FLOW TERM and TIME TERM features.) When a pressure support breath is terminated based on time, the Pres Support display is flashed.
High Pres Limit display flashing.	HIGH PRES alarm occurred.	The High Pres Limit display is flashed and the HIGH PRES message is displayed when a high pressure alarm occurs. The display will continue to flash even after the condition clears. (See page 6-4 for an explanation of the HIGH PRES alarm feature.)
Low Pressure display flashing.	LOW PRES alarm occurred.	The Low Pressure display is flashed and the LOW PRES message is displayed when a low pressure alarm occurs. The display will continue to flash even after the condition clears. (See page 6-12 for an explanation of the LOW PRES alarm feature.)
Low Min Vol display flashing.	LOW MIN VOL alarm occurred.	The Low Min Vol display is flashed and the LOW MIN VOL message is displayed when a low minute volume alarm occurs. The display will continue to flash even after the condition clears. (See page 6-11 for an explanation of the LOW MIN VOL alarm feature.)
O ₂ % (O ₂ Flush) display flashing.	LOW O₂ PRES or HIGH O₂ PRES alarm occurred.	The O ₂ % (O ₂ Flush) display is flashed and the LOW O₂ PRES or HIGH O₂ PRES message is displayed when a low or high O ₂ pressure alarm occurs. The display will continue to flash even after the condition clears. (See pages 9-19 and 9-12 for an explanation of the LOW O₂ PRES and HIGH O₂ PRES alarm features.)

Symptoms	Possible Causes	What to Do
Control display flashing when setting a control.	Control setting is limited.	A control's value may be limited by the current settings of other controls. (See page 5-6 for an explanation of Control Limiting .)
A display or LED does not illuminate.	Internal problem with the ventilator.	Do a display test (see page 11-4 for instructions.) If the display or LED does not illuminate, immediately contact a certified Pulmonetic Systems' service technician.
Ventilator is running but displays are turned off.	Displays are blanked while on battery power.	To conserve battery life while running from the internal battery, most of the displays are turned off when no changes are made to the control settings for 60 seconds. To turn the displays back on, touch any control or button or turn the Set Value knob.
	Internal problem with the ventilator.	Do a display test (see page 11-4 for instructions.) If the display or LED does not illuminate, immediately contact a certified Pulmonetic Systems' service technician.
A control doesn't operate. Set Value knob doesn't operate.	Control not active in selected mode.	If a control is dimmed, it is not active in the currently selected mode and changing it's setting does not affect ventilation. (See page 5-5 for an explanation of Bright, Dim and Blank Control Displays.)
	Controls are locked.	If the controls are locked, a LOCKED message will be displayed when a control is selected. To unlock in EASY mode, push the Control Lock button. To unlock in HARD mode, push and hold the Control Lock button for 3 seconds. (See page 10-15 for an explanation of the CTRL UNLOCK feature and Control Lock button.)
	Control is not selected.	Before a control value can be changed, the control must be selected. To select a control, push the associated button. When a control is selected it is displayed at normal intensity and all other controls are dimmed. (See page 5-2 for an explanation of how to use the controls.)
	Controls are limited.	A control's value may be limited by the current settings of other controls. To change the value of the current control, change the value of the flashing controls. (See page 5-6 for an explanation of Control Limiting .)
	Internal problem with the ventilator.	Do a control test (see page 11-6 for instructions.) If the control does not operate, immediately contact a certified Pulmonetic Systems' service technician.

Symptoms	Possible Causes	What to Do
Can't unlock the controls.	Hard unlock method selected under CTRL UNLOCK .	Two unlock methods are available on the LTV [®] Series ventilator: (See pages 5-7 and 10-15 for an explanation of CTRL UNLOCK .) To unlock in EASY mode, push the Control Lock button. To unlock in HARD mode, push and hold the Control Lock button for 3 seconds.
Volume / Pressure Mode button does not operate, both LEDs are off.	Wrong model selected in maintenance mode.	Immediately contact a certified Pulmonetic Systems' service technician.
Pressure Control button does not operate, associated display is off.	Wrong model selected in maintenance mode.	Immediately contact a certified Pulmonetic Systems' service technician.
O ₂ % (O ₂ Flush) button does not operate, associated display is off.	Wrong model selected in maintenance mode.	Immediately contact a certified Pulmonetic Systems' service technician.
Low Pressure O ₂ Source button associated LED does not operate.	Wrong model selected in maintenance mode.	Immediately contact a certified Pulmonetic Systems' service technician.
LMV OFF is displayed.	Low Minute Volume alarm is turned off.	This is an informational message only (see <i>Chapter 9 - LMV OFF</i> for an explanation of this feature).
LMV LPPS OFF is displayed.	Low Minute Volume alarm is turned off and the LPP ALARM has been set to VC/PC ONLY.	This is an informational message only (see <i>Chapter 9 - LMV LPPS OFF</i> for an explanation of this feature).
LPPS OFF is displayed.	LPP ALARM has been set to VC/PC ONLY.	This is an informational message only (see <i>Chapter 9 - LPPS OFF</i> for an explanation of this feature).
f PEEP OFF is displayed.	The High Breath Rate and High PEEP alarms are turned off.	This is an informational message only (see <i>Chapter 9 - f PEEP OFF</i> for an explanation of this feature).
HI PEEP OFF is displayed.	The High PEEP alarm is turned off.	This is an informational message only (see <i>Chapter 9 - HI PEEP OFF</i> for an explanation of this feature).
HIGH f OFF is displayed.	The High Breath Rate alarm is turned off.	This is an informational message only (see <i>Chapter 9 - HIGH f OFF</i> for an explanation of this feature).

Ventilator Performance

Symptoms	Possible Causes	What to Do
Ventilator is autocycling, monitored volumes are very small, RT XDCR DATA item FTx shows negative flows during exhalation and positive flows during inspiration.	Sense lines are reversed.	The sense lines are not designed to be removed from either the wye or the luer fittings. If the sense lines have been removed and replaced incorrectly, they may not seal correctly when replaced. Replace the patient wye and sense lines with a known good assembly.
Ventilator won't allow patient to exhale.	Diaphragm installed backwards or incorrectly seated in exhalation valve.	Open the exhalation valve and remove the diaphragm and spring. Reseat the spring and diaphragm valve and snap the peep valve or peepless valve cap back in place. See page 13-10 for a diagram of correct exhalation valve assembly.
	Sense lines occluded or pinched.	Check high and low pressure sense lines to be sure they are correctly attached and securely seated at both the ventilator and wye ends. Verify lines are not occluded or pinched.
	Internal problem with the ventilator.	Immediately contact a certified Pulmonetic Systems' service technician.
Set pressure not reached and turbine is humming. Turbine sounds like inspiration even during exhalation.	Failed calibration or internal problem with the ventilator.	Immediately contact a certified Pulmonetic Systems' service technician.
Monitored volume is high. Delivered volume is high.	Very small ET tube connected directly to wye.	A very small ET tube connected directly to the wye may cause turbulence that causes the flow differential to be read incorrectly. To reduce this turbulence, add a short larger bore extension between the ET tube and wye. In this case, the monitored volume is high, but the delivered volume is accurate.

Symptoms	Possible Causes	What to Do
<p>continued...</p> <p><i>Monitored volume is high.</i></p> <p><i>Delivered volume is high.</i></p>	<p>Low side sense line or elbow at patient wye loose or leaking.</p> <p>High or low sense lines are occluded.</p> <p>High or low sense ports in the wye are occluded.</p>	<p>Check high and low pressure sense lines to be sure they are correctly attached and securely seated at both the ventilator and wye ends.</p> <p>Check the luer fitting connections for leaks.</p> <p>Check the elbow connectors at the wye to be sure they have not loosened or been broken loose.</p> <p>Verify lines are not occluded or pinched.</p>
	<p>Sense lines are reversed.</p>	<p>The sense lines are not designed to be removed from either the wye or the luer fittings. If the sense lines have been removed and replaced incorrectly, they may not seal correctly when replaced. Replace the patient wye and sense lines with a known good assembly.</p>
	<p>Failed autozero.</p>	<p>Perform an autozero under XDCR ZERO. See page 10-23 for more information.</p>
	<p>Failed calibration or internal problem with the ventilator.</p>	<p>Immediately contact a certified Pulmonetic Systems' service technician.</p>
<p>Delivered volume is twice the set volume.</p>	<p>VHome setting does not match flow valve.</p>	<p>Immediately contact a certified Pulmonetic Systems' service technician.</p>
<p>Monitored volume is low.</p> <p>Delivered volume is low.</p>	<p>Circuit leak.</p>	<p>Do a leak test and reseal or replace the leaking parts or connections. See page 11-8 for instructions.</p>
	<p>High or low side sense line or elbow at patient wye loose or leaking.</p> <p>High or low sense lines are occluded.</p> <p>High or low sense ports in the wye are occluded.</p>	<p>Check high and low pressure sense lines to be sure they are correctly attached and securely seated at both the ventilator and wye ends.</p> <p>Check the luer fitting connections for leaks.</p> <p>Check the elbow connectors at the wye to be sure they have not loosened or been broken loose.</p> <p>Verify lines are not occluded or pinched.</p>

Symptoms	Possible Causes	What to Do
<p>continued... <i>Monitored volume is low.</i> <i>Delivered volume is low.</i></p>	<p>Exhalation drive line leaking or loose. Exhalation valve leaking during inspiration.</p>	<p>Check the exhalation drive line at both the ventilator and exhalation valve ends. Verify the line is securely seated and not leaking. Verify the exhalation valve is not leaking during inspiration. If it is leaking, open the exhalation valve and remove the diaphragm and spring. Reseat the spring and diaphragm valve and snap the peep valve back in place. See page 13-10 for a diagram of correct exhalation valve assembly. If necessary, replace the exhalation diaphragm, PEEP spring or exhalation valve with a new one.</p>
	<p>Sense lines are reversed.</p>	<p>The sense lines are not designed to be removed from either the wye or the luer fittings. If the sense lines have been removed and replaced incorrectly, they may not seal correctly when replaced. Replace the patient wye and sense lines with a known good assembly.</p>
	<p>Leak Compensation is not on.</p>	<p>Verify that the Leak Compensation extended features option is set to On (default setting is on). See page 10-12 for instructions.</p>
	<p>Failed autozero.</p>	<p>Perform an autozero under XDCR ZERO. See page 10-23 for more information.</p>
	<p>Failed calibration or internal problem with the ventilator.</p>	<p>Immediately contact a certified Pulmonetic Systems' service technician.</p>
<p>Delivered volume is half the set volume.</p>	<p>VHome setting does not match flow valve.</p>	<p>Immediately contact a certified Pulmonetic Systems' service technician.</p>
<p>Delivered pressure is low, PEEP is low, ventilator is autocycling. Delivered pressure is low. Monitored pressure is low.</p>	<p>Circuit leak.</p>	<p>Run a leak test and reseat or replace the leaking parts or connections. See page 11-8 for instructions.</p>

Symptoms	Possible Causes	What to Do
<p>Continued... <i>Delivered pressure is low, PEEP is low, ventilator is autocycling.</i> <i>Delivered pressure is low.</i> <i>Monitored pressure is low.</i></p>	<p>High or low side sense line or elbow at patient wye loose or leaking.</p> <p>High or low sense lines are occluded.</p> <p>High or low sense ports in the wye are occluded.</p>	<p>Check high and low pressure sense lines to be sure they are correctly attached and securely seated at both the ventilator and wye ends.</p> <p>Check the luer fitting connections for leaks.</p> <p>Check the elbow connectors at the wye to be sure they have not loosened or been broken loose.</p> <p>Verify lines are not occluded or pinched.</p> <p>Check the exhalation drive line at both the ventilator and exhalation valve ends. Verify the line is securely seated and not leaking.</p>
	<p>Exhalation drive line leaking or loose.</p> <p>Exhalation valve leaking during inspiration.</p>	<p>Check the exhalation drive line at both the ventilator and exhalation valve ends. Verify the line is securely seated and not leaking.</p> <p>Verify the exhalation valve is not leaking during inspiration. If it is leaking, open the exhalation valve and remove the diaphragm and spring. Reseat the spring and diaphragm valve and snap the peep valve back in place. See page 13-10 for a diagram of correct exhalation valve assembly.</p> <p>If necessary, replace the exhalation diaphragm, PEEP spring or exhalation valve with a new one.</p>
	<p>Sense lines are reversed.</p>	<p>The sense lines are not designed to be removed from either the wye or the luer fittings. If the sense lines have been removed and replaced incorrectly, they may not seal correctly when replaced. Replace the patient wye and sense lines with a known good assembly.</p>
	<p>Leak Compensation is not on.</p>	<p>Verify that the Leak Compensation extended features option is set to On (default setting is on). See page 10-12 for instructions.</p>
	<p>Failed autozero.</p>	<p>Perform an autozero under XDCR ZERO. See page 10-23 for more information.</p>
	<p>Failed calibration or internal problem with the ventilator.</p>	<p>Immediately contact a certified Pulmonetic Systems' service technician.</p>

Symptoms	Possible Causes	What to Do
Delivered pressure is high. Monitored pressure is high.	Diaphragm is incorrectly seated in exhalation valve.	Open the exhalation valve and remove the diaphragm and spring. Reseat the spring and diaphragm valve and snap the peep valve or peepless valve cap back in place. See page 13-10 for a diagram of correct exhalation valve assembly.
	High or low side sense line or elbow at patient wye loose or leaking. High or low sense lines are occluded. High or low sense ports in the wye are occluded.	Check high and low pressure sense lines to be sure they are correctly attached and securely seated at both the ventilator and wye ends. Check the luer fitting connections for leaks. Check the elbow connectors at the wye to be sure they have not loosened or been broken loose. Verify lines are not occluded or pinched. Check the exhalation drive line at both the ventilator and exhalation valve ends. Verify the line is securely seated and not leaking.
	Failed autozero.	Perform an autozero under XDCR ZERO . See page 10-23 for more information.
	Failed calibration or internal problem with the ventilator.	Immediately contact a certified Pulmonetic Systems' service technician.
Delivered pressure increases towards end of inspiration.	VHome setting does not match flow valve.	Immediately contact a certified Pulmonetic Systems' service technician.
Delivered flow is high. Delivered flow is low.	Disconnected Exhalation Drive Line. Leaks in the Patient Circuit.	Verify lines are not occluded or pinched. Check the exhalation drive line at both the ventilator and exhalation valve ends. Verify the line is securely seated and not leaking.
	Failed autozero.	Perform an autozero under XDCR ZERO . See page 10-23 for more information.
	Failed calibration or internal problem with the ventilator.	Immediately contact a certified Pulmonetic Systems' service technician.
Bias flow is 20 lpm or 5 lpm instead of 10 lpm.	VHome setting does not match flow valve.	Immediately contact a certified Pulmonetic Systems' service technician.

Symptoms	Possible Causes	What to Do
Sensitivity does not appear to be accurate. Ventilator is autocycling.	Circuit leak.	Run a leak test and reseal or replace the leaking parts or connections. See page 11-8 for instructions.
	Sense lines are reversed.	The sense lines are not designed to be removed from either the wye or the luer fittings. If the sense lines have been removed and replaced incorrectly, they may not seal correctly when replaced. Replace the patient wye and sense lines with a known good assembly.
	High or low side sense line or elbow at patient wye loose or leaking. High or low sense lines are occluded. High or low sense ports in the wye are occluded.	Check high and low pressure sense lines to be sure they are correctly attached and securely seated at both the ventilator and wye ends. Check the luer fitting connections for leaks. Check the elbow connectors at the wye to be sure they have not loosened or been broken loose. Verify lines are not occluded or pinched. Check the exhalation drive line at both the ventilator and exhalation valve ends. Verify the line is securely seated and not leaking.
	Pressure Control or Pressure Support set below PEEP.	Verify the control values are appropriately set.
	Failed autozero.	Perform an autozero under XDCR ZERO . See page 10-23 for more information.
	Leak Compensation is not on.	Verify that the Leak Compensation extended features option is set to On (default setting is on). See page 10-12 for instructions.
	Failed calibration or internal problem with the ventilator.	Immediately contact a certified Pulmonetic Systems' service technician.
O ₂ % is high.	O ₂ inlet pressure too high when Low O ₂ Source selected. O ₂ inlet flow too high when Low O ₂ Source selected.	Verify the low pressure O ₂ inlet has been correctly calculated and set using the Input O ₂ Flow Chart (see page 6-15). Pulmonetic Systems recommends the use of an O ₂ monitor to verify delivered O ₂ %. Adjust the entrained O ₂ flow so the monitored value shows the desired FIO ₂ . (See pages 6-13 and 6-18 for information on using the Low O ₂ Source and O ₂ % features.)

Symptoms	Possible Causes	What to Do
Continued... <i>O₂% is high.</i>	Low O ₂ Source incorrectly selected.	Verify that the Low O ₂ Source is on when using a low flow, low pressure source and off when using a high pressure source. (See pages 6-13 and 6-18 for information on using the Low O ₂ Source and O ₂ % features.)
	Failed calibration or internal problem with the ventilator.	Immediately contact a certified Pulmonetic Systems' service technician.
	VHome setting does not match flow valve.	Immediately contact a certified Pulmonetic Systems' service technician.
<i>O₂% is low.</i>	O ₂ inlet flow too low when Low O ₂ Source selected.	Verify the low pressure O ₂ inlet has been correctly calculated and set using the Input O ₂ Flow Chart (see page 6-15). Pulmonetic Systems recommends the use of an O ₂ monitor to verify delivered O ₂ %. Adjust the entrained O ₂ flow so the monitored value shows the desired FIO ₂ . (See pages 6-13 and 6-18 for information on using the Low O ₂ Source and O ₂ % features.)
	Failed calibration or internal problem with the ventilator.	Immediately contact a certified Pulmonetic Systems' service technician.
	VHome setting does not match flow valve.	Immediately contact a certified Pulmonetic Systems' service technician.
PEEP not working. PEEP low. PEEP sags during exhalation.	Circuit leak.	The LTV [®] Series ventilator does not actively drive the exhalation valve to maintain PEEP. If there is a significant leak, the PEEP will drop over a long exhalation. Run a leak test and reseal or replace the leaking parts or connections. See page 11-8 for instructions.
	PEEP spring not installed in exhalation valve. Diaphragm incorrectly seated in exhalation valve. Diaphragm installed backwards. Worn PEEP spring.	Open the exhalation valve and remove the diaphragm and spring. Reseat the spring and diaphragm valve and snap the peep valve back in place. See page 13-10 for a diagram of correct exhalation valve assembly. If necessary, replace the PEEP spring with a new one.

Symptoms	Possible Causes	What to Do
Continued... <i>PEEP not working.</i> <i>PEEP low.</i> <i>PEEP sags during exhalation.</i>	High side sense line or elbow at patient wye loose or leaking.	Check high and low pressure sense lines to be sure they are correctly attached and securely seated at both the ventilator and wye ends. Check the luer fitting connections for leaks. Check the elbow connectors at the wye to be sure they have not loosened or been broken loose. Verify lines are not occluded or pinched.
	Failed calibration or internal problem with the ventilator.	Immediately contact a certified Pulmonetic Systems' service technician.
Ventilator won't trigger at sensitivity setting of 1 Lpm.	Patient effort inadequate.	Some very small patients and patients with very weak inspiratory efforts may not be able to generate a 1 Lpm effort.
	Failed autozero.	Perform an autozero under XDCR ZERO . See page 10-23 for more information.
	Leak Compensation is not on.	Verify that the Leak Compensation extended features option is set to On (default setting is on). See page 10-12 for instructions.
	Failed calibration or internal problem with the ventilator.	Immediately contact a certified Pulmonetic Systems' service technician.
Condensation in sense lines.	High or low sense lines are occluded. High or low sense ports in the wye are occluded.	Verify lines are not occluded or pinched and/or clear the lines with a low flow (less than 10 lpm) gas source.
	Defective purge solenoids.	Immediately contact a certified Pulmonetic Systems' service technician.
Ventilator is on, gas is not delivered and turbine is running.	Failed calibration or internal problem with the ventilator.	Immediately contact a certified Pulmonetic Systems' service technician.
Ventilator makes a high pitched noise when in Standby.	Battery charge circuit running.	When the battery charge circuit is running in bulk charge (the Charge Status LED is amber) the ventilator may emit a high pitched sound that some people can hear. This is normal.

Symptoms	Possible Causes	What to Do
Ventilator gets excessively hot.	Patient circuit leaks. Ventilator must run harder to maintain PEEP.	Perform a Leak Test and reseal or replace the leaking parts or connections. See page 11-8 for instructions.
	Internal problem with the ventilator.	Immediately contact a certified Pulmonetic Systems' service technician.
Ventilator does not work with LTM Graphics Monitor.	Communications setting is not set to MONITOR mode.	Set communications setting to MONITOR mode. See page 10-16 for instructions.
	Ventilator requires upgrades to be compatible with LTM Graphics Monitor.	Check LTM compatibility in the Model Number menu. See page 10-19 for instructions. If the ventilator is not LTM compatible, it will require upgrading by a certified Pulmonetic Systems' service technician to accommodate the LTM Graphics Monitor.
	Defective connections between the LTM Graphics Monitor and the ventilator.	Check the Communications Data Cable connection between the ventilator's communications port and the LTM Graphics Monitor's Data Port. See the <i>LTM Graphics Monitor Operator's Manual</i> , P/N 11010, for detailed instructions.

Power and Battery Operation

Problem	Possible Causes	What To Do
The ventilator does not power up.	Faulty power connection, AC power source or adapter and depleted internal battery.	Verify the power cord for the AC adapter is fully seated. Connect the ventilator to a verified source of AC power. Allow the internal battery to charge a minimum of 8 hours.
	Internal problem with the ventilator.	Immediately contact a certified Pulmonetic Systems' service technician.
Vent Inop LED is on and ventilator is not ventilating.	Vent in Standby.	After the vent has been turned off and the external power is reconnected, the Vent Inop LED is lit. This is normal. Push the On / Standby button to turn ventilator on.
	Ventilator was running on internal battery and battery became depleted.	Connect the ventilator to a good external power source.
	Vent Inop.	Power up the vent and check the EVENT TRACE for events indicating the reason for inop. See page E-1 for information on reading the event trace.
	Internal problem with the ventilator.	Immediately contact a certified Pulmonetic Systems' service technician.
The ventilator doesn't operate from external power.	Defective AC source. AC adapter power cord loose.	Make sure the AC adapter is securely plugged into a verified source of AC power and is securely connected to the ventilator. Verify the power cord for the adapter is fully seated.
	Defective AC adapter.	Replace the AC adapter.
	Internal problem with the ventilator.	Immediately contact a certified Pulmonetic Systems' service technician.
The ventilator does not operate from internal battery. The ventilator shuts off when external power is removed.	Internal battery depleted.	If the internal battery is depleted, charge the internal battery for 8 hours by connecting the external AC adapter and plugging it into a good AC source.
	Internal problem with the ventilator.	Immediately contact a certified Pulmonetic Systems' service technician.

Problem	Possible Causes	What To Do
Battery doesn't reach full charge. Battery depletes too quickly.	Internal battery deeply discharged.	Charge the internal battery for 24 hours by connecting the external AC adapter and plugging it into a good AC source. If the battery is deeply discharged, it may take several cycles of charging and discharging for the battery to reach a maximum charge.
	Defective internal battery or internal problem with the ventilator.	Immediately contact a certified Pulmonetic Systems' service technician.
Battery Charge Status LED is flashing amber.	Internal battery charging.	The Charge Status LED flashes amber while the battery charging circuit evaluates the battery as a part of the charge cycle. If the battery is found to be OK, the Charge Status LED will change to solid amber while the battery is charging. The internal battery charges any time the ventilator is connected to an external power source. If the battery is deeply discharged, the Charge Status LED may flash amber for up to an hour.
	Defective internal battery or internal problem with the ventilator.	Immediately contact a certified Pulmonetic Systems' service technician.
Battery Charge Status LED is flashing red.	Defective internal battery or internal problem with the ventilator.	Immediately contact a certified Pulmonetic Systems' service technician.
Battery Charge Status LED is solid red.	Defective internal battery or internal problem with the ventilator.	Immediately contact a certified Pulmonetic Systems' service technician.

Alarms

Many alarms such as **HIGH PRES** or **LOW O2 PRES** can occur during normal operation. Information on addressing alarms is covered in the LTV® Series ventilator Operator's Manual. Single occurrences of some alarms, such as **HW FAULT** or **RESET** may be caused by ESD. If these alarms reoccur, and for other alarms that do not usually occur during normal operation, follow the instructions in this section or immediately contact Pulmonetic Systems.

Symptoms	Possible Causes	What to Do
HIGH PRES occurred but alarm did not sound.	Alarm silence was already active (Silence/Reset LED is red).	The ventilator alarms can be silenced for 60 seconds by pushing the Silence Reset button. If the alarm is already silenced (Silence/Reset LED is red), it will not sound again until the silence period expires.
	High pressure alarm delay is on - HP DELAY is set to DELAY 1 BRTH or DELAY 2 BRTH .	When a high pressure condition is detected, the HIGH PRES message is displayed and the High Pres Limit control is flashed. If the HP DELAY option is set to NO DELAY , the audible alarm is sounded immediately. When the HP DELAY option is set to DELAY 1 BRTH or DELAY 2 BRTH , the audible is not sounded until the second or third consecutive breath with a high pressure condition. (See page 10-4 for an explanation of HP DELAY .)
	Alarm automatically silenced after 3 seconds because condition cleared.	When an alarm occurs, the audible alarms sound for a minimum of 3 seconds or for as long as the condition exists. Some alarms, such as HIGH PRES may clear almost immediately and the alarm will sound for only 3 seconds.
Alarm doesn't sound.	Internal problem with the ventilator.	Immediately contact a certified Pulmonetic Systems' service technician.
Ventilator won't exhale, repeated HIGH PRES alarms, turbine stops and pressure drops, then autcycles up to HIGH PRES again.	Diaphragm installed backwards or incorrectly seated in exhalation valve.	Open the exhalation valve and remove the diaphragm and spring. Reseat the spring and diaphragm valve and snap the peep valve or peepless valve cap back in place. See page 13-10 for a diagram of correct exhalation valve assembly.

Symptoms	Possible Causes	What to Do
continued... <i>Ventilator won't exhale, repeated HIGH PRES alarms, turbine stops and pressure drops, then autocycles up to HIGH PRES again.</i>	Sense lines occluded or pinched.	Check high and low pressure sense lines to be sure they are correctly attached and securely seated at both the ventilator and wye ends. Verify lines are not occluded or pinched.
	Internal problem with the ventilator.	Immediately contact a certified Pulmonetic Systems' service technician.
Repeated DISC/SENSE alarms.	High or low side sense lines disconnected from vent or wye. High or low side sense line or elbow at patient wye loose or leaking. High or low sense lines are occluded. High or low sense ports in the wye are occluded.	Check high and low pressure sense lines to be sure they are correctly attached and securely seated at both the ventilator and wye ends. Check the luer fitting connections for leaks. Check the elbow connectors at the wye to be sure they have not loosened or been broken loose. Verify lines are not occluded or pinched. Check the exhalation drive line at both the ventilator and exhalation valve ends. Verify the line is securely seated and not leaking.
	Circuit disconnected from patient, wye or vent. Exhalation valve disconnected from wye. PEEP valve or peepless cap disconnected from wye.	Check the circuit and exhalation valve to verify the circuit is securely connected and the valve is intact. Open the exhalation valve and remove the diaphragm and spring. Reseat the spring and diaphragm valve and snap the peep valve or peepless valve cap back in place. See page 13-10 for a diagram of correct exhalation valve assembly.
	Pressure Control or Pressure Support set below PEEP.	Verify the control values are appropriately set.

Symptoms	Possible Causes	What to Do
continued... <i>Repeated DISC/SENSE alarms.</i>	Exhalation drive line leaking or loose. Exhalation valve leaking during inspiration.	Check the exhalation drive line at both the ventilator and exhalation valve ends. Verify the line is securely seated and not leaking. Verify the exhalation valve is not leaking during inspiration. If it is leaking, open the exhalation valve and remove the diaphragm and spring. Reseat the spring and diaphragm valve and snap the peep valve back in place. See page 13-10 for a diagram of correct exhalation valve assembly. If necessary, replace the exhalation diaphragm, PEEP spring or exhalation valve with a new one.
	Internal problem with the ventilator.	Immediately contact a certified Pulmonetic Systems' service technician.
Repeated XDCR FAULT alarms.	Internal problem with the ventilator.	Immediately contact a certified Pulmonetic Systems' service technician.
HW FAULT alarm	Electro static discharge (ESD).	Clear the alarm. Reduce static causing conditions in the operating environment.
	Fan was bumped or temporarily stopped while cleaning fan filter.	Clear the alarm. No further action required if alarm does not reoccur.
	Internal problem with the ventilator.	If problem reoccurs, immediately contact a certified Pulmonetic Systems' service technician.
RESET alarm occurs after ventilator is operated on internal battery until it is fully depleted.	Internal battery depleted.	This is a normal. Clear the alarm and charge the internal battery (see page 14-11 for instructions on charging the internal battery).
RESET, CRC, STACK, POST, or RUNAWAY alarms	Electro static discharge (ESD).	Clear the alarm. Reduce static causing conditions in the operating environment.
	Internal problem with the ventilator.	If problem reoccurs, immediately contact a certified Pulmonetic Systems' service technician.
NO CAL DATA alarm. NO CAL displayed in place of monitored values.	Failed or missing calibration records.	Immediately contact a certified Pulmonetic Systems' service technician.

Symptoms	Possible Causes	What to Do
DEFAULTS alarm. Event Log shows DEFAULTS .	Electro static discharge (ESD).	Some or all control settings were found to be invalid or out of range on power up and were restored to the default settings. Clear the alarm. Reduce static causing conditions in the operating environment.
	Internal problem with the ventilator.	If problem reoccurs, immediately contact a certified Pulmonetic Systems' service technician.
Repeated HIGH f alarms.	Total Breath Rate (f) exceeds the set HIGH f alarm values.	Check HIGH f alarm values. See page 10-5 for instructions.
	Patient Circuit leak, causing autocycling.	Do a Leak test and reseal or replace the leaking parts or connections. See page 11-8 for instructions.
	Internal problem with the ventilator.	If problem reoccurs, immediately contact a certified Pulmonetic Systems' service technician.
Repeated HIGH PEEP alarms.	Monitored PEEP exceeds the set HIGH PEEP alarm value.	Check HIGH PEEP alarm value. See page 10-5 for instructions.
	Patient Circuit, Exhalation valve and/or PEEP valve occluded.	Disassemble, clean and reassemble the Patient Circuit, Exhalation Valve and PEEP Valve. See page 13-6 for instructions.
	Internal problem with the ventilator.	If problem reoccurs, immediately contact a certified Pulmonetic Systems' service technician.
Remote Alarm System does not work with the ventilator.	Defective or improper connections.	Check the Remote Alarm cable connection between the ventilator's Patient Assist Port and the Remote Alarm System. See page C-16 for instructions.
	Defective Remote Alarm cable.	Replace Remote Alarm cable. See page C-16 for instructions.
	Defective Remote Alarm System.	Contact Remote Alarm System manufacturer or service personnel.
	Internal problem with the ventilator.	Immediately contact a certified Pulmonetic Systems' service technician.
Remote Alarm System (<i>single</i> tone system) generates a pulsating tone and manufacturers instructions indicate it should be a continuous tone.	PNT ASSIST option set to PULSE.	Set PNT ASSIST option to NORMAL. See page 10-5 for instructions.
	Defective Remote Alarm System.	Contact Remote Alarm System manufacturer or service personnel.
	Internal problem with the ventilator.	Immediately contact a certified Pulmonetic Systems' service technician.

Symptoms	Possible Causes	What to Do
Remote Alarm System (<i>dual</i> tone system) only generates one continuous tone.	PNT ASSIST option set to NORMAL.	Set PNT ASSIST option to PULSE. See page 10-6 for instructions.
	Defective Remote Alarm System.	Contact Remote Alarm System manufacturer or service personnel.
	Internal problem with the ventilator.	Immediately contact a certified Pulmonetic Systems' service technician.
Patient Assist Call System does not work with the ventilator.	Incorrect Patient Assist cable installed (Normally Open versus Normally Closed system/cable mismatch)	Establish whether the Patient Assist Call System is a Normally Open or Normally Closed system and verify the appropriate Patient Assist Cable (Normally Open or Normally Closed) is installed. See page C-14 for instructions.
	Defective or improper connections.	Check the Patient Assist Cable connection between the ventilator's Patient Assist Port and the Patient Assist Call System. See page C-14 for instructions.
	Defective Patient Assist cable.	Replace Patient Assist Cable.
	Defective Patient Assist Call System.	Contact Patient Assist Call System manufacturer or service personnel.
	Internal problem with the ventilator.	Immediately contact a certified Pulmonetic Systems' service technician.
Patient Assist Call System generates a pulsating tone or light and manufacturers instructions indicate it should be a continuous tone or light.	PNT ASSIST option set to PULSE.	Set PNT ASSIST option to NORMAL. See page 10-6 for instructions.
	Defective Patient Assist Call System.	Contact Patient Assist Call System manufacturer or service personnel.
	Internal problem with the ventilator.	Immediately contact a certified Pulmonetic Systems' service technician.

Checkout Test Failures

Symptoms	Possible Causes	What to Do
Alarm Test Audible alarm level excessive.	Alarm volume set too high.	Set the alarm volume under the Extended Features Menu. (See page 10-3 for an explanation of the ALARM VOL feature.)
Alarm Test Audible alarm too soft.	Alarm volume set too low.	Set the alarm volume under the Extended Features Menu. (See page 10-3 for an explanation of the ALARM VOL feature.)
	Alarm sounder blocked.	Check the alarm sounder opening in the right side of the ventilator to verify the opening is not blocked.
	Internal problem with the ventilator.	Immediately contact a certified Pulmonetic Systems' service technician.
Alarm Test Alarm does not sound.	Alarm sounder blocked.	Check the alarm sounder opening in the right side of the ventilator to verify the opening is not blocked.
	Internal problem with the ventilator.	Immediately contact a certified Pulmonetic Systems' service technician.
Alarm Test Confirming audible chirp does not sound ⁷² .	Ventilator back panel label does not contain an audio sound symbol (🎵).	This is normal. Ventilators that do not have an audio sound symbol (🎵) on the back panel label do not contain the confirming audible chirp feature.
	Audible alarm did not sound long enough before test was terminated.	Repeat the Alarm Test and allow audible alarm to sound for at least 2 seconds before pushing the Select button. (See <i>Chapter 11 - Alarm Test</i> for instructions.)
	Internal problem with the ventilator.	Immediately contact a certified Pulmonetic Systems' service technician.
Display Test A display or LED fails to light.	Internal problem with the ventilator.	Immediately contact a certified Pulmonetic Systems' service technician.
Control Test Correct message is not displayed when rotary switch is turned, or incorrect message is displayed.	Internal problem with the ventilator.	Immediately contact a certified Pulmonetic Systems' service technician.

⁷² Only applicable on ventilators with an audio sound symbol (🎵) on the back panel label.

Symptoms	Possible Causes	What to Do
Control Test Volume / Pressure Mode button, Pressure Control button, O ₂ % (O ₂ Flush) button, or Low Pressure O ₂ Source button do not display message when pushed.	Wrong model selected in maintenance mode.	Immediately contact a certified Pulmonetic Systems' service technician.
Leak Test Leak test fails.	Circuit connections or accessories are leaking. Wye is not properly capped.	Reseat or replace the leaking circuit parts, accessories or connections. Verify the wye is securely capped.
	Internal problem with the ventilator.	Immediately contact a certified Pulmonetic Systems' service technician.
Leak Test Leak test fails with LEAK --- FAIL message.	Internal problem with the turbine.	Immediately contact a certified Pulmonetic Systems' service technician.
Vent Inop Alarm Test Audible alarm too soft.	Alarm sounder blocked.	Check the alarm sounder opening in the right side of the ventilator to verify the opening is not blocked.
	Internal problem with the ventilator.	Immediately contact a certified Pulmonetic Systems' service technician.
Vent Inop Alarm Test Alarm does not sound.	Alarm sounder blocked.	Check the alarm sounder opening in the right side of the ventilator to verify the opening is not blocked.
	Internal problem with the ventilator.	Immediately contact a certified Pulmonetic Systems' service technician.
Vent Inop Alarm Test The Vent Inop LED is not illuminated.	Internal problem with the ventilator.	Immediately contact a certified Pulmonetic Systems' service technician.
Vent Inop Alarm Test Confirming audible chirp does not sound ⁷³ .	Ventilator back panel label does not contain an audio sound symbol (🎵).	This is normal. Ventilators that do not have an audio sound symbol (🎵) on the back panel label do not contain the confirming audible chirp feature.
	Audible alarm did not sound long enough before test was terminated.	Repeat the Vent Inop Alarm Test and allow audible alarm to sound for at least 15 seconds before pushing the Silence/Reset button. (See <i>Chapter 11 - Vent Inop Alarm Test</i> for instructions.)
	Internal problem with the ventilator.	Immediately contact a certified Pulmonetic Systems' service technician.

⁷³ Only applicable on ventilators with an audio sound symbol (🎵) on the back panel label.

Test Lung Operations

Symptoms	Possible Causes	What to Do
Delivered pressure higher than set pressure on test lung.	Pressure > 40 cmH ₂ O used on small test lung (Pulmonetic Systems or Siemens 190.)	The compliance characteristics of some small test lungs (Pulmonetic Systems or Siemens 190) cause incorrect readings when high pressures are used. For these lungs, use pressures under 40 cmH ₂ O or change to a larger lung.
Monitored volumes very high on test lung.	Test lung with small aperture connected directly to wye.	Some test lungs have a narrow opening or a restrictor, which may cause jetting and cause the flow differential to be read incorrectly. To reduce the jetting effect, add a short extension between the test lung and the wye.
	Very small ET tube connected directly to wye.	A very small ET tube connected directly to the wye may cause jetting and cause the flow differential to be read incorrectly. To reduce the jetting effect, add a short larger bore extension between the ET tube and the wye.

Appendix A - VENTILATOR SPECIFICATIONS

Modes and Breath Types

Breath Types	Volume Control, Pressure Control, Pressure Support, Spontaneous
Modes	Control, Assist/Control, SIMV, CPAP, NPPV, Apnea Backup

Variable Controls

<i>Control</i>	<i>Range</i>	<i>Tolerance</i>
Backup Pressure Trigger	-3 cmH ₂ O	± 2 cmH ₂ O
Breath Rate	"--", 1 to 80 bpm	± 1 bpm or 10% of breath period, whichever is less
Date Format	mm/dd/yyyy, dd/mm/yyyy, yyyy/mm/dd	n/a
Display Select	Toggles between manual or automatic display scrolling and changes monitor displayed.	n/a
Inspiratory/Expiratory Hold	One push toggles monitor window display between normal display, INSP HOLD and EXP HOLD. While INSP HOLD is displayed, a push and hold initiates an Inspiratory Hold. While EXP HOLD is displayed, a push and hold initiates an Expiratory Hold.	6 seconds maximum 6 seconds maximum
Inspiratory Time	0.3 to 9.9 seconds	± 0.05 seconds
Leak Compensation	On, Off	n/a
Language	English, Dansk, Deutsch, Español, Francais, Italiano, Norsk, Portugues, Svenska, Pyccko	n/a
O ₂ %	21% to 100%	O ₂ % mean: 21% to 50%: ± 3 51% to 100%: ± 5 keep steady-state only
(O ₂ Flush)	O ₂ : 95% Time: 1, 2, or 3 minutes	± 5 ± 0.1 sec
PIP LED Display	On, Off	n/a

<i>Control</i>	<i>Range</i>	<i>Tolerance</i>
Pressure Control	1 to 99 cmH ₂ O	± 2 cmH ₂ O or 8% whichever is greater, steady-state only
Pressure Control Flow Termination	On, Off	n/a
Pressure Support	"--", 1 to 60 cmH ₂ O	± 2 cmH ₂ O or 8% whichever is greater, steady-state only.
Set Date	01/01/1998 to 12/31/2097	n/a
Set Time	00:00:00 to 23:59:59	n/a
Sensitivity	1 to 9 Lpm, "-"	+ 1/- 0.5 lpm for setting of 1; ± 1 lpm for all other settings.
Tidal Volume	50 to 2000 ml	± 10% or 10 ml, whichever is greater for temperatures from 20°C to 30°C only, standard atmospheric pressure
Variable Flow Termination	10% to 40%	± 15% or 2 lpm whichever is greater
Variable Rise Time	1 to 9	0.1 to 1.0 sec
Variable Time Termination	0.3 to 3.0 sec	± 0.1 sec
Bias Flow	10 lpm during exhalation	± 10% or 1 lpm, whichever is greater

Alarms

Variable Alarms

<i>Control</i>	<i>Range</i>	<i>Tolerance</i>
Apnea Interval	10 to 60 seconds	± 0.5 seconds
High Breath Rate	Rate: 5 - 80 bpm - HIGH f OFF Time: 0 - 60 sec	± 1 bpm or within 5% of breath period, whichever is greater. ± 0.1 seconds
High PEEP	3 - 40 cmH ₂ O - HI PEEP OFF	± 2 cmH ₂ O or ± 10%, whichever is greater.
High Pressure Limit	5 to 100 cmH ₂ O	5 to 20 cmH ₂ O: ± 2 cmH ₂ O 21 to 100 cmH ₂ O: ± 4 cmH ₂ O
HP Alarm Delay	No Delay, 1 Breath, 2 Breaths	Only audible portion of alarm notification is delayed.
Low Minute Volume	0.1 to 99 liters	± 15% or the measured total breath rate times 15 ml, whichever is greater.
Low Peak Pressure	"- -", 1 to 60 cmH ₂ O	2 to 20 cmH ₂ O: ± 2 cmH ₂ O 21 to 60 cmH ₂ O: ± 4 cmH ₂ O
LPP Alarm	All Breaths, VC/PC Only	Select breath types Low Pressure alarm applies to.

Fixed Alarms

<i>Control</i>	<i>Range</i>	<i>Tolerance / Indicators</i>	
Default Settings	EEPROM problem detected	n/a	
DISC/SENSE (Low Pressure Sense Line Disconnect)	Positive (exhaled) airway flow during first 200 ms of inspiration and exhaled tidal volume (V _{te}) of previous breath is more than 4000 ml	n/a	
DISC/SENSE (High Pressure Sense Line Disconnect)	Airway pressure changes by ≤ 1 cmH ₂ O during 200 ms after inspiratory start OR After initial 200 ms of inspiration airway pressure drops below 0.125 cmH ₂ O and can't be raised more than 0.5 cmH ₂ O in next 500 ms	± 0.5 cmH ₂ O n/a	
External Power Lost	<9.5 V	± 2%	
Hardware Fault	Hardware problem detected	n/a	
Internal Battery Empty	< 11.5 V	± 2%	Battery Level LED Red and full volume audible alarm.
Internal Battery Low	< 11.9 V	± 2%	Battery Level LED Amber
Oxygen Inlet Pres. High	High pres source: 85 PSIG Low pres source: 10 PSIG	± 2 PSIG ± 1 PSIG	
Oxygen Inlet Pres. Low	< 35 PSIG	± 2 PSIG	
Reset	Processor problem detected	n/a	
Transducer Fault	Autozero value outside manufacturer's specifications	n/a	

Volume

Alarm Volume	60 to 85 dBA at one meter	± 5 dBA
--------------	---------------------------	---------

Inop

Ventilator Inop	Immediately upon a Ventilator INOP condition, the audible indicator will begin sounding with a steady tone and the Vent INOP LED shall illuminate. Depressing the Alarm Silence/Reset button will silence the audible indicator.
-----------------	--

Mechanical Controls

<i>Control</i>	<i>Range</i>	<i>Tolerance</i>
Over Pressure Relief	≤ 120 cmH ₂ O	N/A
PEEP/CPAP	0 to 20 cmH ₂ O	Uncalibrated
Sub-Ambient Relief	Pressure Drop: ≤ 5 cmH ₂ O	at 50 lpm

Internal Compliance

Compliance	< 0.1 mL/cm
------------	---------------

Monitors

<i>Monitor</i>	<i>Range</i>	<i>Tolerance</i>
Calculated Peak Flow	10 to 100 lpm	2 lpm or $\pm 10\%$, whichever is greater
Exhaled Tidal Volume	0 to 4000 ml	$\pm 15\%$ or 15 ml, whichever is greater
I:E Ratio, Measured	99:1 and 1:99 Based on the measured inspiratory / exhalation times	Accuracy for times are ± 50 ms or 5%, whichever is greater
I:E Ratio, Calculated	1:99 to 4.0:1 based on set breath rate and inspiratory time	$\pm 5\%$
Mean Airway Pressure	0 to 99 cmH ₂ O	± 2 cmH ₂ O or 10%, whichever is greater
O ₂ Cylinder Duration	0 - 99 hours and 59 minutes	- 0 / + 40%
Peak Inspiratory Pressure	0 to 120 cmH ₂ O	± 2 cmH ₂ O or 5%, whichever is greater
PEEP	0 to 99 cmH ₂ O	± 2 cmH ₂ O or 10%, whichever is greater
Total Breath Rate	0 to 250 breaths per minute	± 1 bpm or within 5% of the breath period, whichever is greater
Total Minute Volume	0 to 99.9 liters	$\pm 15\%$, or the measured total breath rate times 15 ml, whichever is greater

Button Controls

<i>Display</i>	<i>Function</i>
Control Lock	Locks front panel controls, can be set to Easy or Hard unlocking
Manual Breath	Generates a machine breath
Standby / On	Puts ventilator in On or Standby state
Low Pressure O ₂ Source	Selects Low Pressure O ₂ Source
Silence / Reset	Silences and resets alarms

Displays

<i>Display</i>	<i>Range</i>	<i>Tolerance</i>
Airway Pressure	-10 to 108 cmH ₂ O	± 3 cmH ₂ O or 5%, whichever is greater
Display Window	12 characters	n/a
Patient Effort	Green LED	n/a
Vent Inop	Red LED	n/a
External Power	Amber / Green LED	n/a
Charge Status	Red / Amber / Green LED	n/a
Battery Level	Red / Amber / Green LED	n/a

Usage Meter

Usage Meter	1 to 139,000 hrs	Below 100 hrs: ± 10% Above 100 hrs: ± 5%
-------------	------------------	---

Packaging

Size	3" x 10" x 12" -OR- 3.25" x 10.5" x 13.5" with Protective Boots installed.
Weight	13.4 lbs -OR- 14.4 lbs with Protective Boots installed.

Sound Level

Sound Level	Shall not exceed 50 dBA (RMS) at one meter
-------------	--

Storage and Operating Conditions

<i>Specification</i>	<i>Tolerance</i>
<i>Storage</i> ⁷⁴	
Temperature	-20 to +60 degrees C
Humidity	10% to 95% Relative, non-condensing
<i>Operating</i>	
Temperature	+5 to +40 degrees C
Humidity	15% to 95% Relative, non-condensing
<i>Orientation</i>	
The ventilator functions within its performance specifications when operated in any orientation.	
<i>Inlet Air Filtration</i>	
The ventilator air filter is removable and cleanable by the operator. All filter materials are FDA compliant for breathing circuits and meet burn requirements for UL 94HB.	

⁷⁴ LTV® Ventilators stored at temperatures outside of the specified Operating Temperature range are to be allowed to stabilize to within the operating temperature range before turning the ventilator on.

Storage and Operating Conditions (cont.)

<i>Specification</i>	<i>Tolerance</i>
<i>Oxygen Inlet</i>	
DISS or NIST Connector Inlet Pressure Range ⁷⁵	40 to 80 PSIG ± 2 PSIG
Tapered Tubing Connector Inlet Pressure Range	0 to 10 PSIG ± 2 PSIG
<i>Shock and Vibration</i>	
The ventilator is designed to withstand shock and vibration in accordance with relevant requirements set forth in the following standards:	
IEC 68-2-27	Shock
IEC 68-2-6	Vibration
IEC 68-2-34	Vibration
MIL-STD-810E	Shock, Ground Transport and Helicopter Transport Vibration
<i>Spillage</i>	
The ventilator resists fluid spillage when tested in accordance with the relevant standards specified in IEC 601-1 Clause 44.3.	
<i>External Surface Temperature</i>	
External surfaces	< 50°C, ambient temperature of 35°C n/a

Communications

<i>Port</i>	<i>Connector</i>	<i>Specification</i>
Communications	RS232, DB9 connector	Protocol Options: Data, Monitor, Printer, Modem
Patient Assist Call / Remote Alarm	RJ11-4	Closed contact resistance: ≤ 1 ohm

Equipment Classification

Classification	The ventilator is rated as Class II equipment per IEC 601-1 Clause 6.11
Type	The ventilator is specified as Type BF equipment per IEC 601-1 Clause 6.11

⁷⁵ Not applicable on LTV® 900 and 950

Power

<i>Feature</i>	<i>Range</i>	<i>Tolerance / Indicators</i>	
Input Voltage	11 to 15 VDC		
<i>External Power</i>			
AC Adapter	Input: 90 to 250 VAC, 47 to 63 Hz Output: 12.8 VDC	± 2.5%	
Full Power	Voltage ≥ 11.5 V	± 2%	Green LED
Low Power	Voltage < 11.0V and ≥ 9.5V	± 2%	Amber LED
External Power Off	Voltage < 9.5V	± 2%	LED off, switch to battery
Hysteresis	Ventilator shall not resume external power operation unless voltage is 11.5V	± 2%	
Nominal Current Draw	Startup: 5.5 amps Running: 3-4 amps		
Nominal Power Draw	Startup: 66 watts Running: 36 - 48 watts		
Leakage Current	Total leakage current to Earth ground for the ventilator with only approved accessories attached, shall not exceed 500 microAmps during normal operation, per IEC 601-1. Total leakage current to Earth ground for the ventilator shall not exceed one milliAmp when any single fault condition is present, per IEC 601-1.		
Ground Resistance	Total impedance between the ground contact at the inlet power connector and any accessible metal part shall not exceed 0.1 ohm, per IEC 601-1.		
Dielectric Strength	The ventilator shall be able to survive 1500 volts applied from either phase of the AC power inlet to Earth ground for a period of one minute, per IEC 601-1.		

Power (cont.)

Internal Battery

12V sealed lead acid battery. 4.5Ah.

<i>Feature</i>	<i>Range</i>	<i>Tolerance / Indicators</i>
Full Power	Green LED	
Medium Power	Amber LED	
Low Power	Red LED	
Charge Time	Battery shall be capable of being >90% charged within 8 hours, from fully discharged state to state indicated by green charge status LED.	When external power is present, and the vent is running at the nominal load
Charge Status	Pre-Charge Qualification: Battery Charging: Battery >90% Charged: Battery Fault:	Flashing Amber LED Amber LED Green LED Red LED
Hysteresis	Ventilator shall not resume battery operation unless the battery voltage level is 11.8 V.	± 2%

Battery Duration Time Before Ventilator Shutdown (total time):	60 minutes*	<u>Nominal Load Settings:</u>	
Approximate Time from battery full (green LED) to battery low (amber LED and BAT LOW alarm):	45 minutes*	Mode	A/C
Approximate Time from battery low to battery empty (red LED and BAT EMPTY alarm):	10 minutes*	PEEP	5
Approximate Time from battery empty to "ventilator shutdown" (Vent Inop LED and INOP alarm):	5 minutes*	Breath Rate (bpm)	15
		O ₂ %	21
		Tidal Volume (ml)	800
		Lung Compliance (ml/cmH ₂ O)	50
		Insp. Time (sec)	1.5
		ET Resistance (cmH ₂ O/L/S)	5.87
		Sensitivity (lpm)	2
		Battery Temp.	25 °C
* Times based on nominal load, new battery and full 8 hour battery charge.			
DOT Requirements: Unregulated, meets the requirements of 49 CFR 173, 159 (d).			

Agency Requirements

Regulatory Requirements

FDA Draft Reviewer Guidance for Ventilators, July, 1995.

Shipping Requirements

The ventilator, packed in its shipping container, conforms to the International Safe Transit Association requirements for packaged products weighing less than 100 pounds.

Appendix B - SET UP / MAINTENANCE

Recommended Maintenance Schedule

The LTV® Series ventilator is designed to operate for extended periods of time with minimal routine maintenance. The following periodic maintenance is recommended:

Hours of Service ⁷⁶	Maintenance Required
Prior to initial use	<ul style="list-style-type: none"> Charge the Internal Battery by plugging the ventilator into an AC power source for 24 hours. Setup the ventilator/accessories per <i>Appendix C - Installation and Checkout</i>. Check the ventilator for proper operation per <i>Appendix C - Installation and Checkout</i>
While in storage, every two months	<ul style="list-style-type: none"> Recharge the Internal Battery by plugging the ventilator into an AC power source for 24 hours⁷⁷.
Daily	<ul style="list-style-type: none"> Check the Inlet Filter, clean if necessary. Check the Fan Filter, clean if necessary.
If in use, a minimum of once a month	<ul style="list-style-type: none"> Check the ventilator per <i>Chapter 11 – Ventilator Checkout test</i>. While the ventilator is off-patient, perform the Power (external) disconnect test* Verify Vte or VE monitor * Verify airway pressure or PIP monitor * Verify delivered O2 concentration if not using an oxygen analyzer continuously. * (LTV1000 only, see <i>Appendix A – Ventilator Specifications</i> for accuracy tolerances).
*Use existing patient settings or example settings as shown in <i>Appendix C – Installation and Checkout</i>	
Every 10,000 hours or two years ⁷⁸	<ul style="list-style-type: none"> Replace the Internal Battery⁷⁹ only with Pulmonetic Systems battery P/N 10140⁸⁰ Calibrate the Transducers. Replace the Motor Board. Clean or replace the Interior Air Inlet Filter. Clean or replace the O₂ Inlet Filter.
Every 30,000 hours or six years, whichever comes first ⁷⁸	<ul style="list-style-type: none"> Replace the Turbine Manifold Assembly. Replace the Solenoid Manifold. Replace the Flow Valve. Replace the Rotary Knob Assembly. Replace the O₂ Blender. Replace the Fan Assembly. Replace all Silicone Tubing. Check the Thermo Pads for compression and replace if necessary.

⁷⁶ To check the number of hours the ventilator has been in service, see *Chapter 10 - Extended Features, Usage Meter*.

⁷⁷ If the battery is deeply discharged, it may take several charge and discharge cycles before it can be fully charged.

⁷⁸ 10,000 hour, two year and/or 30,000 hour, six year Extended Maintenance and ventilator repair must be performed by a Pulmonetic Systems factory trained service technician.

⁷⁹ Replacement at 10,000 hours or 2 years is based on normal use of up to 200 charge cycles. The battery may need to be replaced more frequently if it is being charged more often. The battery should also be replaced any time it fails to reach a full charge, or if the ventilator runs for less than ½ hour on a fully charged battery.

⁸⁰ The LTV® Internal Battery (P/N 10140) is contained in LTV® Internal Battery Replacement Kit, P/N 11636.

Service Assistance

For assistance in servicing the LTV® Series ventilator, contact a certified Pulmonetic Systems' service technician, or:

Pulmonetic Systems, Inc.

17400 Medina Rd., Suite 100

Minneapolis, Minnesota 55447-1341

Phone: (763) 398-8300

Customer Care Center: (800) 754-1914

Fax: (763) 398-8400

E-mail: info@pulmonetic.com

Website: <http://www.pulmonetic.com>

Appendix C - INSTALLATION AND CHECKOUT

Installation and Setup

Unpacking the Ventilator - Instructions

- 1) Inspect the exterior of the ventilator transport container for evidence of damage during transit. If present, notify the delivering service.
- 2) Take the ventilator and all accessories out of the transport container.
- 3) Confirm the presence of all items listed on the packing slip. Notify a authorized sales representative or Pulmonetic Systems of any discrepancies.
- 4) Examine all components for visible damage. If present, notify the delivering service.
- 5) Retain the transport container for potential ventilator service or maintenance returns.

Protective Boots

Rubberized protective boots are installed on the top and bottom of all current versions of LTV® ventilators to protect them from accidental shocks and strikes to the casing. If desired, they may be removed and/or re-installed using the following instructions.

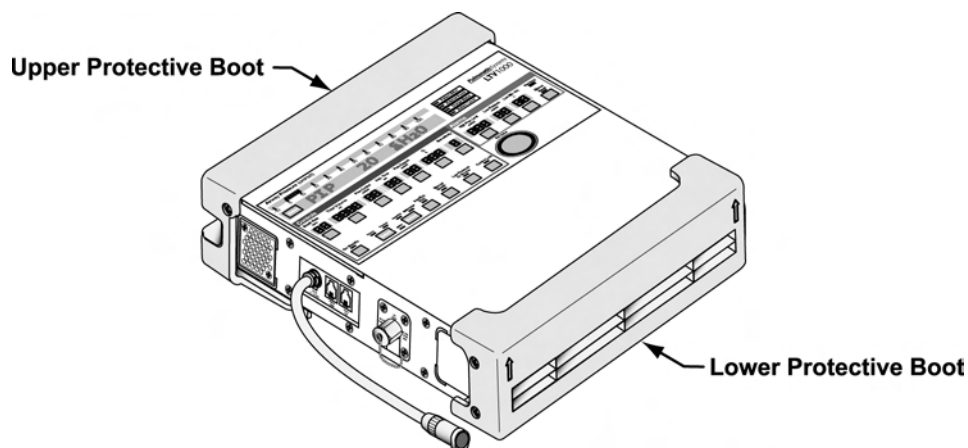

WARNING

Mounting Screw Use – Internal damage to the ventilator may result if the wrong length mounting screws are used when installing or removing external accessories.

Accessories Mounting Screws - Refer to the information contained in Pulmonetic Systems Replacement Screws Kit, P/N 11149, to determine the appropriate mounting screws or replacement screws location, type and length to use when removing or exchanging external accessories on an LTV® Series ventilator.

AVERTISSEMENT

Utilisation des vis de montage – Vous pourriez causer des dommages internes au ventilateur si des vis de montage de mauvaise longueur sont utilisées lors de l'installation ou de la dépose des accessoires externes.

Vis de montage des accessoires – Voir les renseignements fournis dans la trousse de vis de remplacement de Pulmonetic Systems, numéro de pièce 11149, pour déterminer l'emplacement, le type et la longueur des vis de montage d'accessoires ou des vis de remplacement pour accessoires à utiliser lors de la dépose ou de l'échange d'accessoires externes sur un ventilateur de la série LTV®.

Protective Boot Removal

Supplies/Tools Required:

- Replacement Screws Kit, P/N 11149
- Torque wrench (20 in-oz / 0.14 Nm to 60 in-oz / 0.42 Nm range)
- Phillips-head screwdriver

To Remove the Upper Protective Boot⁸¹:

- 1) Carefully place and support the disconnected ventilator in an upright position on a clean, dry surface.
- 2) **Prior to removing the mounting screws**, refer to the illustration and make note of where the screw is located in the leg of the upper boot (upper or lower hole).

WARNING

Specific Boot Replacement Screw Location - One leg of the upper protective boot has an additional screw hole (furthest from the end of the leg);

- On earlier version ventilators (screw was located in the upper hole in the leg of the boot) the use of a 3/16" mounting screw is required.
- On current version ventilators (screw was located in the lower hole in the leg of the boot) the use of a 1/4" mounting screw is required.

AVERTISSEMENT

Emplacement des vis de remplacement d'un gaine spécifique – Une patte de la gaine protectrice supérieure possède un trou de vis supplémentaire (le plus éloigné de l'extrémité de la patte);

- Sur les anciennes versions des ventilateurs (la vis se trouvait dans le trou supérieur de la patte de la gaine), vous devez utiliser une vis de montage de 3/16".
- Sur la version actuelle des ventilateurs (la vis se trouve dans le trou inférieur de la patte de la gaine), vous devez utiliser une vis de montage de 1/4".

- 3) Using a Phillips screwdriver, remove the two flat-head mounting screws and finish washers in the legs of the upper boot (①) and the two flat-head mounting screws and finish washers in the sides of the upper boot, as indicated in the illustration on the next page.
- 4) Remove the upper boot and insert and thread two #4-40 pan-head mounting screws into the screw holes in the ventilator's back panel, as indicated in the illustration.
 - Earlier version ventilators (screw was aligned with the upper hole in the boot) require the use of the 3/16" pan-head mounting screw (③).
 - Current version ventilators (screw was aligned with the lower hole in the boot) require the use of the 1/4" pan-head mounting screw (④).
- 5) Insert and thread two #4-40 X 1/4" flat-head mounting screws (⑤) with finish washers (⑥) into the screw holes in the ventilator's side panels, as indicated in the illustration.

⁸¹ Refer to Appendix C for information concerning the appropriate accessories mounting screws or accessories replacement screws location, type and length to use when removing or exchanging external accessories on an LTV® Series ventilator.

- Finish washers (Ⓞ) should be already in place.
- 6) Torque tighten the mounting screws to these specified values (do not over tighten to avoid damage to the finish washers);
- Torque tighten the screws in the back panel of the ventilator to **60 in-oz** (0.42 Nm)
 - Torque tighten the screws in the sides of the ventilator to **20 in-oz** (0.14 Nm)

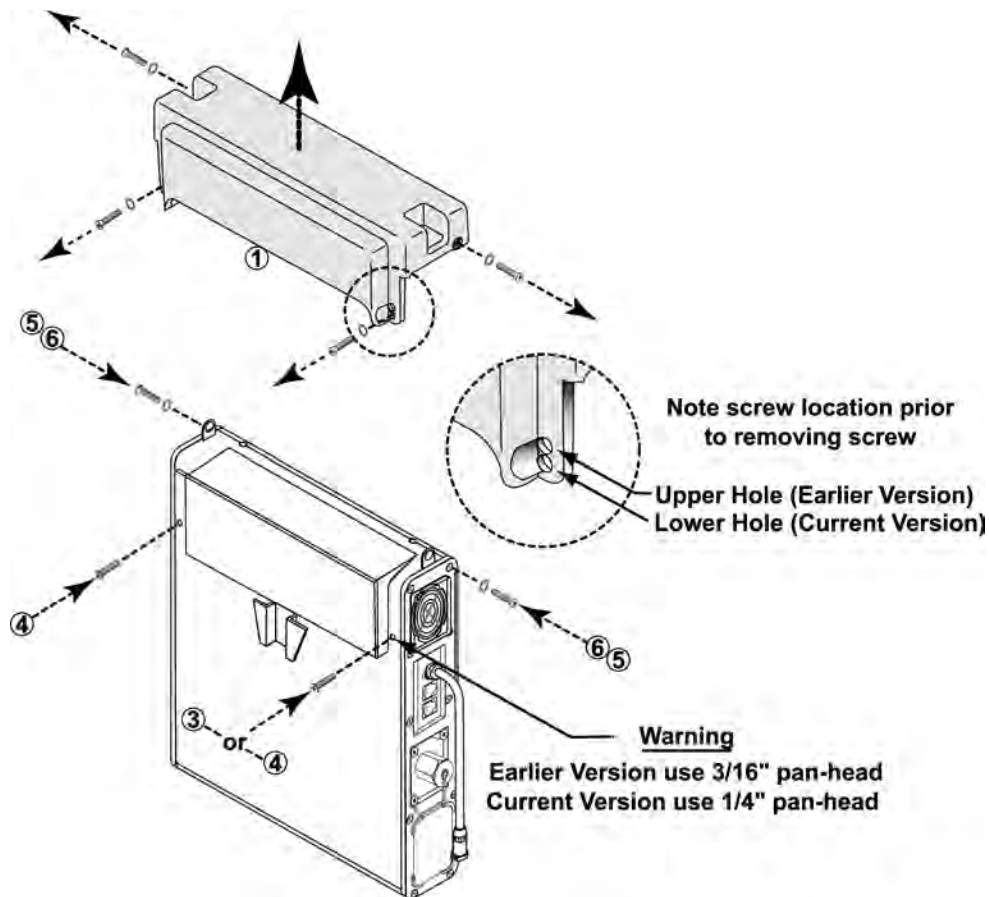

- Item ①, Protective Boot, Upper (1), P/N 11421
- Item ②, Protective Boot, Lower (1), P/N 11420
- Item ③, #4-40 X 3/16" Pan-head screw (1), P/N 10438⁸²
- Item ④, #4-40 X 1/4" Pan-head mounting screws (2), P/N 10435⁸²
- Item ⑤, #4-40 X 1/4" Flat-head mounting screws (6), P/N 10430⁸²
- Item ⑥, Finish Washers (6), P/N 10191⁸²

⁸² Contained in Pulmonetic Systems Replacement Screws kit, P/N 11149.

To Remove the Lower Protective Boot⁸³:

- 1) Lay the ventilator down (front up) and use a Phillips-head screwdriver to remove the four flat-head mounting screws and finish washers in the sides of the lower protective boot (②), as indicated in the illustration.
- 2) Remove the lower boot (②) and insert and thread four #4-40 X 1/4" flat-head mounting screws (⑤) with finish washers (⑥) into the screw holes in the ventilator's side panels, as indicated in the illustration.
 - Finish washers (⑥) should be already in place.
- 3) Torque tighten all four screws to **20 in-oz** (0.14 Nm) (do not over tighten to avoid damage to the finish washers).

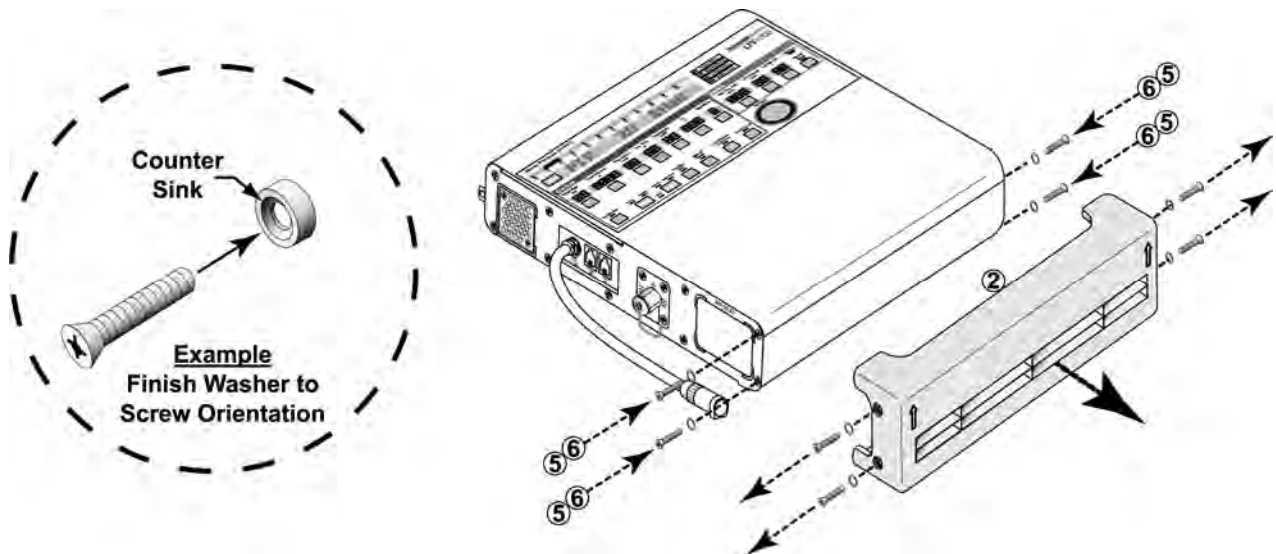

- Item ①, Protective Boot, Upper (1), P/N 11421
- Item ②, Protective Boot, Lower (1), P/N 11420
- Item ③, #4-40 X 3/16" Pan-head screw (1), P/N 10438⁸⁴
- Item ④, #4-40 X 1/4" Pan-head mounting screws (2), P/N 10435⁸²
- Item ⑤, #4-40 X 1/4" Flat-head mounting screws (6), P/N 10430⁸²
- Item ⑥, Finish Washers (6), P/N 10191⁸²

⁸³ Refer to Appendix C for information concerning the appropriate accessories mounting screws or accessories replacement screws location, type and length to use when removing or exchanging external accessories on an LTV® Series ventilator.

⁸⁴ Contained in Pulmonetic Systems Replacement Screws kit, P/N 11149.

Protective Boot Installation

Supplies/Tools Required:

- Item ①, Protective Boot, Upper (1) P/N 11421
- Item ②, Protective Boot, Lower (1) P/N 11420
- Replacement Screws Kit, P/N 11149
- Torque wrench (20 in-oz / 0.14 Nm to 60 in-oz / 0.42 Nm range)
- Phillips-head screwdriver

To Install the Upper Protective Boot⁸⁵:

- 1) Carefully place and support the disconnected ventilator in an upright position on a clean, dry surface.
- 2) Using a Phillips-head screwdriver, remove the two upper back panel pan-head and two side panel flat-head mounting screws indicated in the illustration.
 - Do not remove the mating finish washers.
- 3) Orient the upper protective boot (①) over the ventilator as shown in the illustration (next page). Move the boot down into position on the top of the ventilator and align its four screw holes with the corresponding holes in the ventilator back and side panels.
- 4) Insert and thread two #4-40 flat-head mounting screws with finish washers ② through the screw holes in the legs of the upper boot, as indicated in the illustration (next page).



WARNING

Specific Boot Installation Screw Location - One leg of the upper protective boot has an additional screw hole (furthest from the end of the leg);

- On earlier version ventilators, the screw hole will align with the upper hole in the boot and requires the use of the 1/4" mounting screw.
- On current version ventilators, the screw hole will align with the lower hole in the boot and requires the use of the 3/8" mounting screw.



AVERTISSEMENT

Emplacement des vis d'installation d'un gaine spécifique – Une patte de la gaine protectrice supérieure possède un trou de vis supplémentaire (le plus éloigné de l'extrémité de la patte);

- Sur les anciennes versions des ventilateurs, le trou de la vis s'alignera au trou supérieur de la gaine et vous devez utiliser une vis de montage de 1/4".
- Sur la version actuelle des ventilateurs, le trou de la vis s'alignera au trou inférieur de la gaine et vous devez utiliser une vis de montage de 3/8".

⁸⁵ Refer to page C-9 for information concerning the appropriate accessories mounting screws or accessories replacement screws location, type and length to use when removing or exchanging external accessories on an LTV® Series ventilator.

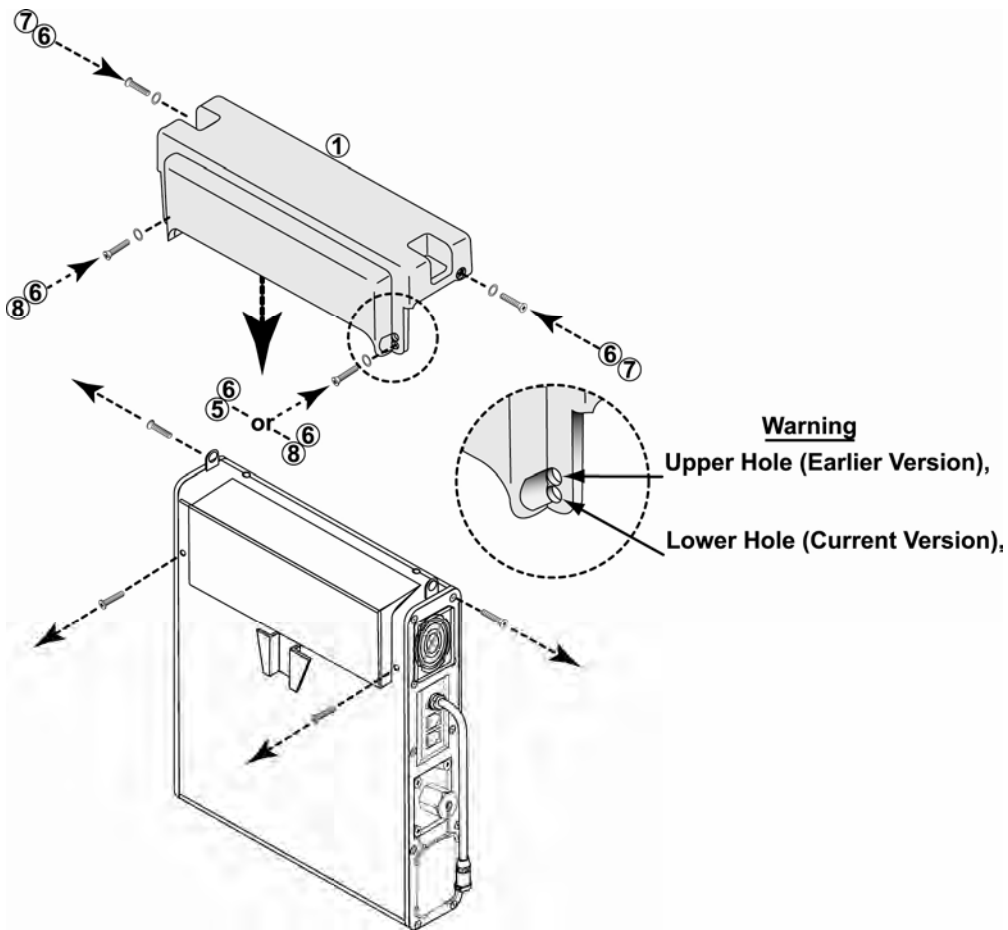

- Item ⑤, #4-40 X 1/4" Flat-head mounting screw (1) P/N 10430⁸⁶
- Item ⑥, Finish Washers (8) P/N 10191⁸⁶
- Item ⑦, #4-40 X 1/2" Flat-head mounting screws (6) P/N 10338⁸⁶
- Item ⑧, #4-40 X 3/8" Flat-head mounting screws (2) P/N 10474⁸⁶

- 5) Insert and thread two #4-40 X 1/2" flat-head mounting screws ⑦ with finish washers ⑥ through the screw holes in the sides of the upper boot, as indicated in the illustration.
- 6) Torque tighten the mounting screws to these specified values (do not over tighten to avoid damage to the finish washers).
 - Torque tighten the screws in the legs of the boot to **60 in-oz** (0.42 Nm)
 - Torque tighten the screws in the sides of the boot to **20 in-oz** (0.14 Nm)

⁸⁶ Contained in Pulmonetic Systems Replacement Screws kit, P/N 11149.

To Install the Lower Protective Boot⁸⁷:

- 1) Lay the ventilator down (front up) and use a Phillips-head screwdriver to remove the four flat-head mounting screws in the ventilator's side panels, as indicated in the illustration.
 - Do not remove the mating finish washers.
- 2) Orient the lower protective boot ② to the ventilator as shown in the illustration. Move the boot into position on the bottom of the ventilator and align its four screw holes with the corresponding holes in the ventilator side panels.
 - Ensure the orientation arrows on the bottom of the boot are aligned up, as shown.
- 4) Insert and thread four #4-40 X 1/2" flat-head mounting screws ⑦ with finish washers ⑥ through the screw holes in the sides of the lower boot; as indicated in the illustration below.
- 5) Torque tighten all four screws in the boot to **20 in-oz** (0.14 Nm) (do not over tighten to avoid damage to the finish washers).

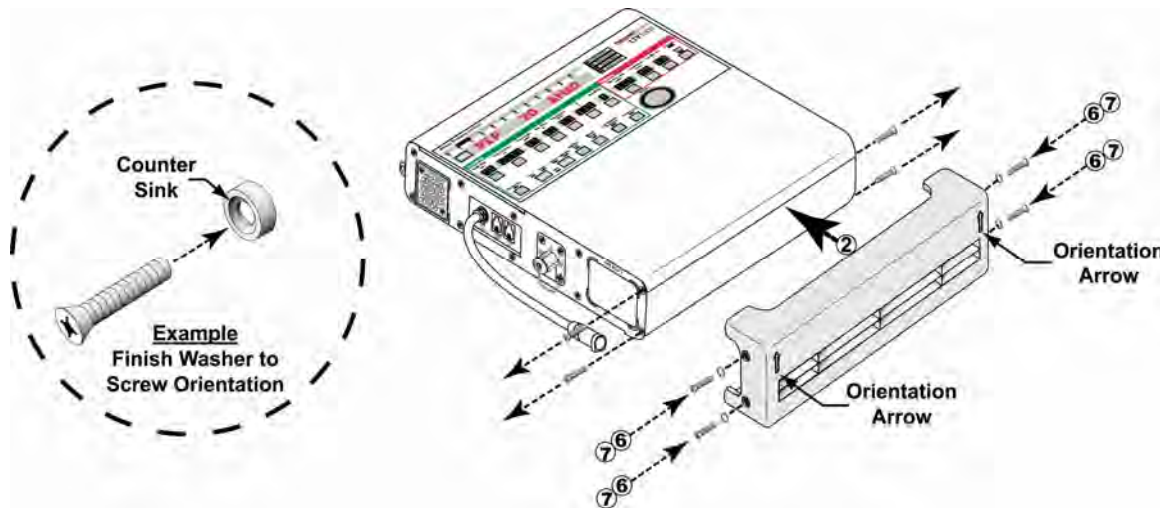

- Item ⑤, #4-40 X 1/4" Flat-head mounting screw (1) P/N 10430⁸⁶
- Item ⑥, Finish Washers (8) P/N 10191⁸⁶
- Item ⑦, #4-40 X 1/2" Flat-head mounting screws (6) P/N 10338⁸⁸
- Item ⑧, #4-40 X 3/8" Flat-head mounting screws (2) P/N 10474⁸⁶

⁸⁷ Refer to page C-9 for information concerning the appropriate accessories mounting screws or accessories replacement screws location, type and length to use when removing or exchanging external accessories on an LTV® Series ventilator.

⁸⁸ Contained in Pulmonetic Systems Replacement Screws kit, P/N 11149.

LTV External Accessories Mounting Screws Location, Type & Length

(Reference Pulmonetic Systems Replacement Screws Kit, P/N 11149)

LTV Ventilator Final Configuration Desired	Screw Location	Qty	Screw Description	Washer Used
Ventilator, with no external accessories installed.	①	3	1/4" Flat-head	None
	②	6	1/4" Flat-head	Finish-washer
	③	2	1/4" Pan-head	None
	④	1	3/16" Pan-head	None
Ventilator, with LTV/LTM Mounting Bracket installed	①	3	3/8" Pan-head	None
	②	6	1/4" Flat-head	Finish-washer
	③	2	3/8" Pan-head	None
	④	1	5/16" Pan-head	None
Ventilator, with Protective Boots installed (Ref. P/N 11509 for installation instructions)	①	3	1/4" Flat-head	None
	②	6	1/2" Flat-head	Finish-washer
	③	2	3/8" Flat-head	Finish-washer
	④	1	1/4" Flat-head	Finish-washer

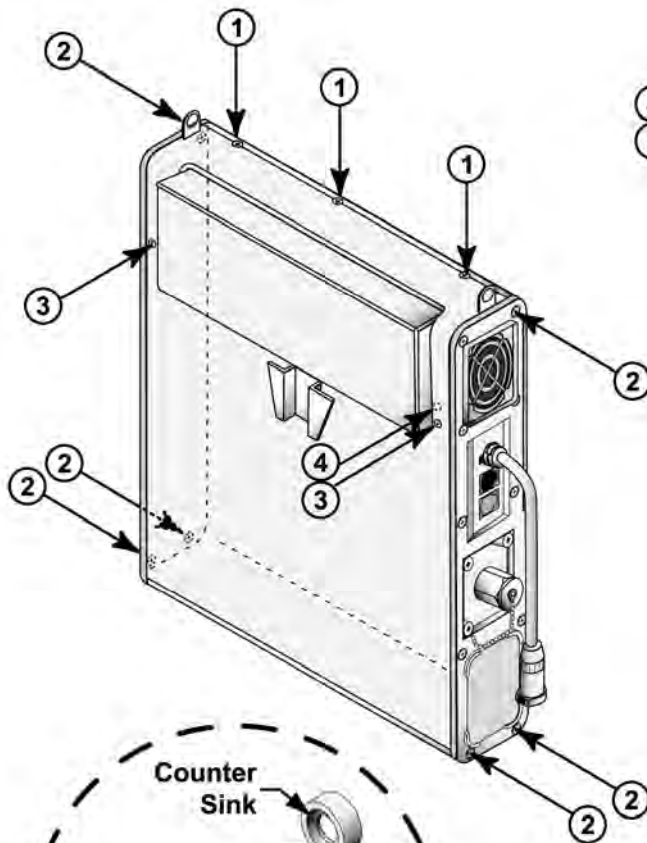

④ - Earlier version LTV ventilator screw location
 ③ - Current version LTV ventilator screw location

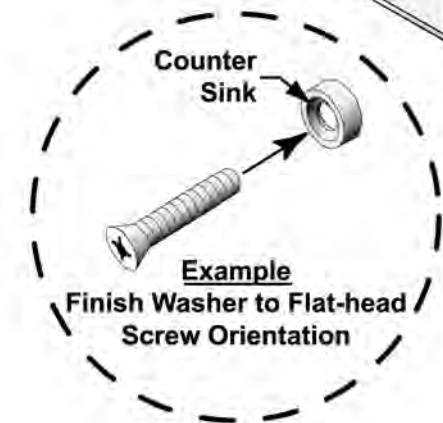
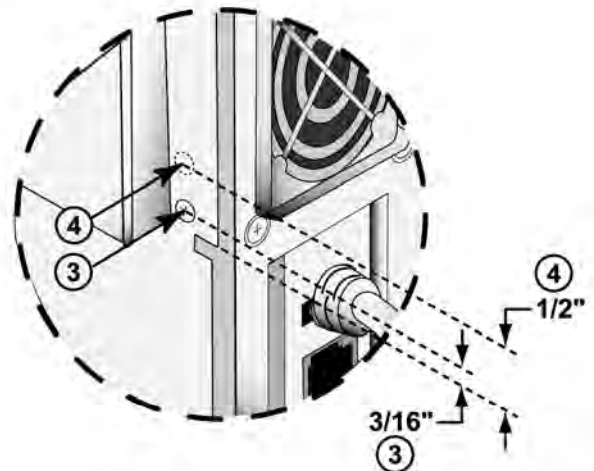

Screw Type/Scale	
Pan-head	Flat-head
3/16"	1/4"
1/4"	3/8"
5/16"	1/2"
3/8"	

(screws shown actual size)

Patient Breathing Circuit – Connection Instructions

- 1) Connect the main breathing tube to the 22 mm outlet port on the right side of the ventilator.
- 2) Connect the two exhalation flow transducer sense lines to the ports marked **Flow Xducer** on the right side of the ventilator. These are non-interchangeable Luer fittings.
- 3) Connect the exhalation valve drive line to the port marked **Exh Valve** on the right side of the ventilator.

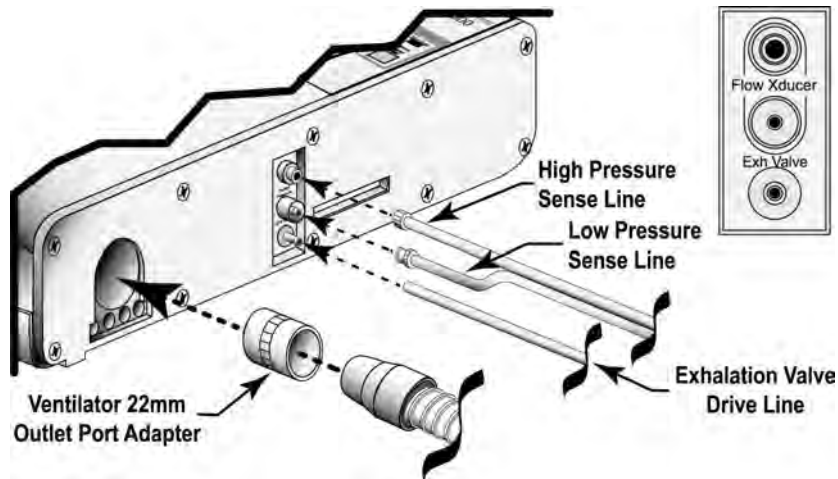

CAUTION

Patient Wye Installation – After cleaning, install the patient wye in the patient circuit so the proximal sense lines are oriented up while operating.

ATTENTION

Installation de la soupape d'expiration - Après le nettoyage, installez la soupape d'expiration dans le circuit du patient de sorte que les lignes de détection soient alignées vers le haut pendant l'opération.

Ventilator without Humidifier

- 1) Connect the main breathing tube to the 22mm outlet port on the right side of the ventilator.

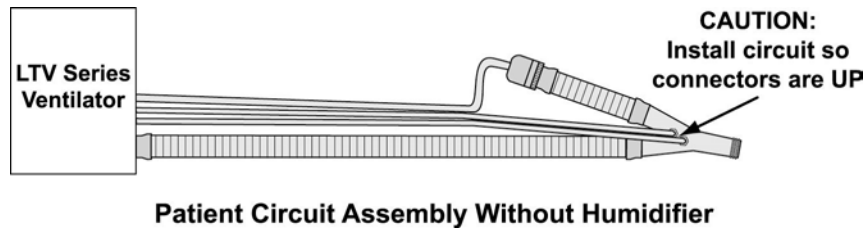

- 2) Connect the two exhalation flow transducer sense lines to the ports marked Flow Xdcer on the right side of the ventilator. These are non-interchangeable Luer fittings.
- 3) Connect the exhalation valve drive line to the port marked Exhl Valve on the right side of the ventilator.

Ventilator with Humidifier

- 1) Attach the main breathing tube to the outlet port on the humidifier.
- 2) Connect the humidifier circuit tube (*not included in reusable circuit configurations*) to the 22mm outlet port on the right side of the ventilator and to the inlet port of the humidifier.

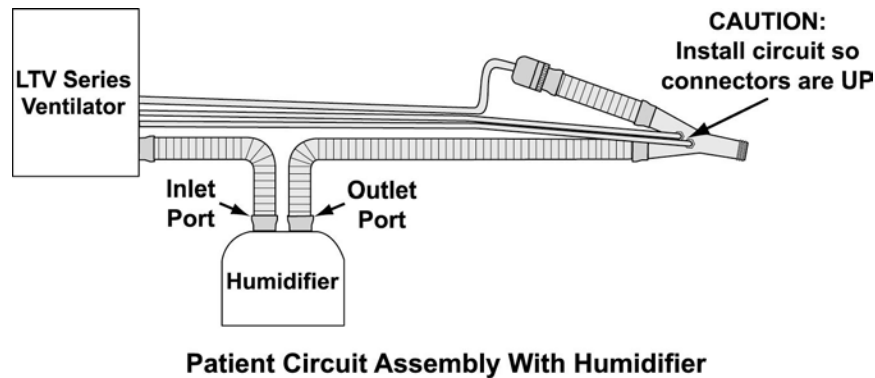

- 3) Connect the two exhalation flow transducer sense lines to the ports marked Flow Xdcer on the right side of the ventilator. These are non-interchangeable luer fittings.
- 4) Connect the exhalation valve driveline to the port marked Exhl Valve on the right side of the ventilator.

 **WARNING**

Disabled Oxygen Inlet Pressure Alarms - When the oxygen blending option is not installed, the Oxygen Inlet Pressure Alarms are disabled.

 **AVERTISSEMENT**

Alarmes de pression d'entrée de l'oxygène désactivées - Lorsque l'option de mélange d'oxygène n'est pas activée, les alarmes de pression d'entrée de l'oxygène sont désactivées.

CAUTION

Oxygen Supply Contamination - The accuracy of the oxygen delivery capabilities of LTV[®] ventilators can be compromised by foreign debris contamination in the oxygen supply system. To reduce the risk of airborne contaminants entering the ventilator, ensure that any oxygen supply connected to the ventilator is clean, properly filtered⁸⁹ and that the ventilator's O2 Inlet Port Cap is securely installed on the O2 Inlet Port whenever the ventilator is not connected to an external oxygen supply.

ATTENTION

Contamination de la réserve d'oxygène — La précision de la capacité d'alimentation en oxygène des ventilateurs LTV[®] peut être compromise par la présence de corps étrangers dans le système d'alimentation en oxygène. Afin de diminuer le risque de présence d'agents contaminants atmosphériques dans le ventilateur, assurez-vous que la réserve d'oxygène reliée au ventilateur est propre et filtrée de manière adéquate⁸⁹, et que le bouchon de l'orifice d'alimentation en oxygène est correctement installé à chaque fois que le ventilateur n'est pas relié à une source d'oxygène externe.

⁸⁹ In addition to the existing internal O₂ Inlet filter, P/N 14313, an External, In-Line Oxygen Filter (P/N 14470) is available from Pulmonetic Systems, Inc.

For Operation from a High Pressure Oxygen Source (LTV 1000 only):

To operate from a high pressure (40 - 80 PSIG) oxygen source, connect an oxygen hose to the female DISS⁹⁰ oxygen inlet fitting labeled **O2 INLET** on the left side of the ventilator.

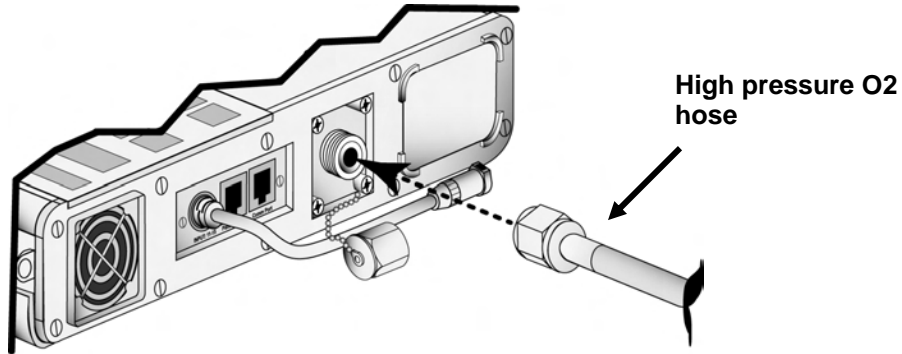

For Operation from a Low Pressure Oxygen Source:

For operation from a low pressure oxygen source such as an oxygen concentrator, attach the low pressure adapter to the inlet fitting labeled **O2 INLET** located on the left side of the ventilator. Then attach the oxygen supply line to the hose barb on the adapter.

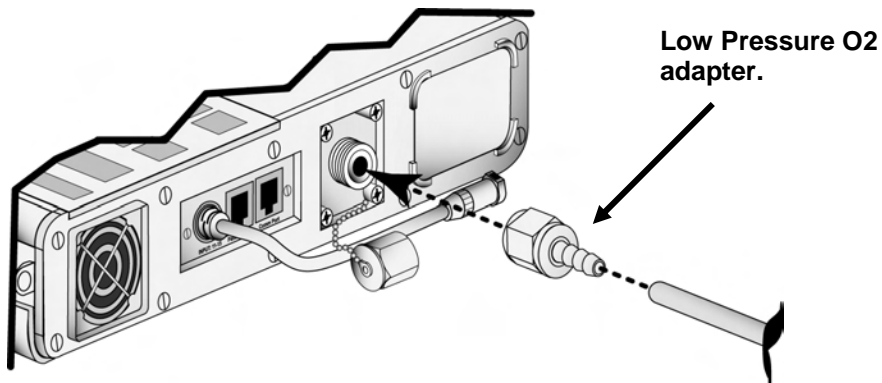

⁹⁰ An NIST adapter for this connection P/N 10702 is available from Pulmonetic Systems upon request.

Patient Assist Call System – Connection Instructions

The ventilator is configured to interface with a Patient Assist Call system requiring either normally-closed or normally-open contact sets.

- If your patient assist system is Normally Open, use *Patient Assist Cable, Normally Open* P/N 10780.
- If your patient assist system is Normally Closed, use *Patient Assist Cable, Normally Closed* P/N 10779.

To connect the ventilator to the patient assist system:

- 1) Insert the telephone jack connector (RJ11-4) into the port labeled **PATIENT ASSIST** on the left hand side of the ventilator.
- 2) Connect the jack on the other end of the cable to your patient assist system.

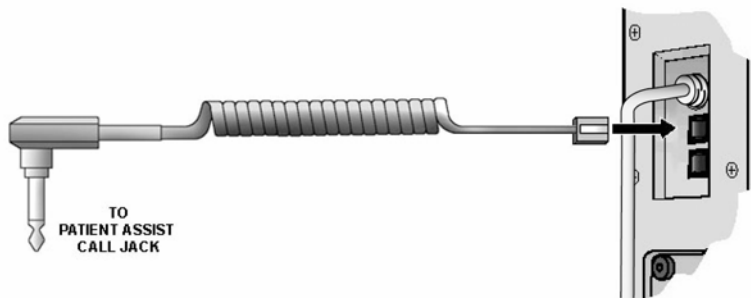

- 3) Test the connection by performing an Alarm test (see *Chapter 11 - Ventilator Checkout Tests*) or by causing an alarm and verifying the patient assist call activates.

⚠ WARNING

Unapproved Adapters – Only Pulmonetic Systems Accessories should be used to connect the ventilator to Patient Assist Call Systems. These accessories incorporate safety features to reduce the risk of shock. Do not attempt to modify these accessories in any way.

Patient Assist Call Connector – Do not apply more than 25V rms or 32VDC to the Patient Assist Call connector.

⚠ AVERTISSEMENT

Accessoires non approuvés – L'utilisation d'accessoires qui ne sont pas expressément approuvés par Pulmonetic Systems pourrait entraîner des conditions dangereuses. Seuls les accessoires de Pulmonetic Systems devraient être utilisés pour brancher les ventilateurs aux systèmes d'aide aux patients. Ces accessoires comportent des caractéristiques de sécurité pour réduire les risques de choc. N'essayez pas de modifier ces accessoires d'aucune façon.

Connecteur d'appel d'aide aux patients – Ne mettez pas plus de 25 V efficace ou 32 V c.c. au connecteur d'appel d'aide aux patients.

Communications Port

The Communications Port on the LTV® Series ventilator allows for attachment to, and communication with, accessories such as graphics monitors or printers. Currently the printer option is only available for use by service personnel.

Use the Communications Setting option in the Extended Features menu to modify the communications protocol (see *Chapter 10 - Extended Features, Communications Setting* for instructions).

LTM™ Graphics Monitor

The LTM™ Graphics Monitor is a thin, lightweight color graphics monitor accessory for LTM compatible⁹¹ LTV® 900, 950 and 1000 ventilators.

- To upgrade an LTV® Series ventilator to LTM Graphics Monitor compatibility, a certified Pulmonetic Systems' service technician must replace both the internal Analog PCBA and Memory PCBA with LTM compatible components.
- For additional information regarding the LTM Graphics Monitor, contact Pulmonetic Systems.

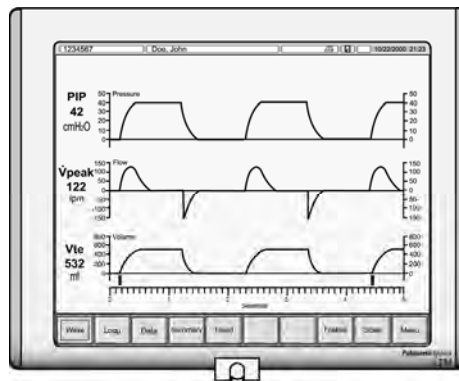

To install and setup an LTM Graphics Monitor, refer to the *LTM Graphics Monitor Operator's Manual* included with your LTM Graphics Monitor.

⁹¹ LTM Graphics Monitor compatibility can be verified by pushing the Select button when the **LTV Model Number** is displayed in the Extended Features menu. The message **LTM** will be displayed if the ventilator was originally manufactured or upgraded by Pulmonetic Systems to accommodate the LTM Graphics Monitor.

Using the Remote Alarm Cable

Use the Remote Alarm Cable (P/N 10893) to connect the LTV[®] Series ventilator to third party, single or dual tone remote alarm systems requiring a normally closed input signal terminated with a 51K ohm series resistor.

- See *Chapter 10 - Extended Features, Alarm Operations*, for instructions on setting the Patient Assist Port output signal for use with single or dual tone remote alarm systems.

Because the LTV[®] Series ventilator does not include an internal series resistor in the Patient Assist output, a special cable has been designed which incorporates the resistor into the cable assembly itself. The series resistor allows the remote alarm to detect and report both ventilator alarms and a disconnected remote alarm cable.

CAUTION

Remote Alarm - Always verify that the remote alarm properly reports the LTV[®] Series ventilator alarms before use.

Remote Alarm - Always follow the remote alarm manufacturer's usage and maintenance requirements to guarantee proper function of the device.

ATTENTION

Alarme à distance – Assurez-vous toujours que l'alarme à distance indique de façon adéquate les alarmes du ventilateur LTV[®] avant d'utiliser le ventilateur.

Alarme à distance – Suivez toujours les exigences d'utilisation et d'entretien du fabricant de l'alarme à distance afin d'assurer le fonctionnement adéquat de l'appareil.

To connect the ventilator to the remote alarm:

- 1) Plug the cable's modular jack into the Patient Assist port on the side of the LTV[®] Series ventilator.
- 2) If the remote alarm has a female BNC plug, connect the cable directly to the remote alarm's input cable or connector and twist to secure.

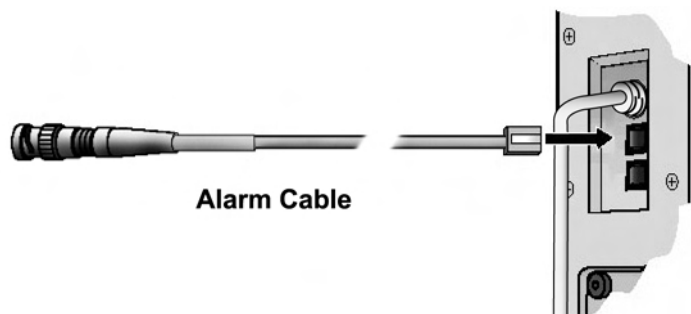

- 3) If the remote alarm has a male BNC plug, insert the included BNC adapter into the cable's connector and twist to secure. Then connect the adapter to the remote alarm's input cable or connector.

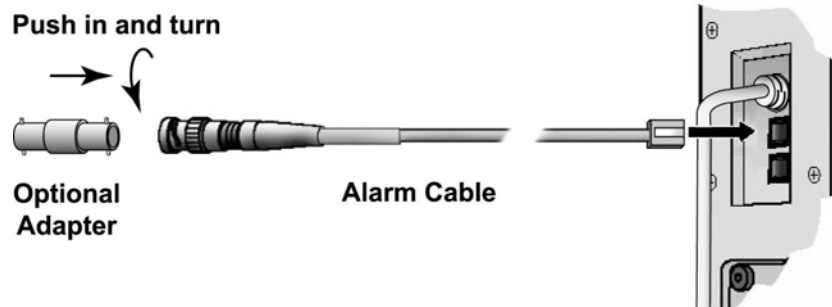

- 4) Create an alarm condition at the ventilator and verify that the remote alarm reflects the alarm state properly.
- 5) Clear the ventilator alarm condition and verify that the remote alarm reflects the alarm state properly.

Checking the Ventilator for Proper Operation

- 1) Verify that the ventilator is functioning properly by performing the Ventilator Checkout Tests.⁹²
 - Disconnect the patient from the ventilator and ventilate the patient using an alternative method before running the Ventilator Checkout tests.
- 2) Connect the AC adapter to a valid AC power source. Connect the patient circuit to the ventilator and to a test lung with a compliance of 10 ml/cmH₂O and a resistance of 5 cm/L/sec. Do not connect the Oxygen supply. Turn the ventilator on and proceed with the checkout as defined in the following table:

Ventilator Settings and Procedure	Performance Requirement
A) Configure the ventilator settings as follows, and run the equipment for at least two minutes: Mode: Volume, Assist/Ctrl Low Press O2: Off ⁹³ Breath Rate: 12 Tidal Volume: 500 Insp. Time: 1 sec Pressure Support: 0 ⁹⁴ O₂%: 21 ⁹³ Sensitivity: 3 High Pressure Limit: 100 Low Pressure Alarm: 5 Low Min Vol: 1.0 PEEP: Minimum	Selected Monitors should read as follows: <ul style="list-style-type: none"> • Exhaled Tidal Volume: 383 to 633 ml • I:E Ratio : 1:3.8 to 1:4.2 • Total Breath Rate: 12 bpm • Total Minute Vol: 4.6 to 7.6 L • No Alarms
B) Set the O ₂ % control to 22% (LTV [®] 1000 Only)	LOW O2 PRES alarm activates after a short pause
C) Reset O ₂ % to 21 and clear the alarm. Set the Low Min Vol Alarm to 10 L	LOW MIN VOL alarm activates
D) Reset the Low Min Vol Alarm to 1.0 and clear the alarm. Set the Low Pressure alarm to 60.	LOW PRES alarm activates
E) Set the Low Pressure Alarm to 5 and clear the alarm. Set the High Pres Limit to 10 cmH ₂ O below the Peak Inspiratory Pressure.	HIGH PRES alarm activates
F) Reset the High Pressure Limit alarm to 100 and clear the alarm.	
G) Connect 40 to 80 PSIG oxygen to the unit and set the O ₂ % control to	<ul style="list-style-type: none"> • External oxygen monitor should read 55 to 65% O₂

⁹² See Chapter 11 - Ventilator Checkout Tests for more information

⁹³ Oxygen source and tested O₂% only apply to the LTV[®] 1000.

⁹⁴ Not applicable to the LTV[®] 900.

Ventilator Settings and Procedure	Performance Requirement
60. Connect an external oxygen monitor to the patient circuit. (LTV® 1000 Only)	<ul style="list-style-type: none"> No alarms activate
H) Reset O ₂ % control to 21. (LTV® 1000 Only)	
I) Disconnect the high pressure sense line from the ventilator (see the illustration in <i>Appendix C - Patient Breathing Circuit – Connection Instructions</i>)	<ul style="list-style-type: none"> DISC/SENSE alarm activates on the next breath
J) Reconnect the high pressure sense line and clear the alarm	
K) Change control settings as follows: Mode: Pressure, Assist/Cntl Pressure Control: 40 PEEP: Max (LTV® 950 / 1000 Only)	Selected Monitors should read as follows: <ul style="list-style-type: none"> PIP: 36 to 44 cmH₂O PEEP: 17 to 23 cmH₂O No alarms activate
L) Disconnect AC Adapter from Ventilator at pigtail cable connector	<ul style="list-style-type: none"> POWER LOST alarm activates Battery Level LED illuminates showing the charge level Ventilator continues to operate from the internal battery

Ventilator Proper Operation Worksheet

SERIAL NUMBER: _____	CONDUCTED BY: _____
DATE: _____	

TEST DESCRIPTION	PAGE / STEP	MEAS. VALUE	REQUIREMENT	PASS / FAIL
------------------	-------------	-------------	-------------	-------------

Ventilator Checkout Tests (Chapter 11 -)

Alarm Test	11-3		Audible alarm must activate for minimum 2 sec's.	
			Confirming audible Chirp ⁹⁵ must activate after alarm is silenced	
Display Test	11-4		All displays must light except VENT INOP	
Control Test	11-6		Correct messages displayed in window	
Leak Test	11-8		"X.X PASS", Record value displayed	
Vent Inop Alarm Test	11-10		Alarm sounded and Inop LED illuminated 15 sec's.	
			Confirming audible Chirp ⁹⁵ must activate after alarm is silenced	

Checking the Ventilator for Proper Operation (Appendix C - Installation and Checkout):

Ventilator Settings:

Settings: Mode: Volume, Assist/Ctrl Low Press O₂: Off Breath Rate: 12 Tidal Volume: 500 Insp. Time: 1 sec O₂%: 21 Sensitivity: 3 High Pressure Limit: 100 Low Pressure Alarm: 5 Low Min Vol: 1.0 PEEP: Minimum	C-18 2) A)		Selected Monitors should read as follows:	
			Exhaled Tidal Volume: 383 to 633 ml	
			I:E Ratio : 1:3.8 to 1:4.2	
			Total Breath Rate: 12 bpm	
			Total Minute Vol: 4.6 to 7.6 L	
			No Alarms	

⁹⁵ Only applicable on ventilators with an audio sound symbol (🎵) on the back panel label.

Procedure:

Set the O ₂ % control to 22% (LTV® 1000 Only)	C-18 2) B)		LOW O2 PRES alarm activates after a short pause	
Reset O ₂ % to 21 and clear the alarm. Set the Low Min Vol Alarm to 10 L	C-18 2) C)		LOW MIN VOL alarm activates	
Reset the Low Min Vol Alarm to 1.0 and clear the alarm. Set the Low Pressure alarm to 60.	C-18 2) D)		LOW PRES alarm activates	
Set the Low Pressure Alarm to 5 and clear the alarm. Set the High Pres Limit to 10 cmH ₂ O below the Peak Inspiratory Pressure.	C-18 2) E)		HIGH PRES alarm activates.	
Reset the High Pressure Limit alarm to 100 and clear the alarm.	C-18 2) F)			
Connect 40 to 80 PSIG oxygen to the unit, and set the O ₂ % control to 60. Connect an external oxygen monitor to the patient circuit. (LTV® 1000 Only)	C-18 2) G)		External oxygen monitor should read 55 to 65% O ₂ .	
			No alarms activate.	
Reset O ₂ % control to 21. (LTV® 1000 Only)	C-19 2) H)			
Disconnect the high pressure sense line from the ventilator	C-19 2) I)		DISC/SENSE alarm activates on the next breath	
Reconnect the high pressure sense line and clear the alarm	C-19 2) J)			
Change control settings as follows: Mode: Pressure, Assist/Cntl Pressure Control: 40 PEEP: Max (LTV® 950 / 1000 Only)	C-19 2) K)		Selected Monitors should read as follows:	
			PIP: 36 to 44 cmH ₂ O	
			PEEP: 17 to 23 cmH ₂ O	
			No alarms activate	
Disconnect AC Adapter from Ventilator at pigtail cable connector.	C-19 2) L)		POWER LOST alarm activates	
			Battery Level LED illuminates showing the charge level.	
			Ventilator continues to operate from the internal battery	

Appendix D - PRINCIPLES OF OPERATION

Overview

The LTV® Series ventilator utilizes an electromechanical pneumatic system under the control of a microprocessor to deliver patient ventilation. The following diagram and description illustrates the major components of the ventilator and their respective functions.

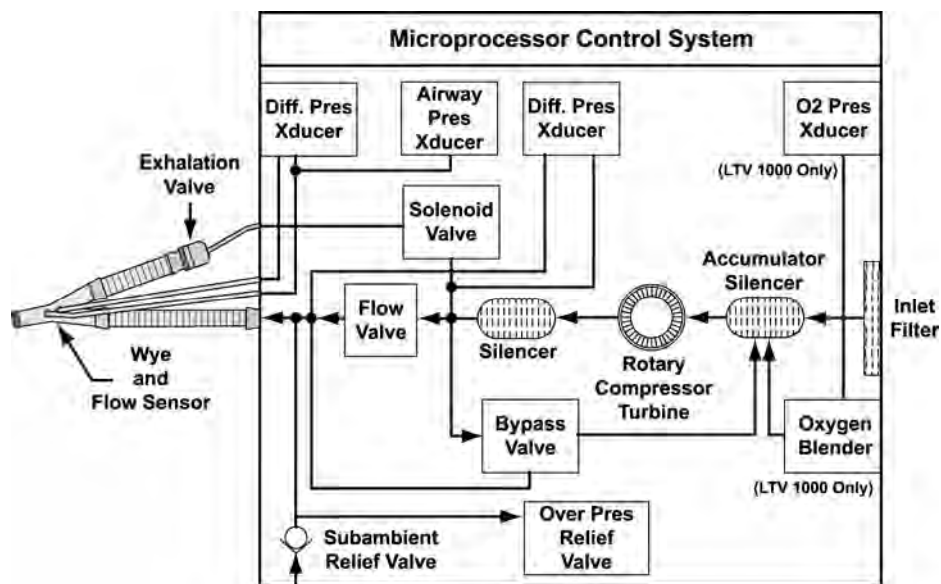

Room air enters the ventilator through a flexible foam **Inlet Filter**. After exiting the filter, the air enters an **Accumulator/Silencer** where it mixes with oxygen delivered from the **Oxygen Blender**. In addition, this chamber provides acoustic silencing to reduce the **Rotary Compressor** input noise. Mixed gas then enters the **Rotary Compressor**, where energy is added to the gas stream as required to meet the pressure and flow delivery requirements of the current ventilation settings.

Gas exiting the **Rotary Compressor** output port enters another **Silencer**. This chamber dampens acoustic noise from the **Rotary Compressor**. Upon exiting the silencing chamber, the gas flow splits in two paths. Gas flow for ventilation diverts to the **Flow Valve**, while excess flow is recirculated through the **Bypass Valve** to the inlet **Accumulator/Silencer**. The **Bypass Valve** maintains **Flow Valve** inlet pressure high enough above **Flow Valve** outlet pressure to ensure a positive differential pressure across the valve, yet low enough to ensure that excess energy is not wasted when operating from batteries.

Ventilation flow enters the **Flow Valve**, which controls all inspiratory gas flow to the patient. The valve is driven by a rotary actuator, and translates circular motion to a poppet position, which in turn meters flow to the patient. The valve is characterized such that gas flow is a known function of differential pressure across the valve and actuator position. A **Differential Pressure Transducer** is provided to measure the differential flow valve pressure.

Ventilation gas exiting the **Flow Valve** is connected to the **Exhalation Valve** by a patient circuit. The **Exhalation Valve** provides the following functions:

- 1) Closes the exhalation port during inspiration to divert gas to the patient.
- 2) Opens the exhalation port during exhalation to allow patient gases to be exhausted to the atmosphere.
- 3) Provides variable PEEP (Positive End Expiratory Pressure) during the exhalation phase.
- 4) Measures the exhaled flow using a fixed orifice type transducer. Transducer sensor ports are located between the patient and ventilator connection ports.

A **Differential Pressure Transducer** is provided to measure the delta pressure developed across the flow transducer. The transducer is autozeroed to ambient pressure and the sense lines are purged to prevent moisture migration into the transducer.

The **Oxygen Blender** accepts pressurized oxygen from an external source and as directed by the control system meters the oxygen flow to meet the requirements of the current O₂ % setting and ventilation flow demand. The **O₂ Pressure Transducer** measures inlet pressure and is used by the blender control system to compensate the oxygen delivery for variations in oxygen inlet pressure.

The **Sub-Ambient Relief Valve** allows the patient to inspire spontaneously from room air in the event of a failure of the main ventilator system. The **Over Pressure Relief Valve** provides an independent mechanical means to limit the maximum inspiratory pressure. Both of these functions are physically included in the Flow Valve Body.

The **Airway Pressure Transducer** measures pressure at the patient airway and is used for a feedback signal during the delivery of pressure breaths. The transducer is autozeroed to ambient pressure and the sense lines are purged to prevent moisture migration into the transducer.

Appendix E - EVENT TRACE

The Event Trace is a list of events recorded by the ventilator. These events may be normal conditions, such as turning the ventilator on or off, or alarm conditions such as **HW FAULT** or **HIGH PRES**.

- Initial occurrences of events are recorded the first time they occur after power up, along with the date, time and associated data, if any.
- A second occurrence of the same type of event (same event code) will be recorded as a separate line item along with the latest date, time and associated data. The quantity of occurrences is increased by one (1) (i.e. a quantity of two (2) will be displayed)).
- Additional occurrences (3rd or more) of the same type of event will update the secondary occurrence line items with the latest date, time, and associated data. The quantity of occurrences will be increased by one (1) for each additional occurrence (i.e. the quantity of 2 will be increased to 3).

NOTE

Event log entries are only one of many diagnostic tools used to troubleshoot the ventilator. Additional information is often required to accurately identify the root cause of a problem. See *Chapter 14 - Troubleshooting* for more information.

REMARQUE

Les entrées du journal d'événements ne représentent que l'un des nombreux outils de diagnostic utilisés pour localiser les pannes du ventilateur. Des informations supplémentaires sont souvent nécessaires pour identifier de façon précise la source d'un problème. Reportez-vous au *Chapitre 14 – Dépannage*, pour de plus amples informations.

To view the events:

- 1) Enter the Extended Features menu by pushing and holding the Select button for 3 seconds.
- 2) Turn the Set Value knob until **EVENT TRACE** is displayed.
- 3) Push the Select button while **EVENT TRACE** is displayed.
 - **xx:eventname** is displayed.
 - **xx** is the chronological number of the event occurrence.
 - **eventname** is the name of the event.
- 4) Push the Select button.
 - **xx:EyCz** is displayed.
 - **xx** is the chronological number of the event occurrence.
 - **y** is the event code number of the event.
 - **z** is the quantity of occurrences since power up⁹⁶ (for software versions 3.01 or earlier);

⁹⁶ The maximum number of occurrences recorded is 255.

- For software version 3.11, a quantity of 1 is displayed in the initial occurrence recordings and a quantity of 2 or more in the secondary occurrence recordings of the same type of event.
- 5) Push the Select button.
- **xx:eventdate** is displayed.
 - **xx** is the chronological number of the event occurrence.
 - **eventdate** is the date⁹⁷ of the first occurrence (for software versions 3.01 or earlier);
 - For software version 3.11, the date of the first occurrence is displayed in the initial occurrence recordings and the date of the latest occurrence in the secondary occurrence recordings of the same type of event.
- 6) Push the Select button.
- **xx:hh:mm:ss** is displayed.
 - **xx** is the chronological number of the event occurrence.
 - **hh:mm:ss** is the time of the first occurrence (for software versions 3.01 or earlier);
 - For software version 3.11, the time of the first occurrence is displayed in the initial occurrence recordings and the time of the latest occurrence in the secondary occurrence recordings of the same type of event.
- 7) Push the Select button.
- **xx:data** is displayed.
 - **xx** is the chronological number of the event occurrence.
 - **data** is the data associated with the first occurrence of this event (for software versions 3.01 or earlier);
 - For software version 3.11, the data associated with the first occurrence is displayed in the initial occurrence recordings and the data associated with the latest occurrence in the secondary occurrence recordings of the same type of event.
- For some events, the data field will be blank.
- 8) Push the Select button to return to the initial display.
- 9) Turn the Set Value knob clockwise or counterclockwise to view other events.
- 10) To exit the **EVENT TRACE**, turn to **EXIT** and push the Select button or push Control Lock.

For more information about how these codes are used, see the LTV[®] Series ventilator *Service Manual (P/N 10665)* or contact a certified Pulmonetic Systems' service technician.

⁹⁷ Date is displayed in the currently selected date format.

Event Codes

This section includes a list of the event codes that can be recorded in the Event Trace.

Event Codes by Code

Code	Event Name	Event	Associated Alarm
01	VENT 1	Power on	None
02	VENT 0	Power off	None
03	HOUR MTR	Set hour meter	None
04	VENT CHK	Set vent check	Entered VENT CHECK mode
05	APNEA 1	Apnea mode entered	APNEA
06	APNEA 0	Apnea mode exited	APNEA
07		N/A	
08	HIGH DIS	High side disconnect	DISC/SENSE
09	LOW DIS	Low side disconnect	DISC/SENSE
10	DISC 0	Circuit disconnect exited	DISC/SENSE
11	BATMPT1	Internal battery empty occurred	BAT EMPTY
12	BATMPT0	Internal battery empty exited	BAT EMPTY
13	BATLOW1	Internal battery low occurred	BAT LOW
14	BATLOW0	Internal battery low exited	BAT LOW
15	EXT LST1	External power lost occurred	POWER LOST
16	EXT LST0	External power lost exited	POWER LOST
17	EXT LOW1	External power low occurred	POWER LOW
18	EXT LOW0	External power low exited	POWER LOW
19	XDC FLT1	XDCR fault occurred	XDCR FAULT
20	XDC FLT0	XDCR fault exited	XDCR FAULT
21	O2 LOW 1	O ₂ pressure low occurred	LOW O2 PRES
22	O2 LOW 0	O ₂ pressure low exited	LOW O2 PRES
23	O2 HI 1	O ₂ pressure high occurred	HIGH O2 PRES
24	O2 HI 0	O ₂ pressure high exited	HIGH O2 PRES
25	DEFAULTS	Defaults, or Set Defaults occurred	DEFAULTS / DEFAULTS SET
26	NO CAL	No calibration data found	NO CAL DATA
27	FAN FLT1	Fan fault occurred	HW FAULT
28	FAN FLT0	Fan fault exited	HW FAULT
29		N/A	
30		N/A	
31	INTRRPT1	Spurious interrupt occurred ms	RESET
32	INTRRPT2	Spurious interrupt occurred ls	RESET
33	AD MMTCH	ADC mismatch	HW FAULT
34	AD MTCH1	ADC mismatch occurred	HW FAULT
35	AD MTCH0	ADC mismatch cleared	HW FAULT
36	SYNCER1	Stepper motor lost sync occurred	HW FAULT

Code	Event Name	Event	Associated Alarm
37	SYNCER0	Stepper motor lost sync exited	HW FAULT
38	HOME ER1	Stepper motor home failure occurred	HW FAULT
39	HOME ER0	Stepper motor home failure exited	HW FAULT
40	EEPROM	EEPROM degraded	HW FAULT
41	CRC	Memory CRC check failed	RESET
42	HI PRES1	High pressure occurred	HIGH PRES
43	HI PRES0	High pressure exited	HIGH PRES
44	TBN ISTOP	Turbine immediate stop occurred	HIGH PRES
45	TBN ZERO	Turbine set to zero flow occurred	HIGH PRES
46	TBN ESTP	Turbine emergency stop occurred	HIGH PRES
47	LOW VE 1	Low minute volume occurred	LOW MIN VOL
48	LOW VE 0	Low minute volume exited	LOW MIN VOL
49	LO PRES1	Low peak pressure occurred	LOW PRES
50	LO PRES0	Low peak pressure exited	LOW PRES
51	CLR EVNT	Event log cleared	N/A
52	CLR CTRL	Control settings cleared	N/A
53	SET DATE	Date set	N/A
54	SET TIME	Time set	N/A
55		N/A	
56	STACK	Stack overflow detected	RESET
57	POST	POST failure	RESET
58	RUNAWAY	Code runaway detected	RESET
59	WDOG TST	Watchdog test run	Inop
60	CLR CAL	Calibration records cleared	N/A
61	XDCR NAR	Differential pressure transducer - Narrow channel fault	XDC FLT1
62	XDCR WID	Differential pressure transducer - Wide channel fault	XDC FLT1
63	XDCR BI	Differential pressure transducer - Bi-directional channel fault	XDC FLT1
64	XDCR AIR	Airway pressure transducer fault	XDC FLT1
65	ADC1 VAL	AD mismatch primary channel fault value	HW FAULT
66	TBN HSTP	Turbine Hold Stop occurred	HIGH PRES
67	LN VENT1	Shutdown for other than pressing On/Standby button	RESET
68	FLUSH ER	A problem is detected writing data to the EEPROM during system shutdown.	HW FAULT
69	RAC ERR1	Problem detected with primary and/or redundant audible alarm circuitry	HW FAULT
70	RAC ERR0	Recovery from problem detected with primary and/or redundant audible alarm circuitry	HW FAULT
71	SNDRERR1	Alarm sounder error	HW FAULT

Code	Event Name	Event	Associated Alarm
72	SNDRERR0	Recovery from alarm sounder error	HW FAULT
73	HIGH f1	High breath rate alarm occurred	HIGH f
74	HIGH f0	High breath rate alarm recovered	HIGH f
75	HI PEEP1	High PEEP alarm occurred	HIGH PEEP
76	HI PEEP0	High PEEP alarm recovered	HIGH PEEP
77		N/A	
78		N/A	
79		N/A	
80		N/A	
81		N/A	
82		N/A	
83		N/A	
84		N/A	
85		N/A	
86		N/A	
87		N/A	
88	CLR BREC	Reclaims all incorrectly recognized bad EEPROM records	N/A

Event Codes by Event Name

Event Name	Code	Event	Associated Alarm
AD MMTCH	33	ADC mismatch	HW FAULT
AD MTCH0	35	ADC mismatch cleared	HW FAULT
AD MTCH1	34	ADC mismatch occurred	HW FAULT
ADC1 VAL	65	AD mismatch primary channel fault value	HW FAULT
APNEA 0	06	Apnea mode exited	APNEA
APNEA 1	05	Apnea mode entered	APNEA
BATLOW0	14	Internal battery low exited	BAT LOW
BATLOW1	13	Internal battery low occurred	BAT LOW
BATMPT0	12	Internal battery empty exited	BAT EMPTY
BATMPT1	11	Internal battery empty occurred	BAT EMPTY
CLR BREC	88	Reclaims all incorrectly recognized bad EEPROM records	N/A
CLR CAL	60	Calibration records cleared	N/A
CLR CTRL	52	Control settings cleared	N/A
CLR EVNT	51	Event log cleared	N/A
CRC	41	Memory CRC check failed	RESET
DEFAULTS	25	Defaults, or Set Defaults occurred	DEFAULTS / DEFAULTS, SET
DISC 0	10	Circuit disconnect exited	DISC/SENSE
EEPROM	40	EEPROM degraded	HW FAULT
EXT LOW0	18	External power low exited	POWER LOW
EXT LOW1	17	External power low occurred	POWER LOW
EXT LST0	16	External power lost exited	POWER LOST
EXT LST1	15	External power lost occurred	POWER LOST
FAN FLT0	28	Fan fault exited	HW FAULT
FAN FLT1	27	Fan fault occurred	HW FAULT
FLUSH ER	68	A problem is detected writing data to the EEPROM during system shutdown.	HW FAULT
HI PEEP0	76	High PEEP alarm recovered	HIGH PEEP
HI PEEP1	75	High PEEP alarm occurred	HIGH PEEP
HI PRES0	43	High pressure exited	HIGH PRES
HI PRES1	42	High pressure occurred	HIGH PRES
HIGH DIS	08	High side disconnect	DISC/SENSE
HIGH f0	74	High breath rate alarm recovered	HIGH f
HIGH f1	73	High breath rate alarm occurred	HIGH f
HOME ER0	39	Stepper motor home failure exited	HW FAULT
HOME ER1	38	Stepper motor home failure occurred	HW FAULT
HOURL MTR	03	Set hour meter	None
INTRRPT1	31	Spurious interrupt occurred ms	RESET
INTRRPT2	32	Spurious interrupt occurred ls	RESET
LN VENT1	67	Shutdown for other than pressing On/Standby	RESET

Event Name	Code	Event	Associated Alarm
LO PRES0	50	Low peak pressure exited	LOW PRES
LO PRES1	49	Low peak pressure occurred	LOW PRES
LOW DIS	09	Low side disconnect	DISC/SENSE
LOW VE 0	48	Low minute volume exited	LOW MIN VOL
LOW VE 1	47	Low minute volume occurred	LOW MIN VOL
NO CAL	26	No calibration data found	NO CAL DATA
O2 HI 0	24	O ₂ pressure high exited	HIGH O2 PRES
O2 HI 1	23	O ₂ pressure high occurred	HIGH O2 PRES
O2 LOW 0	22	O ₂ pressure low exited	LOW O2 PRES
O2 LOW 1	21	O ₂ pressure low occurred	LOW O2 PRES
POST	57	POST failure	RESET
RAC ERR0	70	Recovery from problem detected with primary and/or redundant audible alarm circuitry	HW FAULT
RAC ERR1	69	Problem detected with primary and/or redundant audible alarm circuitry	HW FAULT
RUNAWAY	58	Code runaway detected	RESET
SET DATE	53	Date set	N/A
SET TIME	54	Time set	N/A
SNDRERR0	72	Recovery from alarm sounder error	HW FAULT
SNDRERR1	71	Alarm sounder error	HW FAULT
STACK	56	Stack overflow detected	RESET
SYNC ER1	36	Stepper motor lost sync occurred	HW FAULT
SYNCER0	37	Stepper motor lost sync exited	HW FAULT
TBN ESTP	46	Turbine emergency stop occurred	HIGH PRES
TBN HSTP	66	Turbine Hold Stop occurred	HIGH PRES
TBN ISTOP	44	Turbine immediate stop occurred	HIGH PRES
TBN ZERO	45	Turbine set to zero flow occurred	HIGH PRES
VENT 0	02	Power off	None
VENT 1	01	Power on	None
VENT CHK	04	Set vent check	Entered VENT CHECK mode
WDOG TST	59	Watchdog test run	Inop
XDC FLT0	20	XDCR fault exited	XDCR FAULT
XDC FLT1	19	XDCR fault occurred	XDCR FAULT
XDCR AIR	64	Airway pressure transducer fault	XDC FLT1
XDCR BI	63	Differential pressure transducer - Bi-directional channel fault	XDC FLT1
XDCR NAR	61	Differential pressure transducer - Narrow channel fault	XDC FLT1
XDCR WID	62	Differential pressure transducer - Wide channel fault	XDC FLT1

Appendix F - GLOSSARY

TERM	DEFINITION
AC	Alternating Current.
Airway circuit	The airway tubing that connects the ventilator and the patient.
Airway pressure	The airway pressure measured at the exhalation valve.
Airway pressure display	A bar graph type display composed of 60 LEDs. This display shows the real-time airway circuit pressure from –10 cmH ₂ O to 108 cmH ₂ O.
Alarm	An audible and visual announcement that an alarm condition has been met. Audible notification includes an oscillating or continuous tone. Visual notification may include flashing displays, illuminated LEDs, and text messages shown in the display window.
Apnea	Apnea happens when the time between breath starts exceeds the set apnea interval.
Apnea backup ventilation	Apnea Backup Ventilation begins when an apnea alarm occurs and continues until the patient initiates 2 consecutive breaths or the alarm is canceled by an operator. Apnea Backup Ventilation is given in the Assist / Control mode.
Apnea interval	The maximum period of time allowed between breath starts. If the time between breath starts exceeds this interval, an Apnea alarm occurs.
Assist / Control mode	A mode of ventilation where the patient receives a minimum number of machine and assist breaths. The available breath types are Volume Control and Pressure Control.
Assist breath	A volume or pressure breath that the patient triggers, and which is then controlled and cycled by the ventilator. Assist breaths may occur in Assist / Control and SIMV modes.
Autozero	The procedure for determining the transducer zero offset for ambient pressure.
Bias flow	A constant stream of gas through the patient circuit during the exhalation phase of the breath.
bpm	Breaths Per Minute.
Breath period	The time between consecutive ventilator started breaths. The Breath Period is determined by the Breath Rate per minute setting. For instance, a Breath Rate of 6 would give a Breath Period of 10 seconds (60 seconds divided by 6 bpm).
Breath rate, set	The minimum quantity of machine breaths given in a minute.
BTPD	Body Temperature, Pressure Dry.
Circuit	See airway circuit.
Circuit pressure	See airway pressure.
cmH₂O	Centimeters of water. A unit of measure for pressure.

TERM	DEFINITION
Control mode	A ventilation mode where the ventilator delivers machine breaths at a set rate. In Control Mode, patient triggers are not allowed.
CPAP	Continuous Positive Airway Pressure. The ventilator continuously maintains Positive gas pressure through the patient circuit during the entire breath cycle.
CPAP mode	A ventilation mode where the patient triggers all breaths. Available breath types are Pressure Support and Spontaneous.
Display window	A set of 12 dot-matrix displays used to show monitored data, alarm messages and Extended Feature menu items.
EEPROM	Electrically Erasable Programmable Read Only Memory. Nonvolatile electronic memory that is used by the ventilator to maintain calibration data, control setting and other data when power is not applied to the ventilator.
Event	Any condition noted in the ventilator's event trace. This may include both error conditions and normal operational events.
Exhaled tidal volume	See Tidal Volume.
Expiratory hold	A maneuver which holds the expiratory phase of a delivered breath for a duration sufficient to determine the AutoPEEP of a patient.
Extended features	A set of ventilator controls and options that are not associated with front panel controls. Extended Features are accessed through a menu shown in the display window.
f	See Total Breath Rate, monitored.
Flow	The velocity of gas delivery to the patient, quantified in lpm.
Flow trigger	A patient effort in which the amount of bias flow routed into the patient's lungs exceeds the Sensitivity setting. A flow trigger will result in delivery of an Assist or Patient breath, according to the ventilation mode.
I:E ratio, monitored	The ratio of the inspiration period to the expiration period for a breath. The lesser value is normalized to 1.
I:E ratio, calculated	Calculated Inspiratory:Expiratory ratio, based upon the Inspiratory Time setting and the Breath Rate setting
Inspiratory hold	A maneuver which holds the inspiratory phase of a volume delivered breath for a duration sufficient to determine Δ Pres pressure and static lung compliance of the patient.
L	Liters
Leak compensation	Leak Compensation improves triggering when a circuit leak is present.
LED	Light Emitting Diode. An indicator that is illuminated on the front panel.
lpm	Liters Per Minute. Flow rate.
Machine breath	A volume or pressure breath that is started by the operator or the ventilator, and is controlled and cycled by the ventilator. Machine Breaths may occur in Control and Assist / Control modes. The operator may cause a machine breath in any mode using the Manual Breath Button.

TERM	DEFINITION
Manual breath	A Machine Breath initiated by the operator pushing the Manual Breath Button.
MAP	Mean Airway Pressure.
Mean airway pressure, monitored	The average airway pressure over a series of breaths.
Minimum exhalation time	The minimum time required for exhalation is 346 msec. Control settings are limited to ensure the Minimum Exhalation Time is provided. Breaths may not be triggered during the Minimum Exhalation Time.
Minimum inspiratory time	The minimum time required for inspiration is 300 msec. Control settings are limited to ensure the Minimum Inspiratory Time is provided.
Minute volume, monitored (VE)	The total volume exhaled by the patient for the last 60 seconds. VE is refreshed at the conclusion of each breath and is based on the last 8 breaths.
msec	Millisecond: One one-thousandth of a second.
Non-volatile memory	Memory that is retained when ventilator is in Standby mode or powered off.
O₂	Oxygen.
Patient breath	A Pressure Support or Spontaneous breath that is started by the patient, controlled by the ventilator and cycled by the patient. Patient breaths may occur in SIMV and CPAP ventilation modes.
Patient effort	Inspiratory effort by the patient.
Peak inspiratory pressure, monitored (PIP)	The maximum circuit pressure occurring during the inspiration and first 300 ms exhalation phase of a breath. PIP is measured at the patient wye.
PEEP	Positive End Expiratory Pressure.
PIP	Peak Inspiratory Pressure.
Positive end expiratory pressure, monitored (PEEP)	The circuit pressure measured at the end of exhalation. PEEP is set using the mechanical PEEP valve on the exhalation valve.
POST	Power On Self Tests. A set of self-tests the ventilator performs when turned on to verify the operational integrity of the Processor, Displays, Audible Alarm, Confirming Audible Chirp ⁹⁸ , SRAM, Program Memory and EEPROM (some tests require operator visual and/or audible verification).
Pressure control breath	A machine or assist breath where the circuit pressure is elevated to a operator-set pressure for a operator-set period of time. Pressure Control breaths have an optional flow termination criteria.

⁹⁸ Only on ventilators with an audio sound symbol (🔊) on the back panel label.

TERM	DEFINITION
Pressure support breath	A patient breath where the circuit pressure is raised to an operator-set pressure and maintained until flow decreases to an operator-set percentage of the peak flow achieved. Pressure Support Breaths ⁹⁹ may also be terminated by an operator-set maximum time, or by exceeding 2 breath periods.
PSIG	Pounds per Square Inch Gauge. A unit for measuring pressure.
rpm	Revolutions per minute. Turbine speed is measured in rpm.
Scrolling, monitored data display	Displays the monitored values statically or allows for automatic scrolling. While scrolling is active, each monitored value will be displayed for 3 seconds then the next value will be automatically displayed.
SIMV	Synchronized Intermittent Mandatory Ventilation.
SIMV mode	A ventilation mode where a minimum number of machine or assist breaths are given, and the patient is allowed to trigger additional Patient breaths. Available breath types are volume control, pressure control, pressure support, and spontaneous.
Spontaneous breath	A breath which the patient starts and cycles. Spontaneous breaths are cycled at 10% of peak flow, set variable time termination, or when they exceed 2 breath periods.
Tidal volume, monitored (Vte)	The exhaled volume quantified at the patient wye. Exhaled volume is measured for all breath types.
Total breath rate, monitored (f)	The quantity of breaths given per minute; includes all breath types.
Transducer	A measuring device. Transducers can be used to quantify flow or pressure.
Vcalc	A monitor that displays the calculated peak flow for volume control breaths. Vcalc is calculated based on the set tidal volume and the set inspiratory time.
VE	See minute volume, monitored.
Volume control breath	A machine or assist breath where a operator-set volume is delivered over a operator-set time. Flow is delivered in a decelerating waveform where the peak and final flows are calculated so that the final flow is 50% of the peak flow.
Vte	See tidal volume, monitored.

⁹⁹ Pressure Control and Pressure Support breaths do not compensate for PEEP. Delivered pressure is controlled by the Pressure Control setting and is not affected by the PEEP setting. i.e.; A Pressure Control setting of 20cmH₂O and a PEEP setting of 10cmH₂O results in a maximum delivered pressure of 20cmH₂O.

Appendix G - INDEX

A

AC Adapter · 14-2
AC Power Source · 14-2
Active Alarm · 6-30
Airway Pressure Display · *See Displays:Airway Pressure*
ALARM · 11-3, 15-21
Alarm Clearing · 6-30
ALARM OP · 10-3
Alarm Operations · 10-3
Alarm Silencing · 6-30
Alarm Status Messages
 f PEEP OFF · 9-27
 HI PEEP OFF · 9-27
 LMV LPPS OFF · 9-28
 LMV OFF · 9-28
 LOCKED · 9-29
 LPPS OFF · 9-29
 WARMUP xx · 9-30
Alarm Test · 11-3, 15-21
ALARM VOL · 10-3, 15-21
Alarm Volume · 10-3, 15-21
Alarms
 APNEA · 4-2, 4-3, 9-2, 10-4
 APNEA xx bpm · 4-2, 4-3, 9-2
 BAT EMPTY · 9-3
 BAT LOW · 9-5
 DEFAULTS · 9-7, 15-19
 DEFAULTS SET · 9-9
 DISC/SENSE · 9-10, 15-17, 15-18
 HIGH f · 9-11
 HIGH O₂ PRES · 9-12, 15-2
 HIGH PEEP · 9-13
 HIGH PRES · 6-4, 9-14, 10-4, 15-2, 15-16
 HW FAULT · 9-16, 13-2, 15-18
 INOP · 9-17
 LOCKED · 5-7
 LOW MIN VOL · 6-11, 9-18, 15-2
 LOW O₂ PRES · 9-19, 15-2
 LOW PRES · 6-12, 9-20, 10-4, 15-2
 NO CAL · 8-1, 9-21
 NO CAL DATA · 9-21, 15-18
 POWER LOST · 1-5, 9-22, 14-6
 POWER LOW · 9-23
 REMOVE PTNT · 9-24
 RESET · 9-25, 15-18
 XDCR FAULT · 9-26, 15-18
Apnea · 4-2, 4-3, 9-2
Apnea Backup · 4-2, 4-3, 4-4, 9-2
Apnea Backup Rate · 4-4
APNEA INT · 10-4
Apnea Interval · 4-4, 10-4

APNEA xx bpm · 4-2, 4-3, 9-2
Assist / Control Mode · 4-1
Assist/Control/SIMV/CPAP Mode · 6-1
Audible Alarm Test · 11-3
Audible Alarm Volume · 10-3
Autocycling · 15-5
Automatic High O₂ Switch Over · 6-13, 9-12
Automatic Scrolling · 8-2
Automobile Cigarette Lighter Adapter · 14-8
Autozero · 9-26, 10-23

B

Backup Pressure Trigger · *See Triggers*
BAT EMPTY · 9-3
BAT LOW · 9-5
Battery · *See Internal or External Battery*
Battery Charge Status · 7-4, 14-1
Battery Level · 7-2
Bias Flow · 4-6
Blanked Controls, Displays · 5-5
Boot, Installation · C-6
Boot, Removal · C-3
Boots · C-2
Breath Type
 Pressure Control · 3-3
 Pressure Support · 3-5
 Spontaneous · 3-6
 Volume Control · 3-2
Button Controls · 5-3

C

Calculated Peak Flow · 6-31, 8-2, 8-4
Calibration · B-1
Car Lighter Adapter · 14-8
Cautions · iv
Charge Status · 7-4, 14-1, 14-11
Checklist, Ventilator Settings · 12-10
Checkout Tests · 11-1
Cigarette Lighter Adapter · 14-8
Cleaning · 13-1
 Exhalation Valve · 13-7
 Fan Filter · 13-2
 Inlet Filter · 13-3
 O₂ Inlet Filter · 13-4
 Reusable Patient Circuit · 13-7
 Water Trap · 13-7
Clearing Alarms · *See Alarms:Clearing*
Com Port · C-15
COM SETTING · 10-16
Communications Port · C-15

Communications Setting · 10-16, C-15
Connecting to a Patient · 12-2
Continuous Flow · *See Bias Flow*
CONTROL · 11-6
Control Lock · 5-7, 6-3, 9-29, 15-3
Control Mode · 4-1
Control Test · 11-6
Control Unlock · 10-15
Controls · 5-1, 5-2, 5-3, 6-1
 Assist/Control/SIMV/CPAP Mode · 6-1
 Blank · 5-5
 Dashes · 5-6
 Dimmed · 5-5, 15-3
 Flashing · 5-6
 High Pressure Limit · 14-5, 15-2
 Inspiratory Time · 6-10
 Limiting · 5-6
 Lock · 5-7, 6-3, 9-29, 10-15, 15-3
 Low Minute Volume · 6-11, 15-2
 Low Pressure · 6-12, 15-2
 Low Pressure O₂ Source · 6-13, 9-12
 Manual Breath · 6-17
 O₂% (O₂ Flush) · 6-18, 15-2, 15-4
 On / Standby · 6-20
 PEEP Valve · 6-21
 Pressure Control · 6-23, 15-2
 Pressure Support · 6-25, 15-2
 Select · 6-27
 Sensitivity · 6-28
 Set Value Knob · 5-3, 6-29
 Setting · 5-2
 Silence / Reset · 6-30
 Tidal Volume · 6-31
 Unlock · 10-15
 Volume / Pressure Mode · 6-32, 15-4
CPAP Mode · 4-3
CRC · 15-18
CTRL UNLOCK · 10-15, 15-4

D

Dashes in Display · 5-6
Date · 10-17, 10-18
DATE FORMAT · 10-18
Decelerating Waveform · 3-2, 6-31
Default Controls Settings · 9-8
Default Extended Features Settings · 9-8
DEFAULTS · 9-7, 15-19
DEFAULTS SET · 9-9
Dimmed Controls, Displays · 5-5, 15-3
DISC/SENSE · 9-10, 15-17, 15-18
Disconnect, Sense Line · 9-10
DISPLAY · 11-4
Display Language · 10-15
Display Select · 7-1, 11-7, A-1
Display Test · 11-4
Display Window · 7-1
Displays · 5-1, 7-1
 Airway Pressure · 7-1, 10-19
 Battery Level · 7-2
 Blank · 5-5
 Charge Status · 7-4

Dashes · 5-6
Dimmed · 5-5, 15-3
External Power · 7-5
Flashing · 5-6
NPPV Mode · 7-6
Patient Effort · 7-6
Vent Inop · 7-6
Window · 7-1

E

Effort LED · 6-28
EMC · iii
ET Tube · 15-23
Event Codes · E-3
Event Trace · E-3
EVENT TRACE · E-1
Exhalation Valve · 13-7
 Cleaning · 13-7
Exhaled Minute Volume · 8-4
Exhaled Tidal Volume · 8-2, 8-4
EXP HOLD · 6-5, A-1
Expiratory Hold · 6-5, 6-8, A-1, F-2
Extended Features · 5-3, 6-27, 6-29
 Navigation · 10-2
External Battery · 14-3
 Disposal · 14-4
External Power · 7-5, 14-4, 14-9

F

f · 8-2, 8-3
f PEEP OFF · 9-27
Fan Filter · 13-2
Filter
 O₂ Inlet · 13-4
Flashing Controls, Displays · 5-6
FLOW TERM · 3-4, 3-5, 6-23, 6-25, 10-9, 10-11
Flow Trigger · *See Triggers*

H

Help · 2-3, B-2
HI PEEP OFF · 9-27
HIGH f · 9-11, 10-5, 15-19
HIGH O₂ PRES · 9-12, 15-2
HIGH PEEP · 9-13, 10-5, 15-19
HIGH PRES · 6-4, 9-14, 10-4, 15-2, 15-16, 15-17
High Pressure Alarm Delay · *See HP DELAY*
High Pressure Limit · 14-5, 15-2
High Rate Alarm · *See HIGH f*
Hours in Operation · 10-16
HP DELAY · 10-4, 15-16
Humidifier · C-11
HW FAULT · 9-16, 13-2, 15-18

I

IE Ratio · 8-2, 8-4
Inactive Alarm · 6-30
Inlet Filter · 13-3
INOP · 9-17
INSP HOLD · 6-5, A-1
Insp/Exp · 6-5, 6-6, 6-8
Inspiratory Hold · 6-6, A-1, F-2
Inspiratory Time · 6-10
Inspiratory/Expiratory · 6-5, 6-6, 6-8, 9-8, A-1
Internal Battery · 14-11
 Battery Life · 14-11
 Charge Status · 14-11
 Charging · 14-11
 Disposal · 14-11

L

LANGUAGE · 10-15
LEAK · 11-8
Leak Compensation · F-2
Leak Test · 11-8
Limiting · 5-6, 15-3
LMV LPPS OFF · 9-28
LMV OFF · 9-28
LOCKED · 5-7, 9-29, 15-3
LOW MIN VOL · 6-11, 9-18, 15-2
Low Minute Volume · 6-11, 9-18, 15-2
LOW O₂ PRES · 9-19, 15-2
Low Peak Pressure Alarm · *See LPP ALARM, See Low Pressure Alarm*
LOW PRES · 6-12, 9-20, 10-4, 15-2
Low Pressure Alarm · 6-12, 10-4, 15-2
Low Pressure O₂ Source · 6-13, 9-12
LPP ALARM · 6-12, 10-4
LPPS OFF · 9-29
LTM Compatibility · 10-19
LTM Graphics Monitor · C-15
LTV1000 · 10-19
LTV900 · 10-19
LTV950 · 10-19

M

Maintenance · B-1
Manometer · *See Displays:Airway Pressure*
Manual Breath Button · 6-17
MAP · 8-2, 8-3
Mean Airway Pressure · 8-2, 8-3
Message Window · *See Displays:Window*
Minimum Exhalation Time · 3-1
Minimum Inspiratory Time · 3-1
Minute Volume · 8-2, 8-4
Mode Buttons · 5-3
Model Number · 10-19
Modes · 4-1
 Apnea Backup · 4-2, 4-3, 4-4
 Assist / Control · 4-1
 Control · 4-1

CPAP · 4-3
NPPV · 4-5, 10-13
Pressure · 4-6, 6-32
SIMV · 4-2
 Volume · 4-6, 6-32
Monitor Window · *See Displays:Window*
Monitored Data · *See Monitors*
Monitored Data Displays · 6-27, 8-2
Monitors · 6-27
 Calculated Peak Flow · 8-2, 8-4
 Exhaled Minute Volume · 8-4
 Exhaled Tidal Volume · 8-2, 8-4
 f · 8-3
 IE Ratio · 8-2, 8-4
 MAP · 8-2, 8-3
 Mean Airway Pressure · 8-2, 8-3
 Minute Volume · 8-2
 NO CAL · 9-21, 15-18
 Peak Inspiratory Pressure · 8-2, 8-3
 PEEP · 8-2, 8-3
 PIP · 8-2, 8-3
 Total Breath Rate · 8-2, 8-3
 Vcalc · 8-2, 8-4
 VE · 8-2, 8-4
 Vte · 8-2, 8-4

N

NIST Adapter · C-13
NO CAL · 8-1, 9-21, 15-18
NO CAL DATA · 9-21, 15-18
Non-Invasive Positive Pressure Ventilation · See NPPV mode
NPPV Mode · 4-5, 10-13
 Indicator · 7-6
Nurse Call · *See Patient Assist Call*

O

O₂ Bleed In · 6-16
O₂ Cylinder Duration · 10-21
O₂ Flush · 10-14
O₂ Inlet Filter · 13-4
O₂% · 15-2
O₂% (O₂ Flush) · 6-18, 15-4
On / Standby Button · 6-20
Operating Procedures · 12-1
 Connect to a Patient · 12-2
Operating Theory · D-1
Oxygen
 Blending · 6-18
 Concentration, Bleed In · 6-16
 Concentrator · 6-13
 Connecting · C-13
 Source · 2-2

P

Patient Assist Call · C-14

Patient Assist Call System · 15-20
Patient Circuit
 Connecting · C-10
 Humidifier · C-11
Patient Connection · 12-2
Patient Effort · 6-28, 7-6
PC FLOW TERM · 3-4, 6-23, 10-9, 10-11, 15-2
Peak Flow · 6-31
Peak Inspiratory Pressure · 8-2, 8-3
PEEP Valve · 6-21
PEEP, Monitored · 8-2, 8-3
PIP · 8-2, 8-3, 10-19
PIP LED · 10-19
PNT ASSIST · 10-6, 15-19, 15-20
Positive End Expiratory Pressure · *See PEEP, Monitors:PEEP*
POST · 15-18
POWER LOST · 1-5, 9-22, 14-6
POWER LOW · 9-23
Power Source · 2-2, 14-1
 AC · 14-2
 Automobile Cigarette Lighter Adapter · 14-8
 External Battery · 14-3
Pressure Control · 6-23, 15-2
Pressure Control Breath · 3-3
Pressure Control Flow Termination · *See PC FLOW TERM*
Pressure Mode · 4-6, 6-32
Pressure Support · 6-25, 15-2
Pressure Support Breath · 3-5
Pressure Trigger · *See Triggers*
Preventative Maintenance · B-1
Protective Boot, Installation · C-6
Protective Boot, Removal · C-3
Protective Boots · C-2

R

Real Time Transducers · 10-27
Remote Alarm Cable · C-16
Remote Alarm System · 15-19
REMOVE PTNT · 9-24, 11-2
RESET · 9-25, 15-18
Reusable Patient Circuit Cleaning · 13-7
RISE TIME · 3-3, 6-23, 6-25, 10-8
Rise Time Profile · *See RISE TIME*
RT XDCR DATA · 10-27, 15-5
RUNAWAY · 15-18

S

Scrolled Automatically · 9-27, 9-28, 9-29
Scrolling · 8-2, F-4
Select Button · 6-27
Sensitivity · 6-28
Serial Number · 10-19
Service · 2-3, B-2
SET DATE · 10-17
Set Defaults · 10-20
SET TIME · 10-18
Set Value Knob · 6-29

Setting a Control · *See Controls:Setting*
Settings, Ventilator Checklist · 12-10
Silence / Reset Button · 6-30
Silence Period · 6-30
Silencing Alarms · *See Alarms:Silencing*
SIMV Mode · 4-2
Software Version · 10-16
Specifications · A-1
Spontaneous Breath · 3-6
STACK · 15-18
Standby · 6-20
Sterilizing · 13-1

T

Taper Waveform · 3-2, 6-31
Test
 Alarm · 15-21
Tidal Volume · 6-31, 8-4
Time · 10-18
TIME TERM · 3-5, 6-25, 10-10, 15-2
Total Breath Rate · 8-2, 8-3
Transducer Autozero · 10-23
Transport Battery System · 14-10
Triggers · 3-1, 4-6, 6-28, 7-6
Troubleshooting · 15-1

U

Universal Power Supply kit · 14-10
Unlock · 10-15, 15-3, 15-4
Usage Meter · 10-16
USAGE xxxxx.x · 10-16

V

Valve Home Position · 10-20
Variable Flow Termination · *See FLOW TERM*
Variable Rise Time · *See RISE TIME*
Variable Time Termination · *See TIME TERM*
Vcalc · 8-2, 8-4
VE · 8-2, 8-4
VENT CHECK · 11-2
 exit · 11-12
VENT CHECK Menu · 11-1
Vent Inop · 7-6
Vent Inop Alarm Test · 11-10
VENT OP · 10-7
Vent Operations · 10-7
Ventilator Checkout · C-18
Ventilator Checkout Test
 Alarm Test · 11-3
 Control Test · 11-6
 Display Test · 11-4
 Leak Test · 11-8
 Vent Inop Alarm Test · 11-10
Ventilator Checkout Tests · 11-1
Ventilator Proper Operation Checkout
 Worksheet · C-20

VER xx.xx X · 10-16
VHome · 10-20, 15-6, 15-7, 15-9, 15-11
Volume / Pressure Mode · 6-32, 15-4
Volume Control Breath · 3-2
Volume Mode · 4-6, 6-32
Vte · 8-2, 8-4

W

WARMUP xx · 9-30
Warnings · iv

Warranty · ii
Water Trap Cleaning · 13-7
Waveform · 3-2, 6-31
Worksheets
 Ventilator Proper Operation Checkout · C-20

X

XDCR FAULT · 9-26, 15-18
XDCR ZERO · 10-23, 15-6, 15-7, 15-8, 15-9, 15-10,
15-12