

## LED Strips

### Benefits:

- For indoor & outdoor use
- Lifetime up to 30,000 hrs.
- Up to 80% energy saving
- Lower maintenance cost
- UV & IR free light
- CRI>80
- 5 meters/Roll
- Available:  
IP20, IP65, IP67, IP68  
ww, nw, cw, RGB, CCT adjustable  
3528, 5050, 2835, 5630



### Applications:

- Linear light
- Indirect lighting
- Shops, stores
- Residential
- Restaurants, bars
- Hotels
- Garden, outdoor
- Offices



### General Characteristics:

Item	Watt/M	Lumen/LED	Voltage	CCT (K)	Width	Beam Angle
3528 Flexible Strip	2.4W-19.2W	Up to 6-7Lm	12V/24V	WW, NW, CW RGB CCT Adjustable	5mm-6mm- 8mm-10mm-15mm	120°
5050 Flexible Strip	7.2W-28.8W	Up to 18-20Lm	12V/24V	WW, NW, CW RGB CCT Adjustable	10mm-12mm-20mm	120°
2835 Flexible Strip	7W-40W	Up to 22-24Lm	12V/24V	WW, NW, CW RGB CCT Adjustable	6mm-8mm-10mm 12mm-20mm-30mm	120°
5630 Flexible Strip	9.6W-24W	Up to 40-45Lm	12V/24V	WW, NW, CW RGB CCT Adjustable	5mm-8mm-10mm- 12mm-13.5mm	120°



**Please note when installing:**

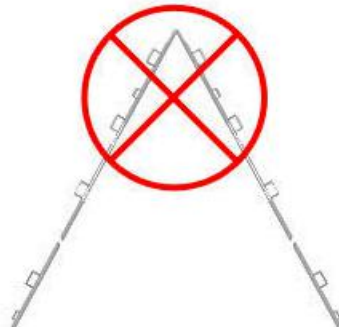
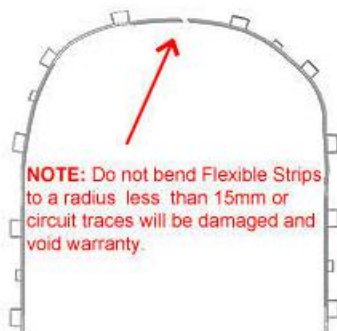

**Cautions:**

- Please read the contents on the box and label carefully before installation
- Check if the specification e.g. voltage, current etc meet the requirements
- Power must be cut off before installation, replacement and cleaning

**Remarks:**

- Power consumption tolerance: +/- 10%.
- Luminous flux & cd tolerance: +/-10%

## LED Strips

### High Voltage

#### Benefits:

- High voltage: 110V, 220V OR 277V
- Up to 80% energy saving
- Lower maintenance cost
- UV & IR free light
- CRI>80
- IP65
- 60LED/M, 120LED/M
- SMD2835, SMD5050, SMD5730
- Up to 35lm/LED
- Single color (white, red, green, blue, yellow), RGB OR CCT adjustable

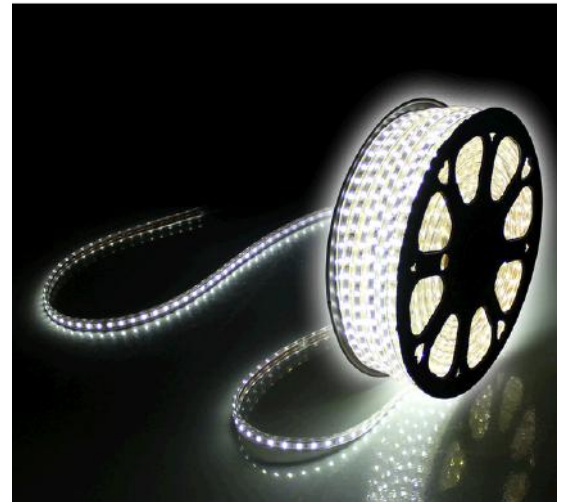

#### Applications:

- Linear light
- Indirect lighting
- Shops, stores
- Residential
- Stairways
- Restaurants, bars
- Hotels
- Garden, outdoor
- Offices
- Under-cabinets

#### General Characteristics:

Item	Watt/M	Lumen/LED	Voltage	CCT (K)	Width/Size	LED Module
HV5050-110V/220V	8-11W	Up to 24lm/LED	110V OR 220V	White, Red, Green, Blue, Yellow RGB CCT adjustable	10mm 15*7mm	SMD5050
HV5050-277V	8-11W	Up to 24lm/LED	277V	White, Red, Green, Blue, Yellow RGB CCT adjustable	10mm 15*7mm	SMD5050
HV5730-110V/220V	9W	Up to 35lm/LED	110V OR 220V	CCT adjustable	12mm 12.5*7-5mm	SMD5730
HV2835-110/220V	5-9W	Up to 22lm/LED	110V OR 220V	White, Red, Green, Blue, Yellow RGB CCT adjustable	8mm 13*7mm 10mm 15*7mm 12mm 17*7mm 12mm 15*7mm	SMD2835



LED strip



Pin joint

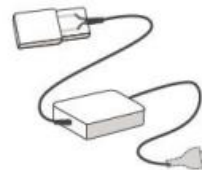

Power plug



End cap



Fixed buckle

**Cautions:**

- Please read the contents on the box and label carefully before installation
- Check if the specification e.g. voltage, current etc meet the requirements
- Power must be cut off before installation, replacement and cleaning

**Remarks:**

- Power consumption tolerance: +/- 10%.
- Luminous flux & cd tolerance: +/-10%

## LED Strips

### Neon Flex

Our LED Neon Flex Strip is a perfect way to give a continuous smooth, linear lighting effect. It is easy to cut, bend and install. Its flexibility can make it easy to bend it into whatever angle or shape needed. This linear light is made of an inner plastic extrusion that houses the series of LED and a plastic outer jacket protecting the inner core. The plastic jacket is translucent colored and the LED's can be in different colors (red, orange, blue, yellow, green, etc) and white tones.

#### Benefits:

- For indoor & outdoor use
- Flexible
- Low heat & safe
- Up to 80% energy saving
- Lower maintenance cost
- UV & IR free light
- CRI>80 or CRI>90
- 50.000 hrs life-span
- Single or double side light emission

#### Applications:

- Reading & task lighting
- Cove lighting
- Accent lighting
- Edge lighting
- Under counter lighting
- Stair lighting

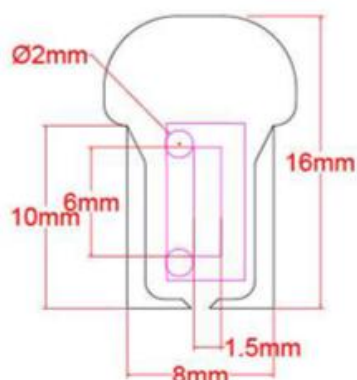
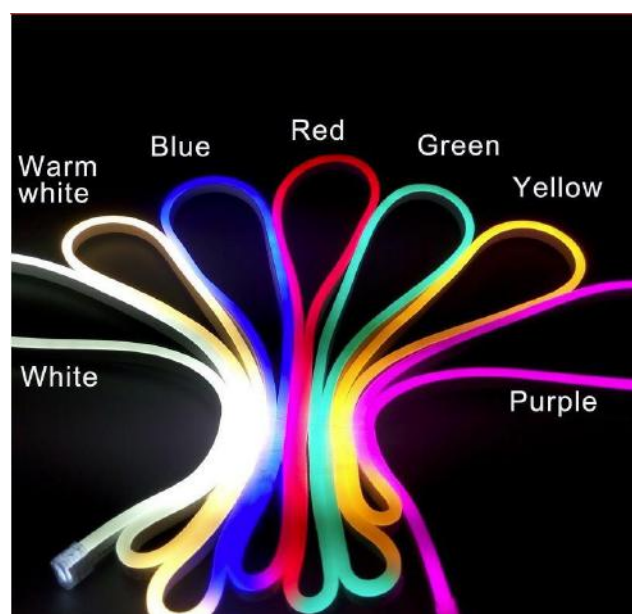

### **Characteristics:**

- 12V, 24V, 120V, 220V, OR 277V\*
- Working am: 15-17mA/meter (220V)
- LED number: 120 LEDs/meter for single colored – 60 LEDs/meter for RGB
- LED: SMD 2835
- Colors: White, warm white, red, green, blue, yellow, pink, purple, RGB
- Beam angle: 120°
- Operation temp.: -40°C up to 80°C
- Body temp.: 40°C up to 60°C
- IP65, IP67, IP68
- Shell material: Integration D shaped PVC
- Accessories: Power cord, male-male plug, U aluminum channel or U PVC channel, metal pin, connector, heat shrink cap, end cap, controller

### **Power/M:**

- Red, Yellow, Blue, Green, White, Warm White, Purple
  - AC220V + 110V – 6W/M
  - DC24V + 12V – 8W/M
- RGB
  - AC220V + 110V – 6W/M
  - DC24V – 11W/M

### **Cutting:**

- Red, Yellow, Blue, Green, White, Warm White, Purple
  - AC220V – 100cm
  - AC110V – 50cm
  - DC24V – 50cm
  - DC12V – 5cm
- RGB
  - AC220V – 100cm
  - AC110V – 50cm
  - DC24V – 50cm

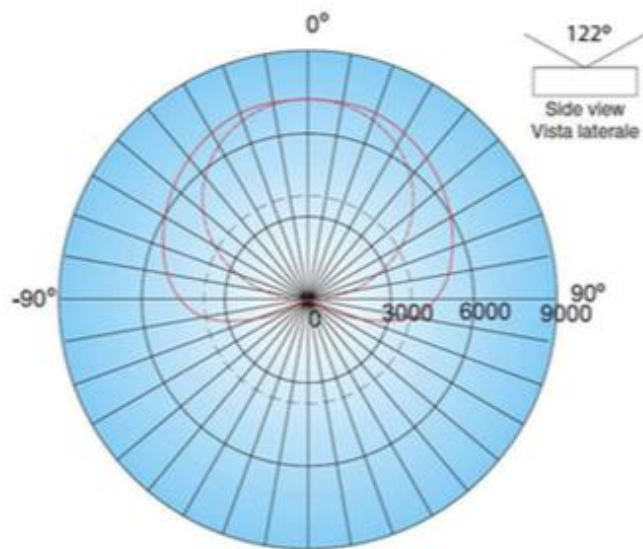
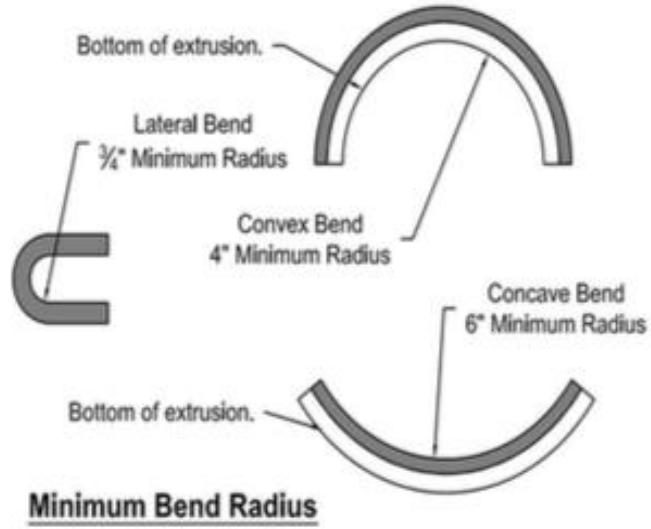

\*Photos, descriptions and details of the product are subject to change without previous notice.  
\*277V special upon request. Size 14\*26mm.